



# FOR RFP ROS.

EMERGENCY LIGHTING AND SAFETY POWER SUPPLY SYSTEMS 2023

MADE IN GERMANY

**RFP GROUP**  
SOLUTIONS IN SAFETY + LIGHTING





**FIVE TIMES CERTIFIED. PROVEN A MILLION TIMES OVER.**

*Safety – made in Germany*

Design and functionality, ease of use and energy efficiency, reliability and durability – products from RP-Technik must meet a wide range of requirements. We develop and manufacture our emergency and safety luminaires and our power supply systems exclusively in Germany. The performance and quality of our products have top priority – for the safety of people and plants.

In our ultra-modern light laboratory with photogoniometer, audited by TÜV Rheinland according to DIN EN 60598-2-22, the light output of individual LED lights is measured and documented. We provide photometric data of our safety luminaires for the planning of projects. Each product complies with the current standards and regulations and passes a strict quality control before delivery.



## PATENTS AND CERTIFICATES – DOCUMENTED INNOVATIVE STRENGTH

We are owners of 53 patents in the field of emergency lighting. Our internal quality assurance system and various certifications ensure that our products meet the highest standards of reliability and safety.

RP-Technik GmbH is successfully certified or recertified according to the following standards: zertifiziert:

- Recertification ISO 9001:2015 for company processes
- ISO 45001:2018 for occupational health and safety
- ISO 14001:2015 for environmental management system
- ISO 50001:2011 for energy management

In addition, a large number of our products are type approved by TÜV Rheinland.

Our systems production in Saalfeld is also subject to strict quality controls and has been certified by TÜV SÜD. Already during production, we test the individual components of the power supply systems. As well, each system is subjected to a 24-hour endurance test before delivery.

Furthermore, we consistently use energy-saving technologies in the development of our products and environmentally friendly, recyclable materials in production.

## DESIGN AND FUNCTIONALITY – AN EXCELLENT COMBINATION

Our internal product design ensures functional aesthetics, for which RP-Technik has already received several awards. In 2016, the OLED escape sign luminaire was awarded the renowned German Design Award and the reddot design award, and in 2018 the new A-series from RP-Technik received the German Design Award in the category „Excellent Product Design, Lighting“.



OLED luminaire



reddot award 2016 winner



A-series





## OUR PRODUCT TRAINING COURSES – COMPACT, CONSTRUCTIVE, CUSTOMIZED

Future-oriented emergency lighting requires competent further training: Our training courses are tailored to the needs of our customers and a clear recommendation for every professional. They consist of teaching important theoretical knowledge combined with a high percentage of hands-on training. We offer the following topics:

- General questions on the installation and set-up of emergency lighting systems in accordance with applicable national and European standards and regulations
- Operation and function of our portfolio of emergency lighting products
- Operation, function and programming of our power supply systems and modules
- Maintenance and service according to applicable regulations
- Troubleshooting



**PLANER-TOOL**  
RATGEBER ZUR PLANUNG VON  
NOT- UND SICHERHEITSELEKTROLICHTUNG

### PLANNING-TOOL

The participants of the planner events carried out together with our premium partners will receive our exclusive and comprehensive guide to the planning of emergency and safety lighting: The Planning Tool.

# CONTENT – EXIT- AND EMERGENCY LUMINAIRES

## GENERAL INFORMATIONEN

Order key .....	6
Legend .....	7
Protection categories .....	8
Piktographs.....	10
Emergency and general lighting from a single source .....	12

## DESIGN LUMINAIRES

OLED .....	16
ASMU .....	20
A-Series .....	24
MMW / MMD .....	70
EE-Series.....	74
EA-Series .....	80
FMW.....	82
FMDS .....	84
WEF.....	86
WER.....	88
WAF.....	90
ZAW.....	92

## DYNAMIC LUMINAIRES

FLEXWAY .....	98
---------------	----

## UNIVERSAL-LUMINAIRES

KM .....	104
KSU .....	108
KSC.....	110
KBU .....	116
KX.....	120
IL.....	124
KMB .....	132
KE .....	136
DO .....	140

## INDUSTRIAL LUMINAIRES

PM .....	146
KC .....	148
KD / KL .....	154
LM / LX / LS .....	160
KWI.....	166
PF .....	170
V2W .....	172
Cube luminaires WH .....	174
Cube luminaires WK / WG / WX.....	178
Cube luminaires WFXW .....	182
Explosion proof luminaires XI / XM / XX.....	184
U6.....	190
SKS / SGS.....	192
HX.....	196

## GENERAL-PURPOSE LIGHTING FOR SAFETY USE

QAW .....	200
QBW.....	202
QCW .....	204
LFD .....	206
FLU .....	208
Recessed-Panel PREMIUM .....	210

## WIRELESS LUMINAIRE MONITORING

Wireless Basic® and Lightlinx® .....	212
Wireless Professional .....	214
Wireless IO-Box .....	217

## ACCESSORIES

Wall brackets and pendant fittings.....	218
Ball protection.....	219

## MODULES

MLED500, NT24.....	224
LPU, LEM, LEX, WRLED.....	225
Self-contained power supply NVG .....	226

# CONTENT – SAFETY POWER SUPPLY SYSTEMS

<b>GENERAL INFORMATIONEN</b>	
Applicable Standards.....	230
The Systems family.....	232
Low Power Systems.....	234
Central Battery Systems.....	236
The CPU.....	242
The Web-Interface.....	244
<b>LOW POWER SYSTEMS</b>	
Core Compact 24.....	246
microControl <i>plus</i> .....	248
miniControl <i>plus</i> .....	250
miniContro XLI <i>plus</i> .....	252
<b>CENTRAL BATTERY SYSTEMS</b>	
midiControl <i>plus</i> .....	254
multiControl <i>plus</i> .....	256
MDC.....	262
<b>SUBSTATIONS AND SUBDISTRIBUTIONS</b>	
multiControl <i>plus</i> US / microControl <i>plus</i> US.....	264
MCUV.....	266
MCUV-E.....	268
<b>ACCESSORIES AND MODULES</b>	
Related accessories per system type.....	270
Mains circuit modules.....	272
Relay circuit module, Charger module.....	273
IO-Module, Switch query module.....	274
Closed current loop, Line monitor.....	275
Remote panel.....	276
Connection to building management systems.....	277
Power down switch.....	278
MU05, UH-1, MU05-BOX.....	279
MLED500.....	280
Battery cabinets.....	281
<b>BATTERIES AND BATTERY MONITORING</b>	
OGiV LP.....	282
OGiV FT.....	286
OGiV HP.....	288
BAT-LOGG® Battery monitoring.....	290
System dimensioning.....	294

# ORDER KEY

The cases shown on the following pages are empty casings, the order numbers which are composed of the casing description and the method of mounting. Colour options for the casings are available at additional cost.

## Order key according to mounting technique

- W = Wall mounting
- D = Ceiling/Outrigger mounting  
(wall bracket must be ordered separately)
- U = Universal mounting wall / ceiling
- E = Recessed mounting
- C = recessed ceiling mounting
- R = recessed wall mounting

### Lenses

- F = focused lens for corridors
- R = radiate lens
- H = high bay lens
- S = spot lens
- L = system lens (corridor / radial)

### Monitoring options

- ML = monitoring / luminaire monitoring
- SC = Self-Control monitoring
- WL = Wireless Professional monitoring
- WB = Wireless Basic® monitoring
- CC = Core Compact 24V-system

The order numbers of casings with light fittings are composed of the order number of the case type, the order number of the chosen fitting and if necessary the number of the monitoring module. The order numbers for the fittings can be found in the respective type table

## Light-fittings order key

001	EB *	LED LowPower, 1h
003	EB *	LED LowPower 3h
011	EB *	LED HighPower 1h
013	EB *	LED HighPower 3h
018	EB *	LED HighPower 8h
023	EB *	ERT (Escape Route Type) LED / 3h
028	EB *	ERT (Escape Route Type) LED / 8h
033	EB *	ERT (Escape Route Type) LED / 3h
009	CBS * 230V	LED LowPower
019	CBS * 230V	LED HighPower
029	CBS * 230V	ERT (Escape Route Type) LED
039	CBS * 230V	ERT (Escape Route Type) LED
024	CBS * 24V	LED LowPower
124	CBS * 24V	LED HighPower
224	CBS * 24V	ERT (Escape Route Type) LED
401	EB * - LiFePo4	LED LowPower, 1h
403	EB * - LiFePo4	LED LowPower 3h
408	EB * - LiFePo4	LED LowPower 8h
411	EB * - LiFePo4	LED HighPower 1h
413	EB * - LiFePo4	LED HighPower 3h
418	EB * - LiFePo4	LED HighPower 8h
421	EB * - LiFePo4	ERT (Escape Route Type) LED / 1h
423	EB * - LiFePo4	ERT (Escape Route Type) LED / 3h
428	EB * - LiFePo4	ERT (Escape Route Type) LED / 8h
433	EB * - LiFePo4	ERT (Escape Route Type) LED / 3h

\*EB = Self-Contained | \*CBS = Central Battery Systems



Order number

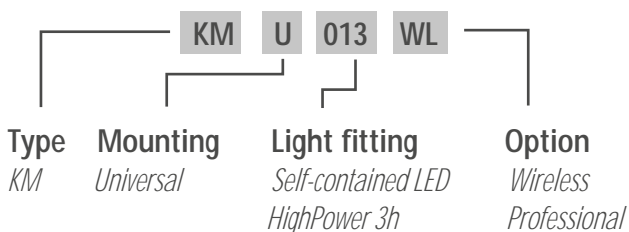

Order number

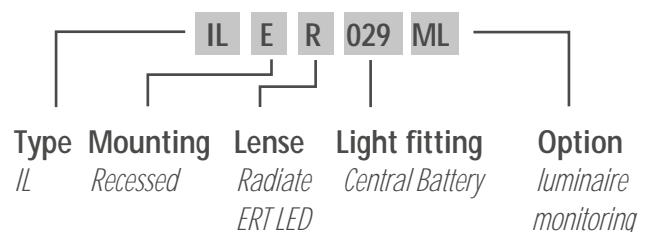



# LEGEND

	Insulation class I; PE conductor connection required		Ball protection available
	Insulation class II; luminaire is insulated		Recessed mounting frame available
	ENEC certified luminaire		Wall bracket available
	Recognition distance in meters		Ballproof luminaire
	Universal mounting on wall or ceiling possible.		Optional accessory design pendant fitting
	Complete set of pictographs included (left / right/ up / down)		Optional accessory standard double pendant fitting white (2DW) or silver (2PV).
	IK-Shock resistance level		Optional accessory cord suspension (standard length 0.5m).
	Luminaire suitable for use in explosive dust atmospheres		Luminaire may be monitored with central battery systems.
	Light planning data of the luminaire are available.		Self-contained luminaire with integrated automated self testing module – Self-Control.
	Protection class		Luminaire is available with radio module for connection to the Wireless Professional system.
	5 years warranty on electronics, LED and battery		Luminaire is switchable with the Wireless Professional system.
	Type approved product		Luminaire is available with radio module for connection to the Wireless Basic system.
	Food safe		Luminaire for connection to a 24V Core Compact central battery system.
	Version		max. power consumption
	Emergency operating time of the luminaire (CBS = Central battery system)		Luminous flux in emergency mode
	Colour options		Battery data

**Note:** „max. consumption“ refers to the maximum power consumption (for example, including battery charge) of the luminaire.

# INTERNATIONAL PROTECTION CLASSES

## ACCORDING TO DIN EN 60529

















Code letters International Protection		First index Contact protection	Second index Protection against water		
Ziffer		Protection	Ziffer	Protection	
IP		6	5		
0		No protection against accidental contact, no protection against solid foreign bodies	0		No protection against water
1		Protection against contact with any large area by hand and against solid foreign bodies with $\varnothing > 50$ mm	1		Protection against vertical water drips
2		Protection against contact with the fingers, protection against solid foreign bodies with $\varnothing > 12$ mm	2		Protection against water drips (up to a 15° angle)
3		Protection against tools, wires or similar objects with $\varnothing > 2,5$ mm, protection against solid foreign bodies with $\varnothing > 2,5$ mm	3		Protection against water drips (up to a 60° angle)
4		As 3, however $\varnothing > 1$ mm	4		Protection against splashed water from all directions
5		Full protection against contact, protection against interior dust deposits	5		Protection against water (out of a nozzle) from all directions
6		Total protection against contact, protection against penetration of dust	6		Protection against powerful water jets
			7		Protection against temporary immersion
			8		Protection against water pressure

diagram in accordance with  
DIN EN 60529 (VDE 0470-1):2014-09  
EN 60529:1991 + A1:2000 + A2:2013

## IK - IMPACT RESISTANCE GRADE



The IK impact resistance rating is a measure of the resistance of components to impact and shock loads. According to the international standard IEC 62262 or EN 62262, it describes degrees of protection provided by housings for electrical equipment (equipment) against external mechanical stress.

Code	Impact energy in joules	Corresponds to the fall height of the mass
IK00	no protection	
IK01	0,14	7 cm – 200 g
IK02	0,20	8 cm – 250 g
IK03	0,35	14 cm – 250 g
IK04	0,50	20 cm – 250 g
IK05	0,70	28 cm – 250 g
IK06	1,0	40 cm – 250 g
IK07	2,0	40 cm – 500 g
IK08	5,0	25 cm – 2 kg
IK09	10,0	20 cm – 5 kg
IK10	20,0	40 cm – 5 kg
IK10+	50,0	50 cm – 10 kg

# ONE LUMINAIRE THAT FITS ALL NEEDS

## Former order method

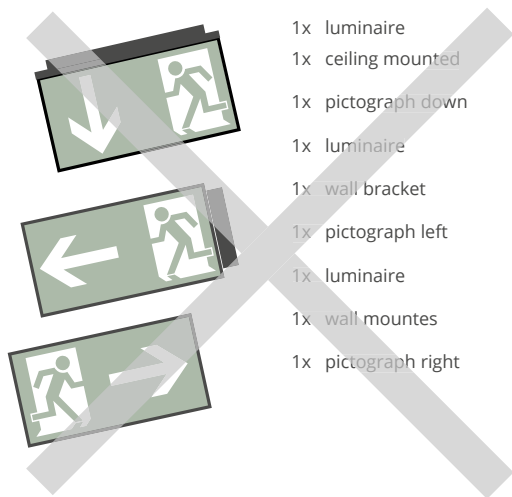

- 1x luminaire
- 1x ceiling mounted
- 1x pictograph down
- 1x luminaire
- 1x wall bracket
- 1x pictograph left
- 1x luminaire
- 1x wall mountes
- 1x pictograph right

Our products feature the latest technology. Many of our luminaires can be mounted universally and are delivered with a complete set of pictographs. This saves you time and prevents inconvenient planning. You just have to order the needed number of luminaires - no extra orders for pictographs or mounting equipment.

## Our order method

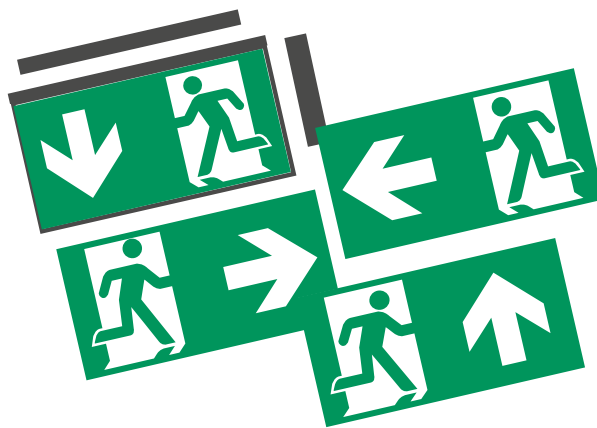

3x luminaire, universal mounting  
incl. complete set of pictographs

### Benefits for planners

- Only one order needed for all mounting types and pictographs

### Benefits for distributors

- Less storage space required
- Only one type in stock
- Less administration costs

### Benefits for installers

- Flexible handling - even while mounting the device



Pay attention to these symbols for luminaires which feature universal mounting and / or are delivered with a complete set of pictographs.

# PICTOGRAPHS



01 MTU  
escape route straight

02 MTL  
escape route left

03 MTR  
escape route right

15 MTO  
escape route straight on



05 TLO \*  
upstairs left

06 TLU \*  
downstairs left

07 TRO \*  
upstairs right

08 TRU \*  
downstairs right

Examples: special labeling based on customer preference \*

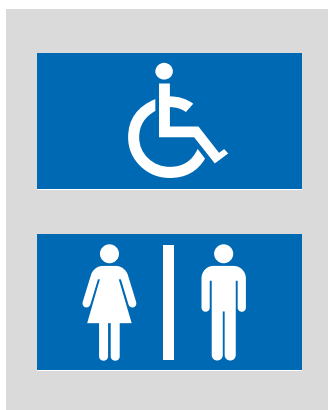

Pictographs according to DIN 4844-2 T1+2 DIN EN 7010, DIN ISO 3864-1 and new BGV A8 as well as NFPA/LifeSafetyCode.

If you would like to order pictographs individually, please indicate the luminaire type.

Non-standard pictographs are available at additional charge, though delivery times might be longer.



Fire extinguisher \*  
special pictograph, silk-screen print or cutted foil

Fire alarm \*  
special pictograph, silk-screen print or cutted foil

Fire hose \*  
special pictograph, silk-screen print or cutted foil

Fire fighting Equipment \*  
special pictograph, silk-screen print or cutted foil

Also available as a pictograph set for midsized edge luminaires



Defibrillator \*  
special pictograph, silk-screen print or cutted foil

First Aid \*  
special pictograph, silk-screen print or cutted foil

Collection point \*  
special pictograph, silk-screen print or cutted foil

Emergency exit with escape ladder \*  
special pictograph, silk-screen print or cutted foil

Also available as a pictograph set for the KSC luminaire

Basically all kinds of labeling are possible, also multicolored.

Please send object drawings in vector format, otherwise the post-processing must be cleared by time.

Material for use: acrylic glass (standard), glass and float-glass.

DESIGN LUMINAIRES

DYNAMIC LUMINAIRES

UNIVERSAL LUMINAIRES

INDUSTRIAL LUMINAIRES

GENERAL LIGHTING WITH EMERGENCY LIGHT

WIRELESS MONITORING

ACCESSORIES

MODULES

\* = Special pictographs (Additional price)

# EMERGENCY AND GENERAL LIGHTING FROM A SINGLE SOURCE.

Are you looking for a holistic lighting solution for buildings that includes general lighting in addition to emergency and safety lighting? Maybe even including smart control options? With the modular RP light system we offer you one flexible complete solution from a single source.

As an innovation leader and one of the market leaders in the field of emergency and safety lighting, we have many years of experience in the project business. Many of our customers want special solutions with a tailor-made combination of emergency and general lighting. That's why we supply you with individual complete solutions for your project from a single source that meet the highest standards of safety, efficiency, design, innovation and quality.

Our updated program for general lighting includes attractive lights that are supplemented by modules for emergency lighting functions or smart control options depending on the installation location, use and individual requirements.



**RP luminaire with RP Inside**  
RP light with emergency and safety light function



**RP luminaire pure**  
for general lighting

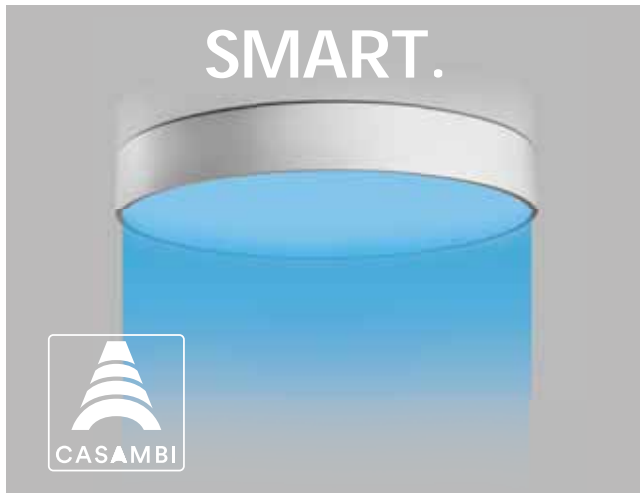

**RP luminaire with CASAMBI Inside**  
with smart control options

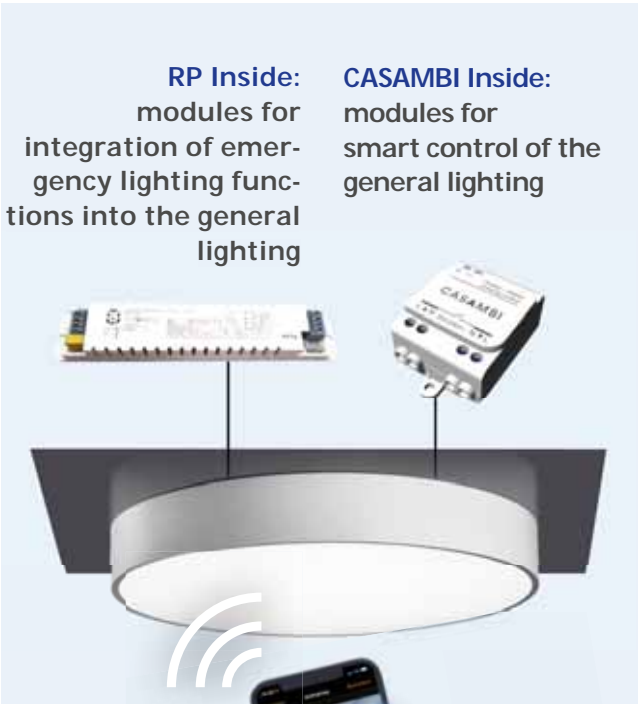

**RP Inside:**  
modules for  
integration of emer-  
gency lighting func-  
tions into the general  
lighting

**CASAMBI Inside:**  
modules for  
smart control of the  
general lighting

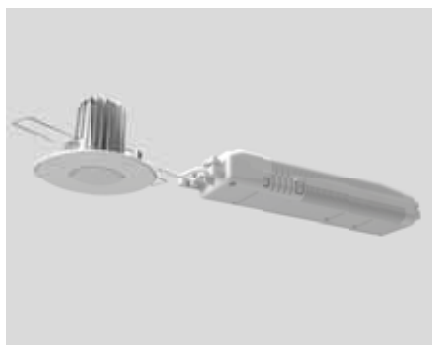

## DDE

The powerful LED safety light DDE, with up to 1100lm in emergency operation, is particularly suitable for workplaces with a particular risk or as anti-panic lighting. It meets the emergency lighting requirements of DIN EN 60598- 1, DIN EN 60598-222 and DIN EN 1838.

Both the radiator and the heat sink are made of high-quality die-cast zinc. The material used ensures good heat dissipation and a long service life of the LED. The tension springs mounted on the product make assembly much easier. Due to its small installation dimensions (ceiling cut-out of 68mm), the spotlight is ideal as a supplement to commercially available recessed lights.

Due to its particular luminosity, the spotlight is the first choice for applications with high ceilings, such as in hotels or in cinemas or event rooms.



## TRILUX Lichtband

Together with leading providers of LED light line solutions, we offer solutions with integrated escape signs or safety lights for specific applications across many sectors and areas of application.

The solutions are preconfigured and tested. So you can be used directly in many places.



## UEMR

This frameless recessed escape sign luminaire for wall level is both functional and design-oriented: a simple appearance combined with user-friendly levelling and mounting.

- Mtal mounting frame for installation in concrete walls
- As self-contained luminaire or for connection to central battery systems (with or without monitoring module)

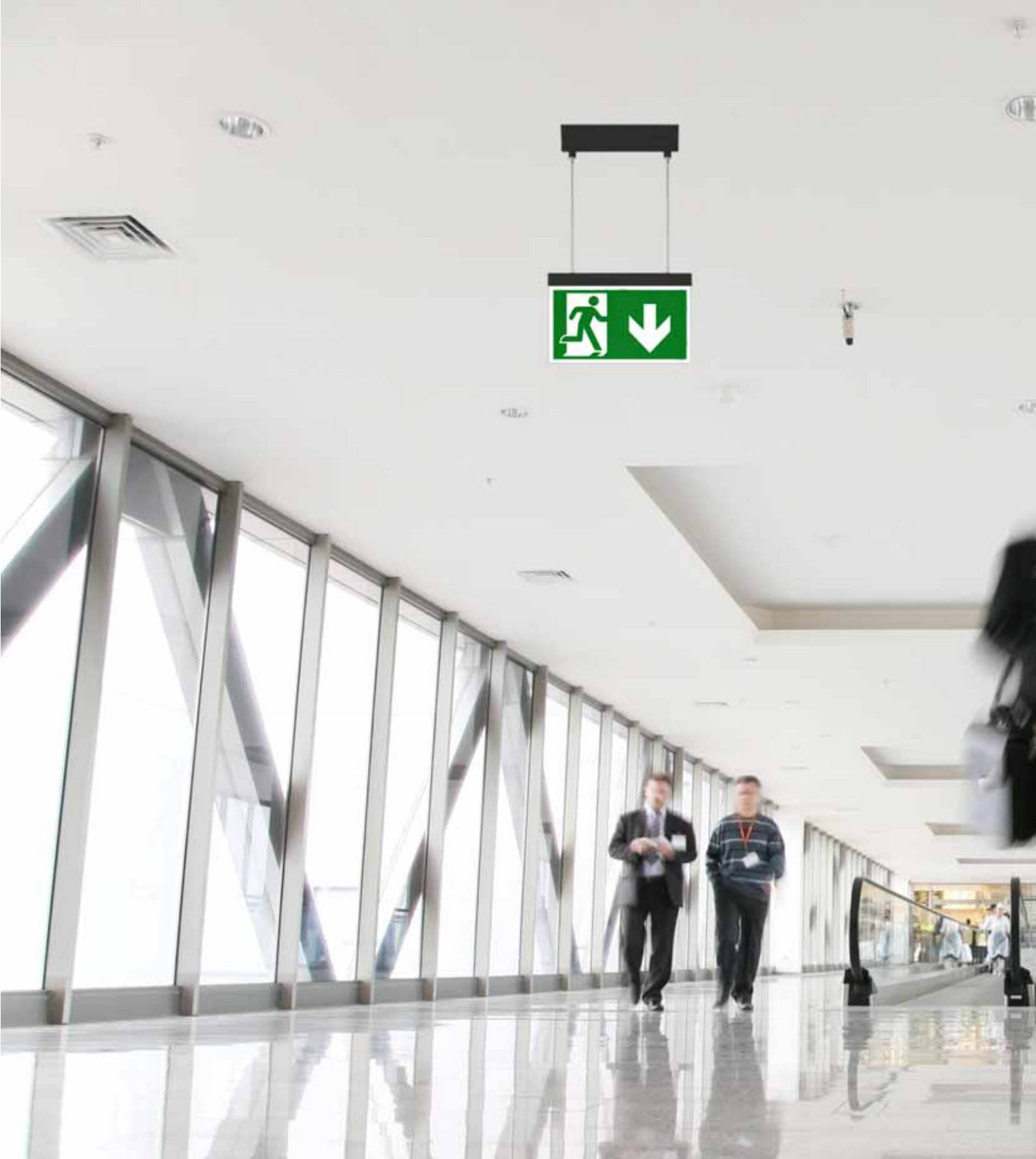

 **DESIGN LUMINAIRES**







 **OLED**  
DESIGN LUMINAIRES

  
reddot award 2016  
winner

  
GERMAN  
DESIGN  
AWARD  
WINNER  
2016



## FACTS

- Aluminized plastic
- 20m Viewing distance
- Complete set of pictographs (ISO 7010)
- IP20
- OLED Illuminant
- Ceiling, recessed ceiling or recessed wall mounting
- -5° to +35°C

Design luminaire for all purposes where elegance plays an important role. It uses as a light source a full-area organic LED or OLED. Thus a 100% homogeneous illumination of the pictogram is achieved.











The housing surface is aluminized in a process as it is already used in the automotive industry. The variably useable and tollessly

changeable pictograms of the OLED provide planning security on site. LED escape route luminaire in accordance with DIN EN 60598-1, EN 60598-2-22, EN 7010 and DIN EN 1838.



## DESIGN LUMINAIRES



						
<b>LUMINAIRES FOR CENTRAL BATTERY SYSTEMS AC/DC INCL. MONITORING MODULE</b>						
OLED - Single sided			OMRS009ML	CPS	3,7 W	
OLED - Single sided	OMDS009ML-AZ *	OMCS009ML		CPS	4 W	
OLED - Double sided	OMDD009ML-AZ *	OMCD009ML		CPS	6,3 W	

\* -AZ: with ceiling mounted housing in anthracite

## RECESSED WALL MOUNTING

Dimensions OLED Recessed wall mounting

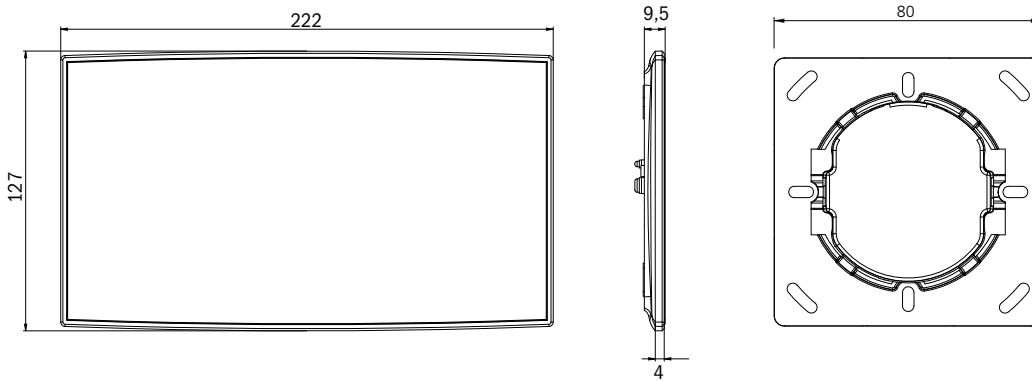

## RECESSED CEILING MOUNTING

Dimensions OLED Recessed ceiling mounting

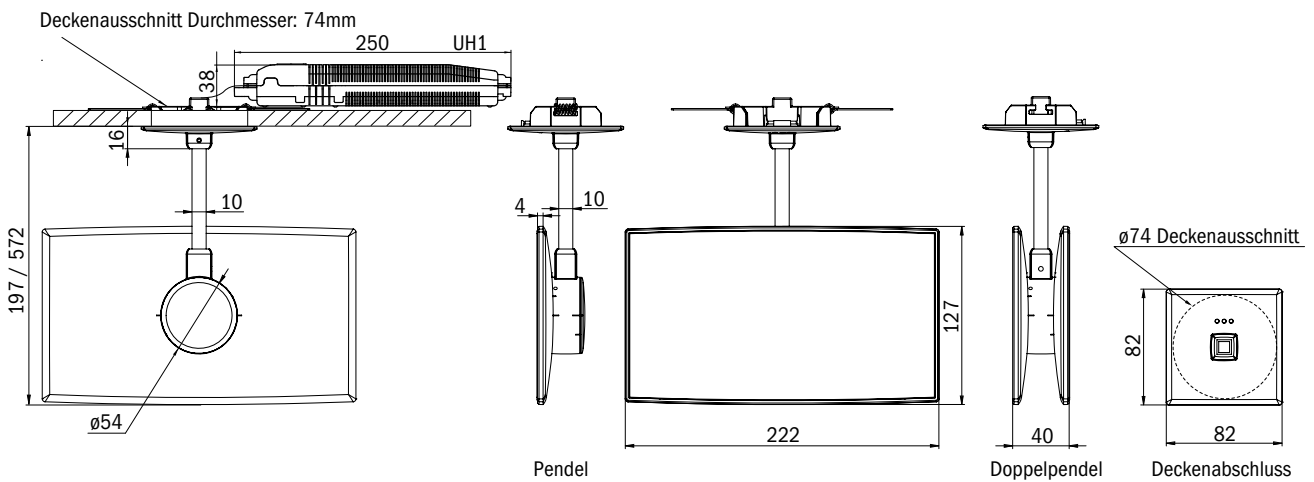

For concrete installation, we recommend the recessed boxes HaloX-0 + HaloX-40 from Kaiser.

## ACCESSORIES



Pendulum 500mm reducible



 **ASMU**  
ALUMINIUM PROFILED EDGE LUMINAIRE



nicht für ASMU001(WL) und ASMU003(SC)

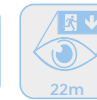

## FACTS

- Aluminium profiled housing, silver or white
- 22m Viewing distance
- Complete set of pictographs (ISO 7010)
- IP40
- LED Illuminant
- Universal mounting
- -5° to +40°C

































Innovative aluminum multifunctional edge LED luminaire for universal mounting (wall/ ceiling). Applicable for maintained or nonmaintained operation mode. Improved reliability through easy to install universal use of pictograms.

Pictogram set (left, right, straight up and down, blind) included. Signs according to EN 60598-1, EN 60598-2-22 and EN 1838 norms.



ASMU-W

## ALUMINIUM PROFILED EDGE LUMINAIRE

	 	 				
<b>SELF-CONTAINED LUMINAIRES WITH SELFCONTROL MODULE</b>						
LED, 1h, 230V AC	ASMU011SC	ASMU011SC-WS	1 h		4,6 W	3,2V / 0,57Ah LiFePO4 
LED, 3h, 230V AC	ASMU013SC	ASMU013SC-WS	3 h		4,6 W	3,2V / 0,57Ah LiFePO4 
LED, 3h, 230V AC	ASMU003SC	ASMU003SC-WS	3 h		3,1 W	4,8V / 0,5Ah NiMH 
LED, 8h, 230V AC	ASMU018SC	ASMU018SC-WS	8 h		4,6 W	3,2V / 3,3 Ah LiFePO4 
<b>SELF-CONTAINED LUMINAIRES WITH WIRELESS BASIC MODULE</b>						
LED, 1h, 230V AC	ASMU011WB	ASMU011WB-WS	1 h		5,3 W	3,2V / 3,3 Ah LiFePO4 
LED, 3h, 230V AC	ASMU013WB	ASMU013WB-WS	3 h		5,3 W	3,2V / 3,3 Ah LiFePO4 
LED, 8h, 230V AC	ASMU018WB	ASMU018WB-WS	8 h		5,3 W	3,2V / 3,3 Ah LiFePO4 
<b>SELF-CONTAINED LUMINAIRES WITH WIRELESS PROFESSIONAL MODULE (SWITCHABLE)</b>						
LED, 1h, 230V AC	ASMU001WL	ASMU001WL-WS	1 h		3,6 W	4,8V / 0,5Ah NiMH 
LED, 1h, 230V AC	ASMU011WL	ASMU011WL-WS	1 h		5,3 W	3,2V / 3,3 Ah LiFePO4 
LED, 3h, 230V AC	ASMU013WL	ASMU013WL-WS	3 h		5,3 W	3,2V / 3,3 Ah LiFePO4 
LED, 8h, 230V AC	ASMU018WL	ASMU018WL-WS	8 h		5,3 W	3,2V / 3,3 Ah LiFePO4 
<b>LUMINAIRES FOR CORE COMPACT SYSTEMS 24V AC/DC INCL. MONITORING MODULE</b>						
LED, 24V, AC/DC	ASMU519CC	ASMU519CC-WS	CPS		2,1 W	
<b>LUMINAIRES FOR CENTRAL BATTERY SYSTEMS AC/DC INCL. MONITORING MODULE</b>						
LED, 230V AC/DC	ASMU019ML	ASMU019ML-WS	CPS		3,2 W	





not for ASMU001(WL) and ASMU003(SC)



## UNIVERSAL MOUNTING

Dimensions ASMU

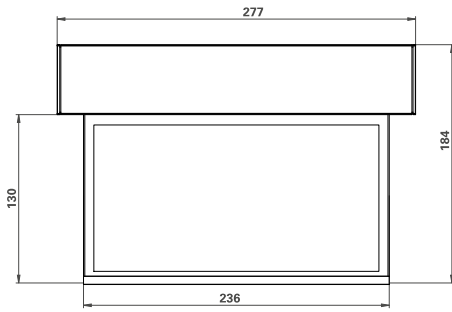

Drilling distances ASMU

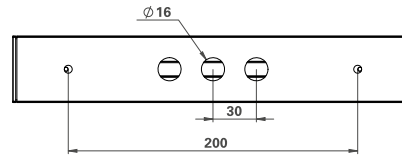

## ACCESSORIES





 **A-Series**  
DESIGN METAL EDGE LUMINAIRES



## FACTS

- Zinc die-cast housing
- Standard white (RAL 9003), anthracite (-AZ) (RAL 7016) or stainless steel look (-E)
- 15m (AI), 22m (AM), 30m (AX) or 50m (AG) Viewing distance
- Complete set of pictographs (ISO 7010)
- IP20 (recessed) or IP40 (surface)
- LED Illuminant
- Wall or ceiling mounting
- -5° to +40°C

The A-series is a complete product line of high quality exit signs with metal housing for surface or recessed mounting. The entire series has been designed in the same style and can be perfectly integrated into any environment.

The A-series is characterized by sober, clear lines and is only noticeable when it comes to the worst.

The installation of the Zinc die-cast luminaires is simple. All clamps and screw connections are easily accessible at all times. No screw connections are visible from the outside on mounted luminaires.

All luminaires of the A series are available in 2 sizes. The AM offers a detection range of 22m, while the larger AX has a detection range of 30m.

The uniform illumination of the pictogram is ensured by a dot matrix grid printed on the screen.

The type of mounting of the luminaire is indicated by the 3rd and, if appropriate, the fourth letter of the order number.

The luminaires with duo technology offer a light output downwards by means of an additional LED on the electronics housing. These luminaires are therefore perfect for illuminating the area of doors and passages. In normal operation, the pictogram is illuminated using conventional high power LEDs. In emergency operation, an automatic switchover to the integrated ERT LED is performed to illuminate the escape route and the pictogram.

All A-series luminaires are available as standard in white or in anthracite and with stainless-steel look.

The LED exit signs are built according to DIN EN 60598-1, DIN EN 60598-2-22, DIN EN 7010 and DIN EN 1838.



## RECESSED CEILING MOUNTING - CIRCULAR CUT-OUT



### AI - VIEWING DISTANCE 15M

SELF-CONTAINED LUMINAIRES WITH SELFCONTROL MODULE							
LED, 1h, 230V AC	AIE001SC	AIE001SC-AZ	AIE001SC-E	1 h	3,7 W	4,8V/2,0Ah NiMH	
LED, 3h, 230V AC	AIE003SC	AIE003SC-AZ	AIE003SC-E	3 h	3,7 W	4,8V/2,0Ah NiMH	
LED, 8h, 230V AC	AIE008SC	AIE008SC-AZ	AIE008SC-E	8 h	3,7 W	4,8V/2,0Ah NiMH	
LUMINAIRES FOR CENTRAL BATTERY SYSTEMS AC/DC INCL. MONITORING MODULE							
LED, 230V AC/DC	AIE009ML	AIE009ML-AZ	AIE009ML-E	CPS	2,25 W		

## RECESSED CEILING MOUNTING

Dimensions AI recessed ceiling mounting AIE

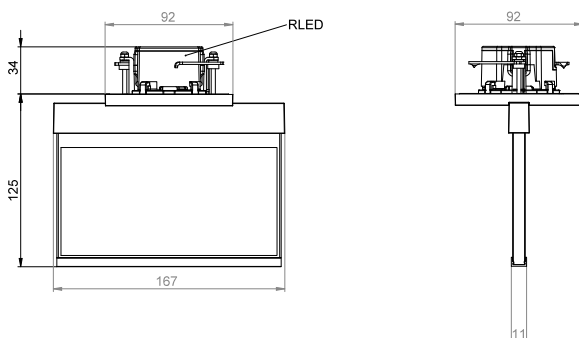

Self-contained electronics box (UH-1)

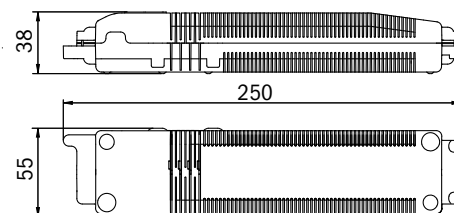



## RECESSED CEILING MOUNTING WITH PENDULUM - CIRCULAR CUT-OUT



### AI - VIEWING DISTANCE 15M

SELF-CONTAINED LUMINAIRES WITH SELFCONTROL MODULE							
LED, 1h, 230V AC	AIEP001SC	AIEP001SC-AZ	AIEP001SC-E	1 h	3,7 W	4,8V/2,0Ah NiMH	
LED, 3h, 230V AC	AIEP003SC	AIEP003SC-AZ	AIEP003SC-E	3 h	3,7 W	4,8V/2,0Ah NiMH	
LED, 8h, 230V AC	AIEP008SC	AIEP008SC-AZ	AIEP008SC-E	8 h	3,7 W	4,8V/2,0Ah NiMH	
LUMINAIRES FOR CENTRAL BATTERY SYSTEMS AC/DC INCL. MONITORING MODULE							
LED, 230V AC/DC	AIEP009ML	AIEP009ML-AZ	AIEP009ML-E	CPS	2,25 W		

### RECESSED CEILING MOUNTING

Dimensions AI recessed ceiling mounting AIEP

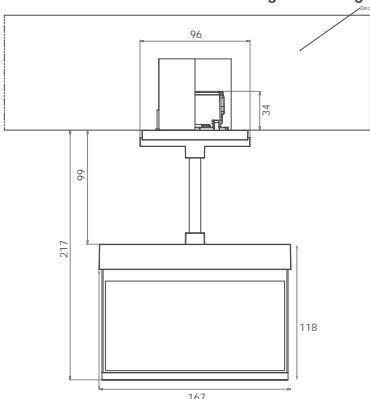

Pendulum can be shortened

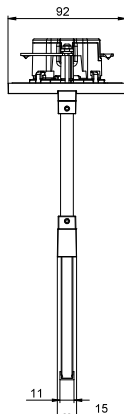

Self-contained electronics box (UH-1)

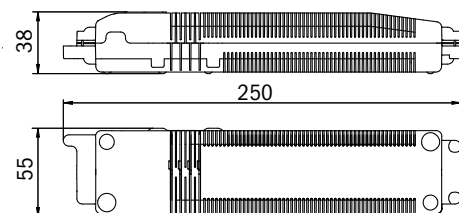

## RECESSED WALL MOUNTING CIRCULAR CUT-OUT



### AI - VIEWING DISTANCE 15M

SELF-CONTAINED LUMINAIRES WITH SELFCONTROL MODULE							
LED, 1h, 230V AC	AIR001SC	AIR001SC-AZ	AIR001SC-E	1 h	3,7 W	4,8V/2,0Ah NiMH	
LED, 3h, 230V AC	AIR003SC	AIR003SC-AZ	AIR003SC-E	3 h	3,7 W	4,8V/2,0Ah NiMH	
LED, 8h, 230V AC	AIR008SC	AIR008SC-AZ	AIR008SC-E	8 h	3,7 W	4,8V/2,0Ah NiMH	
LUMINAIRES FOR CENTRAL BATTERY SYSTEMS AC/DC INCL. MONITORING MODULE							
LED, 230V AC/DC	AIR009ML	AIR009ML-AZ	AIR009ML-E	CPS	2,25 W		

## RECESSED WALL MOUNTING

Dimensions AI Recessed wall mounting AIR

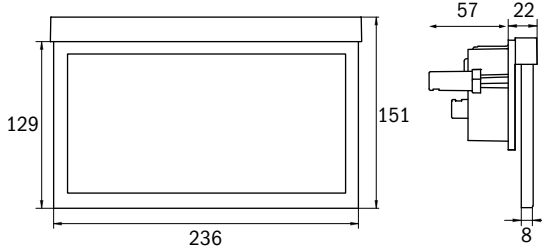

Self-contained electronics box (UH-1)

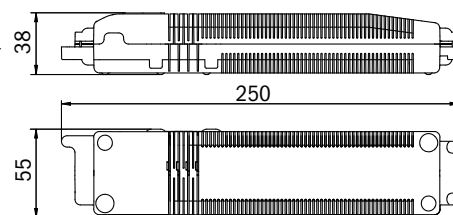



## WALL MOUNTING



### AI - VIEWING DISTANCE 15M

<b>SELF-CONTAINED LUMINAIRES WITH SELFCONTROL MODULE</b>							
LED, 1h, 230V AC	AIW001SC	AIW001SC-AZ	AIW001SC-E	1 h	3,7 W	4,8V/2,0Ah NiMH	
LED, 3h, 230V AC	AIW003SC	AIW003SC-AZ	AIW003SC-E	3 h	3,7 W	4,8V/2,0Ah NiMH	
LED, 8h, 230V AC	AIW008SC	AIW008SC-AZ	AIW008SC-E	8 h	3,7 W	4,8V/2,0Ah NiMH	
<b>LUMINAIRES FOR CENTRAL BATTERY SYSTEMS AC/DC INCL. MONITORING MODULE</b>							
LED, 230V AC/DC	AIW009ML	AIW009ML-AZ	AIW009ML-E	CPS	2,25 W		

### WALL MOUNTING



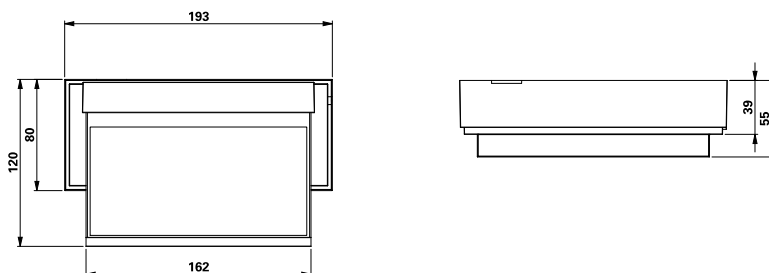









Dimensions wall mounting AIW

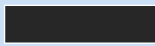

## WALL MOUNTING



## AM – VIEWING DISTANCE 22M

								
								
<b>SELF-CONTAINED LUMINAIRES WITH SELFCONTROL MODULE</b>								
LED, 1h, 230V AC	AMW001SC	AMW001SC-AZ	AMW001SC-E	1 h	4,7 W	4,8V/2,0Ah NiMH		
LED, 3h, 230V AC	AMW003SC	AMW003SC-AZ	AMW003SC-E	3 h	4,7 W	4,8V/2,0Ah NiMH		
LED, 8h, 230V AC	AMW008SC	AMW008SC-AZ	AMW008SC-E	8 h	4,6 W	4,8V/2,0Ah NiMH		
<b>SELF-CONTAINED LUMINAIRES WITH WIRELESS PROFESSIONAL MODULE (SWITCHABLE)</b>								
LED, 1h, 230V AC	AMW401WL	AMW401WL-AZ	AMW401WL-E	1 h	4,7 W	3,2V / 1,2 Ah LiFePO4		
LED, 3h, 230V AC	AMW403WL	AMW403WL-AZ	AMW403WL-E	3 h	4,7 W	3,2V / 1,2 Ah LiFePO4		
<b>LUMINAIRES FOR CENTRAL BATTERY SYSTEMS AC/DC</b>								
LED, 230V AC/DC	AMW009	AMW009-AZ	AMW009-E	CPS	2,4 W			
<b>LUMINAIRES FOR CENTRAL BATTERY SYSTEMS AC/DC INCL. MONITORING MODULE</b>								
LED, 230V AC/DC	AMW009ML	AMW009ML-AZ	AMW009ML-E	CPS	3,5 W			





# AX W

## WALL MOUNTING



### AX – VIEWING DISTANCE 30M

<b>SELF-CONTAINED LUMINAIRES WITH SELFCONTROL MODULE</b>							
LED, 1h, 230V AC	AXW001SC	AXW001SC-AZ	AXW001SC-E	1 h	5,7 W	4,8V/2,0Ah NiMH	
LED, 3h, 230V AC	AXW003SC	AXW003SC-AZ	AXW003SC-E	3 h	5,7 W	4,8V/2,0Ah NiMH	
LED, 8h, 230V AC	AXW008SC	AXW008SC-AZ	AXW008SC-E	8 h	5,6 W	4,8V/2,0Ah NiMH	
<b>SELF-CONTAINED LUMINAIRES WITH WIRELESS PROFESSIONAL MODULE (SWITCHABLE)</b>							
LED, 1h, 230V AC	AXW401WL	AXW401WL-AZ	AXW401WL-E	1 h	5,6 W	3,2V / 1,2 Ah LiFePO4	
LED, 3h, 230V AC	AXW403WL	AXW403WL-AZ	AXW403WL-E	3 h	5,6 W	3,2V / 1,2 Ah LiFePO4	
<b>LUMINAIRES FOR CENTRAL BATTERY SYSTEMS AC/DC</b>							
LED, 230V AC/DC	AXW009	AXW009-AZ	AXW009-E	CPS	3,3 W		
<b>LUMINAIRES FOR CENTRAL BATTERY SYSTEMS AC/DC INCL. MONITORING MODULE</b>							
LED, 230V AC/DC	AXW009ML	AXW009ML-AZ	AXW009ML-E	CPS	4,5 W		

GENERAL INFORMATION

DESIGN LUMINAIRES

DYNAMIC LUMINAIRES

UNIVERSAL LUMINAIRES

INDUSTRIAL LUMINAIRES

GENERAL LIGHTING WITH EMERGENCY LIGHT

WIRELESS MONITORING

ACCESSORIES

MODULES

## RECESSED WALL MOUNTING



### AM – VIEWING DISTANCE 22M

<b>SELF-CONTAINED LUMINAIRES WITH SELFCONTROL MODULE</b>							
LED, 1h, 230V AC	AMR001SC	AMR001SC-AZ	AMR001SC-E	1 h	4,7 W	4,8V/2,0Ah NiMH	
LED, 3h, 230V AC	AMR003SC	AMR003SC-AZ	AMR003SC-E	3 h	4,7 W	4,8V/2,0Ah NiMH	
LED, 8h, 230V AC	AMR008SC	AMR008SC-AZ	AMR008SC-E	8 h	4,6 W	4,8V/2,0Ah NiMH	
<b>SELF-CONTAINED LUMINAIRES WITH WIRELESS PROFESSIONAL MODULE (SWITCHABLE)</b>							
LED, 1h, 230V AC	AMR401WL	AMR401WL-AZ	AMR401WL-E	1 h	4,7 W	3,2V / 1,2 Ah LiFePO4	
LED, 3h, 230V AC	AMR403WL	AMR403WL-AZ	AMR403WL-E	3 h	4,7 W	3,2V / 1,2 Ah LiFePO4	
<b>LUMINAIRES FOR CENTRAL BATTERY SYSTEMS AC/DC</b>							
LED, 230V AC/DC	AMR009	AMR009-AZ	AMR009-E	CPS	2,4 W		
<b>LUMINAIRES FOR CENTRAL BATTERY SYSTEMS AC/DC INCL. MONITORING MODULE</b>							
LED, 230V AC/DC	AMR009ML	AMR009ML-AZ	AMR009ML-E	CPS	3,5 W		



# AX R

GENERAL INFORMATION

## RECESSED WALL MOUNTING



DESIGN LUMINAIRES

DYNAMIC LUMINAIRES

UNIVERSAL LUMINAIRES

### AX – VIEWING DISTANCE 30M

<b>SELF-CONTAINED LUMINAIRES WITH SELFCONTROL MODULE</b>							
LED, 1h, 230V AC	AXR001SC	AXR001SC-AZ	AXR001SC-E	1 h	5,7 W	4,8V/2,0Ah NiMH	
LED, 3h, 230V AC	AXR003SC	AXR003SC-AZ	AXR003SC-E	3 h	5,7 W	4,8V/2,0Ah NiMH	
LED, 8h, 230V AC	AXR008SC	AXR008SC-AZ	AXR008SC-E	8 h	5,6 W	4,8V/2,0Ah NiMH	
<b>SELF-CONTAINED LUMINAIRES WITH WIRELESS PROFESSIONAL MODULE (SWITCHABLE)</b>							
LED, 1h, 230V AC	AXR401WL	AXR401WL-AZ	AXR401WL-E	1 h	5,6 W	3,2V / 1,2 Ah LiFePO4	
LED, 3h, 230V AC	AXR403WL	AXR403WL-AZ	AXR403WL-E	3 h	5,6 W	3,2V / 1,2 Ah LiFePO4	
<b>LUMINAIRES FOR CENTRAL BATTERY SYSTEMS AC/DC</b>							
LED, 230V AC/DC	AXR009	AXR009-AZ	AXR009-E	CPS	3,3 W		
<b>LUMINAIRES FOR CENTRAL BATTERY SYSTEMS AC/DC INCL. MONITORING MODULE</b>							
LED, 230V AC/DC	AXR009ML	AXR009ML-AZ	AXR009ML-E	CPS	4,5 W		

INDUSTRIAL LUMINAIRES

GENERAL LIGHTING WITH EMERGENCY LIGHT

WIRELESS MONITORING

ACCESSORIES

MODULES

## CEILING MOUNTING



### AM – VIEWING DISTANCE 22M

<b>SELF-CONTAINED LUMINAIRES WITH SELFCONTROL MODULE</b>									
LED, 1h, 230V AC	AMD001SC	AMD001SC-AZ	AMD001SC-E	1 h	4,7 W	4,8V/2,0Ah NiMH			
LED, 3h, 230V AC	AMD003SC	AMD003SC-AZ	AMD003SC-E	3 h	4,7 W	4,8V/2,0Ah NiMH			
LED, 8h, 230V AC	AMD008SC	AMD008SC-AZ	AMD008SC-E	8 h	4,6 W	4,8V/2,0Ah NiMH			
<b>SELF-CONTAINED LUMINAIRES WITH WIRELESS PROFESSIONAL MODULE (SWITCHABLE)</b>									
LED, 1h, 230V AC	AMD401WL	AMD401WL-AZ	AMD401WL-E	1 h	4,7 W	3,2V / 1,2 Ah LiFePO4			
LED, 3h, 230V AC	AMD403WL	AMD403WL-AZ	AMD403WL-E	3 h	4,7 W	3,2V / 1,2 Ah LiFePO4			
<b>LUMINAIRES FOR CENTRAL BATTERY SYSTEMS AC/DC</b>									
LED, 230V AC/DC	AMD009	AMD009-AZ	AMD009-E	CPS	2,4 W				
<b>LUMINAIRES FOR CENTRAL BATTERY SYSTEMS AC/DC INCL. MONITORING MODULE</b>									
LED, 230V AC/DC	AMD009ML	AMD009ML-AZ	AMD009ML-E	CPS	3,5 W				



# AX D

GENERAL INFORMATION

## CEILING MOUNTING

DESIGN LUMINAIRES

DYNAMIC LUMINAIRES

UNIVERSAL LUMINAIRES

INDUSTRIAL LUMINAIRES

GENERAL LIGHTING WITH EMERGENCY LIGHT

WIRELESS MONITORING

ACCESSORIES

MODULES



## AX – VIEWING DISTANCE 30M

<b>SELF-CONTAINED LUMINAIRES WITH SELFCONTROL MODULE</b>							
LED, 1h, 230V AC	AXD001SC	AXD001SC-AZ	AXD001SC-E	1 h	5,7 W	4,8V/2,0Ah NiMH	
LED, 3h, 230V AC	AXD003SC	AXD003SC-AZ	AXD003SC-E	3 h	5,7 W	4,8V/2,0Ah NiMH	
LED, 8h, 230V AC	AXD008SC	AXD008SC-AZ	AXD008SC-E	8 h	5,6 W	4,8V/2,0Ah NiMH	
<b>SELF-CONTAINED LUMINAIRES WITH WIRELESS PROFESSIONAL MODULE (SWITCHABLE)</b>							
LED, 1h, 230V AC	AXD401WL	AXD401WL-AZ	AXD401WL-E	1 h	5,6 W	3,2V / 1,2 Ah LiFePO4	
LED, 3h, 230V AC	AXD403WL	AXD403WL-AZ	AXD403WL-E	3 h	5,6 W	3,2V / 1,2 Ah LiFePO4	
<b>LUMINAIRES FOR CENTRAL BATTERY SYSTEMS AC/DC</b>							
LED, 230V AC/DC	AXD009	AXD009-AZ	AXD009-E	CPS	3,3 W		
<b>LUMINAIRES FOR CENTRAL BATTERY SYSTEMS AC/DC INCL. MONITORING MODULE</b>							
LED, 230V AC/DC	AXD009ML	AXD009ML-AZ	AXD009ML-E	CPS	4,5 W		

## RECESSED CEILING MOUNTING



### AM – VIEWING DISTANCE 22M

<b>SELF-CONTAINED LUMINAIRES WITH SELFCONTROL MODULE</b>								
LED, 1h, 230V AC	AMC001SC	AMC001SC-AZ	AMC001SC-E	1 h	4,7 W	4,8V/2,0Ah NiMH		
LED, 3h, 230V AC	AMC003SC	AMC003SC-AZ	AMC003SC-E	3 h	4,7 W	4,8V/2,0Ah NiMH		
LED, 8h, 230V AC	AMC008SC	AMC008SC-AZ	AMC008SC-E	8 h	4,6 W	4,8V/2,0Ah NiMH		
<b>SELF-CONTAINED LUMINAIRES WITH WIRELESS PROFESSIONAL MODULE (SWITCHABLE)</b>								
LED, 1h, 230V AC	AMC401WL	AMC401WL-AZ	AMC401WL-E	1 h	4,7 W	3,2V / 1,2 Ah LiFePO4		
LED, 3h, 230V AC	AMC403WL	AMC403WL-AZ	AMC403WL-E	3 h	4,7 W	3,2V / 1,2 Ah LiFePO4		
<b>LUMINAIRES FOR CENTRAL BATTERY SYSTEMS AC/DC</b>								
LED, 230V AC/DC	AMC009	AMC009-AZ	AMC009-E	CPS	2,4 W			
<b>LUMINAIRES FOR CENTRAL BATTERY SYSTEMS AC/DC INCL. MONITORING MODULE</b>								
LED, 230V AC/DC	AMC009ML	AMC009ML-AZ	AMC009ML-E	CPS	3,5 W			



# AX C

GENERAL INFORMATION

## RECESSED CEILING MOUNTING

DESIGN LUMINAIRES

DYNAMIC LUMINAIRES

UNIVERSAL LUMINAIRES

INDUSTRIAL LUMINAIRES

GENERAL LIGHTING WITH EMERGENCY LIGHT

WIRELESS MONITORING

ACCESSORIES

MODULES



### AX – VIEWING DISTANCE 30M

<b>SELF-CONTAINED LUMINAIRES WITH SELFCONTROL MODULE</b>				
LED, 1h, 230V AC	AXC001SC	AXC001SC-AZ	AXC001SC-E	1 h, 5,7 W, 4,8V/2,0Ah NiMH
LED, 3h, 230V AC	AXC003SC	AXC003SC-AZ	AXC003SC-E	3 h, 5,7 W, 4,8V/2,0Ah NiMH
LED, 8h, 230V AC	AXC008SC	AXC008SC-AZ	AXC008SC-E	8 h, 5,6 W, 4,8V/2,0Ah NiMH
<b>SELF-CONTAINED LUMINAIRES WITH WIRELESS PROFESSIONAL MODULE (SWITCHABLE)</b>				
LED, 1h, 230V AC	AXC401WL	AXC401WL-AZ	AXC401WL-E	1 h, 5,6 W, 3,2V / 1,2 Ah LiFePO4
LED, 3h, 230V AC	AXC403WL	AXC403WL-AZ	AXC403WL-E	3 h, 5,6 W, 3,2V / 1,2 Ah LiFePO4
<b>LUMINAIRES FOR CENTRAL BATTERY SYSTEMS AC/DC</b>				
LED, 230V AC/DC	AXC009	AXC009-AZ	AXC009-E	CPS, 3,3 W
<b>LUMINAIRES FOR CENTRAL BATTERY SYSTEMS AC/DC INCL. MONITORING MODULE</b>				
LED, 230V AC/DC	AXC009ML	AXC009ML-AZ	AXC009ML-E	CPS, 4,5 W

## RECESSED CEILING MOUNTING WITH CORD SUSPENSION



### AM – VIEWING DISTANCE 22M

<b>SELF-CONTAINED LUMINAIRES WITH SELFCONTROL MODULE</b>							
LED, 1h, 230V AC	AMCC001SC	AMCC001SC-AZ	AMCC001SC-E	1 h	4,7 W	4,8V/2,0Ah NiMH	
LED, 3h, 230V AC	AMCC003SC	AMCC003SC-AZ	AMCC003SC-E	3 h	4,7 W	4,8V/2,0Ah NiMH	
LED, 8h, 230V AC	AMCC008SC	AMCC008SC-AZ	AMCC008SC-E	8 h	4,6 W	4,8V/2,0Ah NiMH	
<b>SELF-CONTAINED LUMINAIRES WITH WIRELESS PROFESSIONAL MODULE (SWITCHABLE)</b>							
LED, 1h, 230V AC	AMCC401WL	AMCC401WL-AZ	AMCC401WL-E	1 h	4,7 W	3,2V / 1,2 Ah LiFePO4	
LED, 3h, 230V AC	AMCC403WL	AMCC403WL-AZ	AMCC403WL-E	3 h	4,7 W	3,2V / 1,2 Ah LiFePO4	
<b>LUMINAIRES FOR CENTRAL BATTERY SYSTEMS AC/DC</b>							
LED, 230V AC/DC	AMCC009	AMCC009-AZ	AMCC009-E	CPS	2,4 W		
<b>LUMINAIRES FOR CENTRAL BATTERY SYSTEMS AC/DC INCL. MONITORING MODULE</b>							
LED, 230V AC/DC	AMCC009ML	AMCC009ML-AZ	AMCC009ML-E	CPS	3,5 W		





## RECESSED CEILING MOUNTING WITH CORD SUSPENSION



### AX – VIEWING DISTANCE 30M

<b>SELF-CONTAINED LUMINAIRES WITH SELFCONTROL MODULE</b>							
LED, 1h, 230V AC	AXCC001SC	AXCC001SC-AZ	AXCC001SC-E	1 h	5,7 W	4,8V/2,0Ah NiMH	
LED, 3h, 230V AC	AXCC003SC	AXCC003SC-AZ	AXCC003SC-E	3 h	5,7 W	4,8V/2,0Ah NiMH	
LED, 8h, 230V AC	AXCC008SC	AXCC008SC-AZ	AXCC008SC-E	8 h	5,6 W	4,8V/2,0Ah NiMH	
<b>SELF-CONTAINED LUMINAIRES WITH WIRELESS PROFESSIONAL MODULE (SWITCHABLE)</b>							
LED, 1h, 230V AC	AXCC401WL	AXCC401WL-AZ	AXCC401WL-E	1 h	5,6 W	3,2V / 1,2 Ah LiFePO4	
LED, 3h, 230V AC	AXCC403WL	AXCC403WL-AZ	AXCC403WL-E	3 h	5,6 W	3,2V / 1,2 Ah LiFePO4	
<b>LUMINAIRES FOR CENTRAL BATTERY SYSTEMS AC/DC</b>							
LED, 230V AC/DC	AXCC009	AXCC009-AZ	AXCC009-E	CPS	3,3 W		
<b>LUMINAIRES FOR CENTRAL BATTERY SYSTEMS AC/DC INCL. MONITORING MODULE</b>							
LED, 230V AC/DC	AXCC009ML	AXCC009ML-AZ	AXCC009ML-E	CPS	4,5 W		

## CEILING MOUNTING WITH CORD SUSPENSION

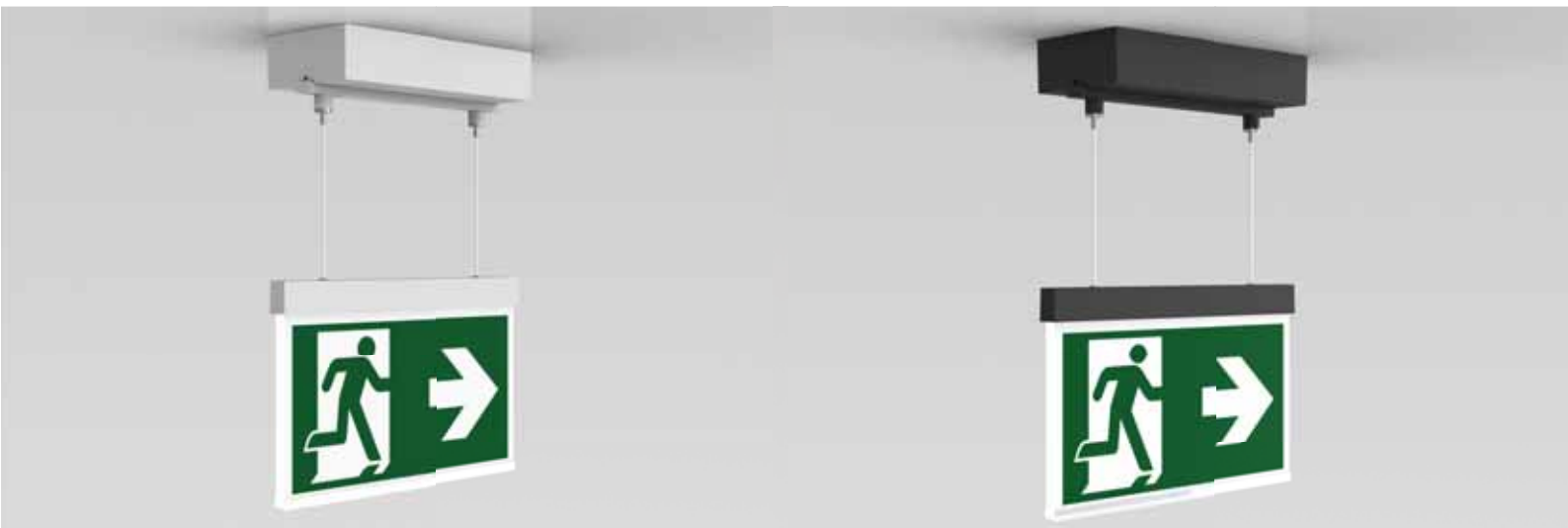

### AM – VIEWING DISTANCE 22M

SELF-CONTAINED LUMINAIRES WITH SELFCONTROL MODULE							
LED, 1h, 230V AC	AMDC001SC	AMDC001SC-AZ	AMDC001SC-E	1 h	4,7 W	4,8V/2,0Ah NiMH	
LED, 3h, 230V AC	AMDC003SC	AMDC003SC-AZ	AMDC003SC-E	3 h	4,7 W	4,8V/2,0Ah NiMH	
LED, 8h, 230V AC	AMDC008SC	AMDC008SC-AZ	AMDC008SC-E	8 h	4,6 W	4,8V/2,0Ah NiMH	
SELF-CONTAINED LUMINAIRES WITH WIRELESS PROFESSIONAL MODULE (SWITCHABLE)							
LED, 1h, 230V AC	AMDC401WL	AMDC401WL-AZ	AMDC401WL-E	1 h	4,7 W	3,2V / 1,2 Ah LiFePO4	
LED, 3h, 230V AC	AMDC403WL	AMDC403WL-AZ	AMDC403WL-E	3 h	4,7 W	3,2V / 1,2 Ah LiFePO4	
LUMINAIRES FOR CENTRAL BATTERY SYSTEMS AC/DC							
LED, 230V AC/DC	AMDC009	AMDC009-AZ	AMDC009-E	CPS	2,4 W		
LUMINAIRES FOR CENTRAL BATTERY SYSTEMS AC/DC INCL. MONITORING MODULE							
LED, 230V AC/DC	AMDC009ML	AMDC009ML-AZ	AMDC009ML-E	CPS	3,5 W		



## CEILING MOUNTING WITH CORD SUSPENSION



### AX – VIEWING DISTANCE 30M

<b>SELF-CONTAINED LUMINAIRES WITH SELFCONTROL MODULE</b>							
LED, 1h, 230V AC	AXDC001SC	AXDC001SC-AZ	AXDC001SC-E	1 h	5,7 W	4,8V/2,0Ah NiMH	
LED, 3h, 230V AC	AXDC003SC	AXDC003SC-AZ	AXDC003SC-E	3 h	5,7 W	4,8V/2,0Ah NiMH	
LED, 8h, 230V AC	AXDC008SC	AXDC008SC-AZ	AXDC008SC-E	8 h	5,6 W	4,8V/2,0Ah NiMH	
<b>SELF-CONTAINED LUMINAIRES WITH WIRELESS PROFESSIONAL MODULE (SWITCHABLE)</b>							
LED, 1h, 230V AC	AXDC401WL	AXDC401WL-AZ	AXDC401WL-E	1 h	5,6 W	3,2V / 1,2 Ah LiFePO4	
LED, 3h, 230V AC	AXDC403WL	AXDC403WL-AZ	AXDC403WL-E	3 h	5,6 W	3,2V / 1,2 Ah LiFePO4	
<b>LUMINAIRES FOR CENTRAL BATTERY SYSTEMS AC/DC</b>							
LED, 230V AC/DC	AXDC009	AXDC009-AZ	AXDC009-E	CPS	3,3 W		
<b>LUMINAIRES FOR CENTRAL BATTERY SYSTEMS AC/DC INCL. MONITORING MODULE</b>							
LED, 230V AC/DC	AXDC009ML	AXDC009ML-AZ	AXDC009ML-E	CPS	4,5 W		

## RECESSED CEILING MOUNTING WITH PENDULUM



### AM – VIEWING DISTANCE 22M

<b>SELF-CONTAINED LUMINAIRES WITH SELFCONTROL MODULE</b>							
LED, 1h, 230V AC	AMCP001SC	AMCP001SC-AZ	AMCP001SC-E	1 h	4,7 W	4,8V/2,0Ah NiMH	
LED, 3h, 230V AC	AMCP003SC	AMCP003SC-AZ	AMCP003SC-E	3 h	4,7 W	4,8V/2,0Ah NiMH	
LED, 8h, 230V AC	AMCP008SC	AMCP008SC-AZ	AMCP008SC-E	8 h	4,6 W	4,8V/2,0Ah NiMH	
<b>SELF-CONTAINED LUMINAIRES WITH WIRELESS PROFESSIONAL MODULE (SWITCHABLE)</b>							
LED, 1h, 230V AC	AMCP401WL	AMCP401WL-AZ	AMCP401WL-E	1 h	4,7 W	3,2V / 1,2 Ah LiFePO4	
LED, 3h, 230V AC	AMCP403WL	AMCP403WL-AZ	AMCP403WL-E	3 h	4,7 W	3,2V / 1,2 Ah LiFePO4	
<b>LUMINAIRES FOR CENTRAL BATTERY SYSTEMS AC/DC</b>							
LED, 230V AC/DC	AMCP009	AMCP009-AZ	AMCP009-E	CPS	2,4 W		
<b>LUMINAIRES FOR CENTRAL BATTERY SYSTEMS AC/DC INCL. MONITORING MODULE</b>							
LED, 230V AC/DC	AMCP009ML	AMCP009ML-AZ	AMCP009ML-E	CPS	3,5 W		



## RECESSED CEILING MOUNTING WITH PENDULUM













### AX – VIEWING DISTANCE 30M

<b>SELF-CONTAINED LUMINAIRES WITH SELFCONTROL MODULE</b>							
LED, 1h, 230V AC	AXCP001SC	AXCP001SC-AZ	AXCP001SC-E	1 h	5,7 W	4,8V/2,0Ah NiMH	
LED, 3h, 230V AC	AXCP003SC	AXCP003SC-AZ	AXCP003SC-E	3 h	5,7 W	4,8V/2,0Ah NiMH	
LED, 8h, 230V AC	AXCP008SC	AXCP008SC-AZ	AXCP008SC-E	8 h	5,6 W	4,8V/2,0Ah NiMH	
<b>SELF-CONTAINED LUMINAIRES WITH WIRELESS PROFESSIONAL MODULE (SWITCHABLE)</b>							
LED, 1h, 230V AC	AXCP401WL	AXCP401WL-AZ	AXCP401WL-E	1 h	5,6 W	3,2V / 1,2 Ah LiFePO4	
LED, 3h, 230V AC	AXCP403WL	AXCP403WL-AZ	AXCP403WL-E	3 h	5,6 W	3,2V / 1,2 Ah LiFePO4	
<b>LUMINAIRES FOR CENTRAL BATTERY SYSTEMS AC/DC</b>							
LED, 230V AC/DC	AXCP009	AXCP009-AZ	AXCP009-E	CPS	3,3 W		
<b>LUMINAIRES FOR CENTRAL BATTERY SYSTEMS AC/DC INCL. MONITORING MODULE</b>							
LED, 230V AC/DC	AXCP009ML	AXCP009ML-AZ	AXCP009ML-E	CPS	4,5 W		

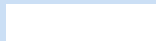
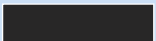
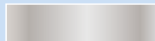
## CEILING MOUNTING WITH PENDULUM



### AM – VIEWING DISTANCE 22M

		   						
								
<b>SELF-CONTAINED LUMINAIRES WITH SELFCONTROL MODULE</b>								
LED, 1h, 230V AC	AMDP001SC	AMDP001SC-AZ	AMDP001SC-E	1 h	4,7 W	4,8V/2,0Ah NiMH		
LED, 3h, 230V AC	AMDP003SC	AMDP003SC-AZ	AMDP003SC-E	3 h	4,7 W	4,8V/2,0Ah NiMH		
LED, 8h, 230V AC	AMDP008SC	AMDP008SC-AZ	AMDP008SC-E	8 h	4,6 W	4,8V/2,0Ah NiMH		
<b>SELF-CONTAINED LUMINAIRES WITH WIRELESS PROFESSIONAL MODULE (SWITCHABLE)</b>								
LED, 1h, 230V AC	AMDP401WL	AMDP401WL-AZ	AMDP401WL-E	1 h	4,7 W	3,2V / 1,2 Ah LiFePO4		
LED, 3h, 230V AC	AMDP403WL	AMDP403WL-AZ	AMDP403WL-E	3 h	4,7 W	3,2V / 1,2 Ah LiFePO4		
<b>LUMINAIRES FOR CENTRAL BATTERY SYSTEMS AC/DC</b>								
LED, 230V AC/DC	AMDP009	AMDP009-AZ	AMDP009-E	CPS	2,4 W			
<b>LUMINAIRES FOR CENTRAL BATTERY SYSTEMS AC/DC INCL. MONITORING MODULE</b>								
LED, 230V AC/DC	AMDP009ML	AMDP009ML-AZ	AMDP009ML-E	CPS	3,5 W			



## CEILING MOUNTING WITH PENDULUM



### AX – VIEWING DISTANCE 30M

<b>SELF-CONTAINED LUMINAIRES WITH SELFCONTROL MODULE</b>							
LED, 1h, 230V AC	AXDP001SC	AXDP001SC-AZ	AXDP001SC-E	1 h	5,7 W	4,8V/2,0Ah NiMH	
LED, 3h, 230V AC	AXDP003SC	AXDP003SC-AZ	AXDP003SC-E	3 h	5,7 W	4,8V/2,0Ah NiMH	
LED, 8h, 230V AC	AXDP008SC	AXDP008SC-AZ	AXDP008SC-E	8 h	5,6 W	4,8V/2,0Ah NiMH	
<b>SELF-CONTAINED LUMINAIRES WITH WIRELESS PROFESSIONAL MODULE (SWITCHABLE)</b>							
LED, 1h, 230V AC	AXDP401WL	AXDP401WL-AZ	AXDP401WL-E	1 h	5,6 W	3,2V / 1,2 Ah LiFePO4	
LED, 3h, 230V AC	AXDP403WL	AXDP403WL-AZ	AXDP403WL-E	3 h	5,6 W	3,2V / 1,2 Ah LiFePO4	
<b>LUMINAIRES FOR CENTRAL BATTERY SYSTEMS AC/DC</b>							
LED, 230V AC/DC	AXDP009	AXDP009-AZ	AXDP009-E	CPS	3,3 W		
<b>LUMINAIRES FOR CENTRAL BATTERY SYSTEMS AC/DC INCL. MONITORING MODULE</b>							
LED, 230V AC/DC	AXDP009ML	AXDP009ML-AZ	AXDP009ML-E	CPS	4,5 W		

## RECESSED WALL MOUNTING WITH WALL BRACKET



### AM – VIEWING DISTANCE 22M

<b>SELF-CONTAINED LUMINAIRES WITH SELFCONTROL MODULE</b>							
LED, 1h, 230V AC	AMRA001SC	AMRA001SC-AZ	AMRA001SC-E	1 h	4,7 W	4,8V/2,0Ah NiMH	
LED, 3h, 230V AC	AMRA003SC	AMRA003SC-AZ	AMRA003SC-E	3 h	4,7 W	4,8V/2,0Ah NiMH	
LED, 8h, 230V AC	AMRA008SC	AMRA008SC-AZ	AMRA008SC-E	8 h	4,6 W	4,8V/2,0Ah NiMH	
<b>SELF-CONTAINED LUMINAIRES WITH WIRELESS PROFESSIONAL MODULE (SWITCHABLE)</b>							
LED, 8h, 230V AC	AMRA401WL	AMRA401WL-AZ	AMRA401WL-E	1 h	4,7 W	3,2V / 1,2 Ah LiFePO4	
LED, 3h, 230V AC	AMRA403WL	AMRA403WL-AZ	AMRA403WL-E	3 h	4,7 W	3,2V / 1,2 Ah LiFePO4	
<b>LUMINAIRES FOR CENTRAL BATTERY SYSTEMS AC/DC</b>							
LED, 230V AC/DC	AMRA009	AMRA009-AZ	AMRA009-E	CPS	2,4 W		
<b>LUMINAIRES FOR CENTRAL BATTERY SYSTEMS AC/DC INCL. MONITORING MODULE</b>							
LED, 230V AC/DC	AMRA009ML	AMRA009ML-AZ	AMRA009ML-E	CPS	3,5 W		





## RECESSED WALL MOUNTING WITH WALL BRACKET













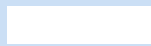
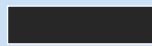

### AX – VIEWING DISTANCE 30M

<b>SELF-CONTAINED LUMINAIRES WITH SELFCONTROL MODULE</b>							
LED, 1h, 230V AC	AXRA001SC	AXRA001SC-AZ	AXRA001SC-E	1 h	5,7 W	4,8V/2,0Ah NiMH	
LED, 3h, 230V AC	AXRA003SC	AXRA003SC-AZ	AXRA003SC-E	3 h	5,7 W	4,8V/2,0Ah NiMH	
LED, 8h, 230V AC	AXRA008SC	AXRA008SC-AZ	AXRA008SC-E	8 h	5,6 W	4,8V/2,0Ah NiMH	
<b>SELF-CONTAINED LUMINAIRES WITH WIRELESS PROFESSIONAL MODULE (SWITCHABLE)</b>							
LED, 1h, 230V AC	AXRA401WL	AXRA401WL-AZ	AXRA401WL-E	1 h	5,6 W	3,2V / 1,2 Ah LiFePO4	
LED, 3h, 230V AC	AXRA403WL	AXRA403WL-AZ	AXRA403WL-E	3 h	5,6 W	3,2V / 1,2 Ah LiFePO4	
<b>LUMINAIRES FOR CENTRAL BATTERY SYSTEMS AC/DC</b>							
LED, 230V AC/DC	AXRA009	AXRA009-AZ	AXRA009-E	CPS	3,3 W		
<b>LUMINAIRES FOR CENTRAL BATTERY SYSTEMS AC/DC INCL. MONITORING MODULE</b>							
LED, 230V AC/DC	AXRA009ML	AXRA009ML-AZ	AXRA009ML-E	CPS	4,5 W		

## WALL MOUNTING WITH WALL BRACKET



### AM – VIEWING DISTANCE 22M

							
							
<b>SELF-CONTAINED LUMINAIRES WITH SELFCONTROL MODULE</b>							
LED, 1h, 230V AC	AMWA001SC	AMWA001SC-AZ	AMWA001SC-E	1 h	4,7 W	4,8V/2,0Ah NiMH	
LED, 3h, 230V AC	AMWA003SC	AMWA003SC-AZ	AMWA003SC-E	3 h	4,7 W	4,8V/2,0Ah NiMH	
LED, 8h, 230V AC	AMWA008SC	AMWA008SC-AZ	AMWA008SC-E	8 h	4,6 W	4,8V/2,0Ah NiMH	
<b>SELF-CONTAINED LUMINAIRES WITH WIRELESS PROFESSIONAL MODULE (SWITCHABLE)</b>							
LED, 1h, 230V AC	AMWA401WL	AMWA401WL-AZ	AMWA401WL-E	1 h	4,7 W	3,2V / 1,2 Ah LiFePO4	
LED, 3h, 230V AC	AMWA403WL	AMWA403WL-AZ	AMWA403WL-E	3 h	4,7 W	3,2V / 1,2 Ah LiFePO4	
<b>LUMINAIRES FOR CENTRAL BATTERY SYSTEMS AC/DC</b>							
LED, 230V AC/DC	AMWA009	AMWA009-AZ	AMWA009-E	CPS	2,4 W		
<b>LUMINAIRES FOR CENTRAL BATTERY SYSTEMS AC/DC INCL. MONITORING MODULE</b>							
LED, 230V AC/DC	AMWA009ML	AMWA009ML-AZ	AMWA009ML-E	CPS	3,5 W		



## WALL MOUNTING WITH WALL BRACKET













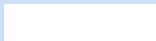
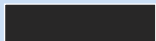

### AX – VIEWING DISTANCE 30M

<b>SELF-CONTAINED LUMINAIRES WITH SELFCONTROL MODULE</b>								
LED, 1h, 230V AC	AXWA001SC	AXWA001SC-AZ	AXWA001SC-E	1 h	5,7 W	4,8V/2,0Ah NiMH		
LED, 3h, 230V AC	AXWA003SC	AXWA003SC-AZ	AXWA003SC-E	3 h	5,7 W	4,8V/2,0Ah NiMH		
LED, 8h, 230V AC	AXWA008SC	AXWA008SC-AZ	AXWA008SC-E	8 h	5,6 W	4,8V/2,0Ah NiMH		
<b>SELF-CONTAINED LUMINAIRES WITH WIRELESS PROFESSIONAL MODULE (SWITCHABLE)</b>								
LED, 1h, 230V AC	AXWA401WL	AXWA401WL-AZ	AXWA401WL-E	1 h	5,6 W	3,2V / 1,2 Ah LiFePO4		
LED, 3h, 230V AC	AXWA403WL	AXWA403WL-AZ	AXWA403WL-E	3 h	5,6 W	3,2V / 1,2 Ah LiFePO4		
<b>LUMINAIRES FOR CENTRAL BATTERY SYSTEMS AC/DC</b>								
LED, 230V AC/DC	AXWA009	AXWA009-AZ	AXWA009-E	CPS	3,3 W			
<b>LUMINAIRES FOR CENTRAL BATTERY SYSTEMS AC/DC INCL. MONITORING MODULE</b>								
LED, 230V AC/DC	AXWA009ML	AXWA009ML-AZ	AXWA009ML-E	CPS	4,5 W			

## RECESSED CEILING MOUNTING - CIRCULAR CUT-OUT



### AM – VIEWING DISTANCE 22M

		    					
							
<b>SELF-CONTAINED LUMINAIRES WITH SELFCONTROL MODULE</b>							
LED, 1h, 230V AC	AME001SC	AME001SC-AZ	AME001SC-E	1 h	4,7 W	4,8V/2,0Ah NiMH	
LED, 3h, 230V AC	AME003SC	AME003SC-AZ	AME003SC-E	3 h	4,7 W	4,8V/2,0Ah NiMH	
LED, 8h, 230V AC	AME008SC	AME008SC-AZ	AME008SC-E	8 h	4,6 W	4,8V/2,0Ah NiMH	
<b>SELF-CONTAINED LUMINAIRES WITH WIRELESS PROFESSIONAL MODULE (SWITCHABLE)</b>							
LED, 1h, 230V AC	AME401WL	AME401WL-AZ	AME401WL-E	1 h	4,7 W	3,2V / 1,2 Ah LiFePO4	
LED, 3h, 230V AC	AME403WL	AME403WL-AZ	AME403WL-E	3 h	4,7 W	3,2V / 1,2 Ah LiFePO4	
<b>LUMINAIRES FOR CENTRAL BATTERY SYSTEMS AC/DC</b>							
LED, 230V AC/DC	AME009	AME009-AZ	AME009-E	CPS	2,4 W		
<b>LUMINAIRES FOR CENTRAL BATTERY SYSTEMS AC/DC INCL. MONITORING MODULE</b>							
LED, 230V AC/DC	AME009ML	AME009ML-AZ	AME009ML-E	CPS	3,2 W		



## RECESSED CEILING MOUNTING - CIRCULAR CUT-OUT



### AX – VIEWING DISTANCE 30M

<b>SELF-CONTAINED LUMINAIRES WITH SELFCONTROL MODULE</b>						
LED, 1h, 230V AC	AXE001SC	AXE001SC-AZ	AXE001SC-E	1 h	5,7 W	4,8V/2,0Ah NiMH
LED, 3h, 230V AC	AXE003SC	AXE003SC-AZ	AXE003SC-E	3 h	5,7 W	4,8V/2,0Ah NiMH
LED, 8h, 230V AC	AXE008SC	AXE008SC-AZ	AXE008SC-E	8 h	5,6 W	4,8V/2,0Ah NiMH
<b>SELF-CONTAINED LUMINAIRES WITH WIRELESS PROFESSIONAL MODULE (SWITCHABLE)</b>						
LED, 1h, 230V AC	AXE401WL	AXE401WL-AZ	AXE401WL-E	1 h	5,6 W	3,2V / 1,2 Ah LiFePO4
LED, 3h, 230V AC	AXE403WL	AXE403WL-AZ	AXE403WL-E	3 h	5,6 W	3,2V / 1,2 Ah LiFePO4
<b>LUMINAIRES FOR CENTRAL BATTERY SYSTEMS AC/DC</b>						
LED, 230V AC/DC	AXE009	AXE009-AZ	AXE009-E	CPS	3,3 W	
<b>LUMINAIRES FOR CENTRAL BATTERY SYSTEMS AC/DC INCL. MONITORING MODULE</b>						
LED, 230V AC/DC	AXE009ML	AXE009ML-AZ	AXE009ML-E	CPS	4,5 W	

## RECESSED CEILING MOUNTING WITH CORD SUSPENSION - CIRCULAR CUT-OUT



### AM – VIEWING DISTANCE 22M

<b>SELF-CONTAINED LUMINAIRES WITH SELFCONTROL MODULE</b>							
LED, 1h, 230V AC	AMEC001SC	AMEC001SC-AZ	AMEC001SC-E	1 h	4,7 W	4,8V/2,0Ah NiMH	
LED, 3h, 230V AC	AMEC003SC	AMEC003SC-AZ	AMEC003SC-E	3 h	4,7 W	4,8V/2,0Ah NiMH	
LED, 8h, 230V AC	AMEC008SC	AMEC008SC-AZ	AMEC008SC-E	8 h	4,6 W	4,8V/2,0Ah NiMH	
<b>SELF-CONTAINED LUMINAIRES WITH WIRELESS PROFESSIONAL MODULE (SWITCHABLE)</b>							
LED, 1h, 230V AC	AMEC401WL	AMEC401WL-AZ	AMEC401WL-E	1 h	4,7 W	3,2V / 1,2 Ah LiFePO4	
LED, 3h, 230V AC	AMEC403WL	AMEC403WL-AZ	AMEC403WL-E	3 h	4,7 W	3,2V / 1,2 Ah LiFePO4	
<b>LUMINAIRES FOR CENTRAL BATTERY SYSTEMS AC/DC</b>							
LED, 230V AC/DC	AMEC009	AMEC009-AZ	AMEC009-E	CPS	2,4 W		
<b>LUMINAIRES FOR CENTRAL BATTERY SYSTEMS AC/DC INCL. MONITORING MODULE</b>							
LED, 230V AC/DC	AMEC009ML	AMEC009ML-AZ	AMEC009ML-E	CPS	3,5 W		



## RECESSED CEILING MOUNTING WITH CORD SUSPENSION - CIRCULAR CUT-OUT



### AX – VIEWING DISTANCE 30M

<b>SELF-CONTAINED LUMINAIRES WITH SELFCONTROL MODULE</b>							
LED, 1h, 230V AC	AXEC001SC	AXEC001SC-AZ	AXEC001SC-E	1 h	5,7 W	4,8V/2,0Ah NiMH	
LED, 3h, 230V AC	AXEC003SC	AXEC003SC-AZ	AXEC003SC-E	3 h	5,7 W	4,8V/2,0Ah NiMH	
LED, 8h, 230V AC	AXEC008SC	AXEC008SC-AZ	AXEC008SC-E	8 h	5,6 W	4,8V/2,0Ah NiMH	
<b>SELF-CONTAINED LUMINAIRES WITH WIRELESS PROFESSIONAL MODULE (SWITCHABLE)</b>							
LED, 1h, 230V AC	AXEC401WL	AXEC401WL-AZ	AXEC401WL-E	1 h	5,6 W	3,2V / 1,2 Ah LiFePO4	
LED, 3h, 230V AC	AXEC403WL	AXEC403WL-AZ		3 h	5,6 W	3,2V / 1,2 Ah LiFePO4	
<b>LUMINAIRES FOR CENTRAL BATTERY SYSTEMS AC/DC</b>							
LED, 230V AC/DC	AXEC009	AXEC009-AZ	AXEC009-E	CPS	3,3 W		
<b>LUMINAIRES FOR CENTRAL BATTERY SYSTEMS AC/DC INCL. MONITORING MODULE</b>							
LED, 230V AC/DC	AXEC009ML	AXEC009ML-AZ	AXEC009ML-E	CPS	4,5 W		

## RECESSED CEILING MOUNTING WITH PENDULUM - CIRCULAR CUT-OUT



### AM – VIEWING DISTANCE 22M

<b>SELF-CONTAINED LUMINAIRES WITH SELFCONTROL MODULE</b>							
LED, 1h, 230V AC	AMEP001SC	AMEP001SC-AZ	AMEP001SC-E	1 h	4,7 W	4,8V/2,0Ah NiMH	
LED, 3h, 230V AC	AMEP003SC	AMEP003SC-AZ	AMEP003SC-E	3 h	4,7 W	4,8V/2,0Ah NiMH	
LED, 8h, 230V AC	AMEP008SC	AMEP008SC-AZ	AMEP008SC-E	8 h	4,6 W	4,8V/2,0Ah NiMH	
<b>SELF-CONTAINED LUMINAIRES WITH WIRELESS PROFESSIONAL MODULE (SWITCHABLE)</b>							
LED, 1h, 230V AC	AMEP401WL	AMEP401WL-AZ	AMEP401WL-E	1 h	4,7 W	3,2V / 1,2 Ah LiFePO4	
LED, 3h, 230V AC	AMEP403WL	AMEP403WL-AZ	AMEP403WL-E	3 h	4,7 W	3,2V / 1,2 Ah LiFePO4	
<b>LUMINAIRES FOR CENTRAL BATTERY SYSTEMS AC/DC</b>							
LED, 230V AC/DC	AMEP009	AMEP009-AZ	AMEP009-E	CPS	2,4 W		
<b>LUMINAIRES FOR CENTRAL BATTERY SYSTEMS AC/DC INCL. MONITORING MODULE</b>							
LED, 230V AC/DC	AMEP009ML	AMEP009ML-AZ	AMEP009ML-E	CPS	3,5 W		





## RECESSED CEILING MOUNTING WITH PENDULUM - CIRCULAR CUT-OUT











### AX – VIEWING DISTANCE 30M

<b>SELF-CONTAINED LUMINAIRES WITH SELFCONTROL MODULE</b>							
LED, 1h, 230V AC	AXEP001SC	AXEP001SC-AZ	AXEP001SC-E	1 h	5,7 W	4,8V/2,0Ah NiMH	
LED, 3h, 230V AC	AXEP003SC	AXEP003SC-AZ	AXEP003SC-E	3 h	5,7 W	4,8V/2,0Ah NiMH	
LED, 8h, 230V AC	AXEP008SC	AXEP008SC-AZ	AXEP008SC-E	8 h	5,6 W	4,8V/2,0Ah NiMH	
<b>SELF-CONTAINED LUMINAIRES WITH WIRELESS PROFESSIONAL MODULE (SWITCHABLE)</b>							
LED, 1h, 230V AC	AXEP401WL	AXEP401WL-AZ	AXEP401WL-E	1 h	5,6 W	3,2V / 1,2 Ah LiFePO4	
LED, 3h, 230V AC	AXEP403WL	AXEP403WL-AZ	AXEP403WL-E	3 h	5,6 W	3,2V / 1,2 Ah LiFePO4	
<b>LUMINAIRES FOR CENTRAL BATTERY SYSTEMS AC/DC</b>							
LED, 230V AC/DC	AXEP009	AXEP009-AZ	AXEP009-E	CPS	3,3 W		
<b>LUMINAIRES FOR CENTRAL BATTERY SYSTEMS AC/DC INCL. MONITORING MODULE</b>							
LED, 230V AC/DC	AXEP009ML	AXEP009ML-AZ	AXEP009ML-E	CPS	4,5 W		







## CEILING MOUNTED EXIT SIGN WITH SAFETY LIGHT





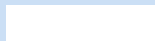
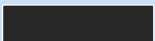

### AM – VIEWING DISTANCE 22M

						
						
LUMINAIRES FOR CENTRAL BATTERY SYSTEMS AC/DC INKL. ÜBERWACHUNGSBAUSTEIN						
LED, 230V AC/DC	AMDT009ML	AMDT009ML-AZ	AMDT009ML-E	CPS	4,2 W	

### AX – VIEWING DISTANCE 30M

						
						
LUMINAIRES FOR CENTRAL BATTERY SYSTEMS AC/DC INKL. ÜBERWACHUNGSBAUSTEIN						
LED, 230V AC/DC	AXDT009ML	AXDT009ML-AZ	AXDT009ML-E	CPS	4,9 W	

Distance table AMDT / AXDT for plane emergency routes (additional distance tables on our website)

Mounting height (m)					
2.50	3.45	10.49	6.98	3.81	1.60
3.00	0.00	7.44	3.04	4.16	1.69
3.50	0.00	6.72	2.43	3.94	0.76
4.00	0.00	0.95	0.95	0.95	0.43



# AM / AX CT

## RECESSED CEILING MOUNTED EXIT SIGN WITH SAFETY LIGHT



### AM – VIEWING DISTANCE 22M

LUMINAIRES FOR CENTRAL BATTERY SYSTEMS AC/DC INKL. ÜBERWACHUNGSBAUSTEIN						
LED, 230V AC/DC	AMCT009ML	AMCT009ML-AZ	AMCT009ML-E	CPS	4,2 W	

### AX – VIEWING DISTANCE 30M

LUMINAIRES FOR CENTRAL BATTERY SYSTEMS AC/DC INKL. ÜBERWACHUNGSBAUSTEIN						
LED, 230V AC/DC	AXCT009ML	AXCT009ML-AZ	AXCT009ML-E	CPS	4,9 W	

Distance table AMCT / AXCT for plane emergency routes (additional distance tables on our website)

Mounting height (m)					
2.50	3.45	10.49	6.98	3.81	1.60
3.00	0.00	7.44	3.04	4.16	1.69
3.50	0.00	6.72	2.43	3.94	0.76
4.00	0.00	0.95	0.95	0.95	0.43

## WALL MOUNTING EXIT SIGN WITH ADDITIONAL SAFETY LIGHT

**2in1**  
Safety light and exit sign in one



### AM – VIEWING DISTANCE 22M

LUMINAIRES FOR CENTRAL BATTERY SYSTEMS AC/DC INKL. ÜBERWACHUNGSBAUSTEIN						
LED, 230V AC/DC	AMWT009ML	AMWT009ML-AZ	AMWT009ML-E	CPS	3,5 W	

### AX – VIEWING DISTANCE 30M

LUMINAIRES FOR CENTRAL BATTERY SYSTEMS AC/DC INKL. ÜBERWACHUNGSBAUSTEIN						
LED, 230V AC/DC	AXWT009ML	AXWT009ML-AZ	AXWT009ML-E	CPS	4,5 W	

Distance table AMWT / AXWT for plane emergency routes (additional distance tables on our website)

Mounting height (m)					
2.50	0.89	3.34	3.37	5.28	2.19
3.00	1.05	3.72	3.74	5.73	2.37
3.50	1.19	4.03	4.04	6.15	2.50
4.00	1.33	4.25	4.26	6.50	2.61



## DIMENSIONS

### WALL MOUNTING

Dimensions AM Wall mounting

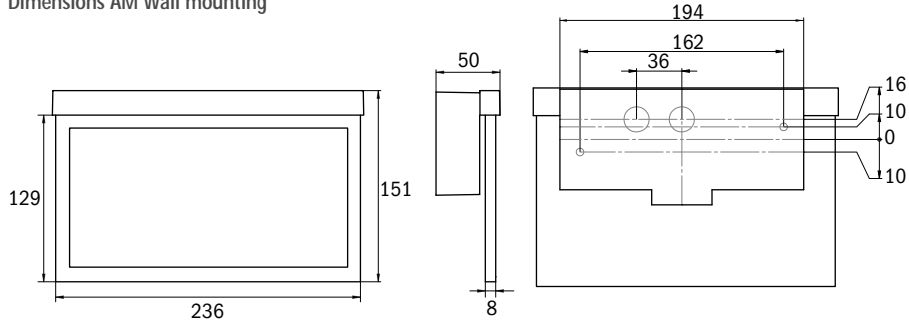

Dimensions AX Wall mounting

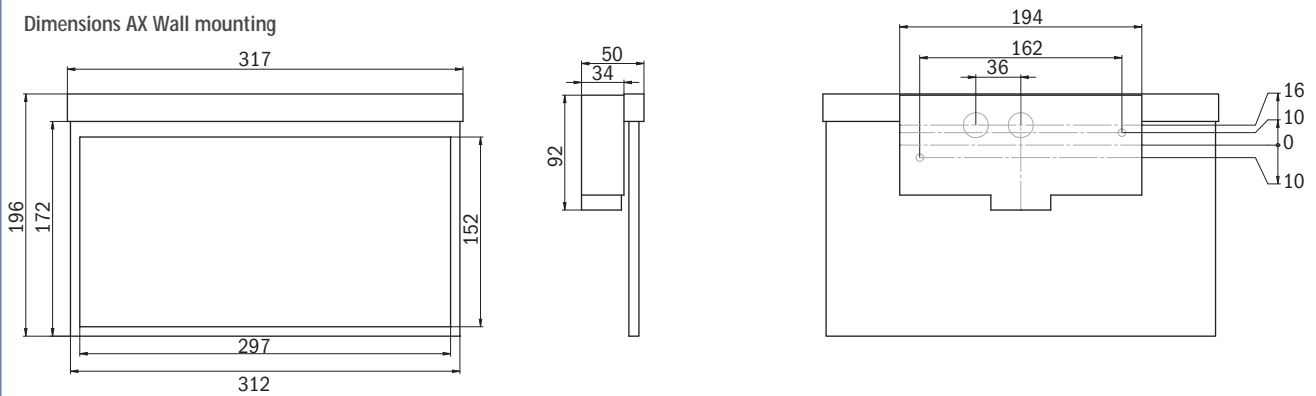

### CEILING MOUNTING

Dimensions AM CEILING MOUNTING

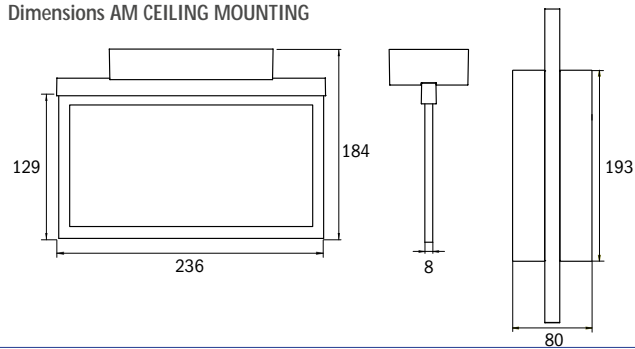

Dimensions AX CEILING MOUNTING

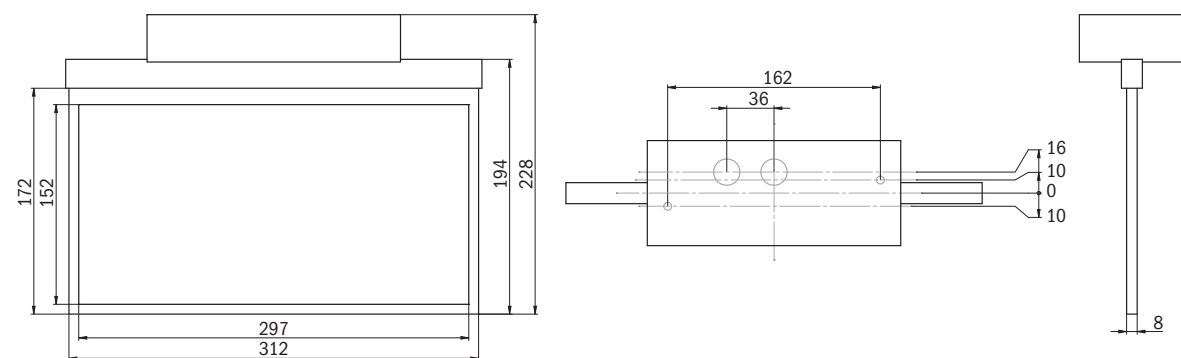

## RECESSED MOUNTING

Cut-out for recessed mounting AMC/AXC

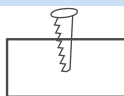

Cut-out for recessed mounting AME/AXE

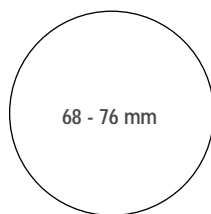

## RECESSED WALL MOUNTING

Dimensions AMR Recessed wall mounting

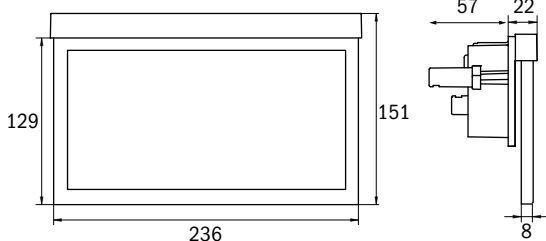

Dimensions AXR Recessed wall mounting

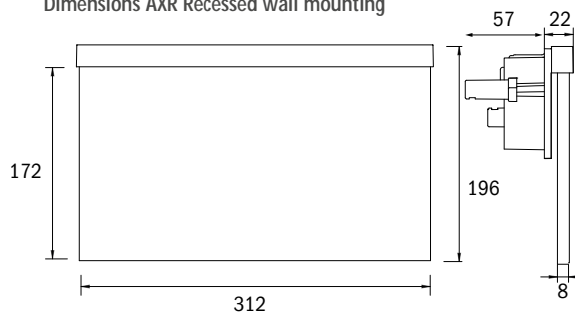

## RECESSED CEILING MOUNTING

Dimensions AM Recessed ceiling mounting AMC

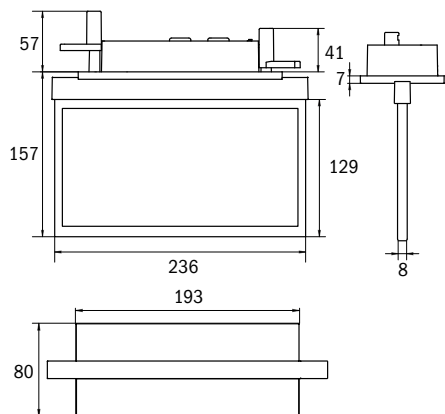

Dimensions AX Recessed ceiling mounting AXC

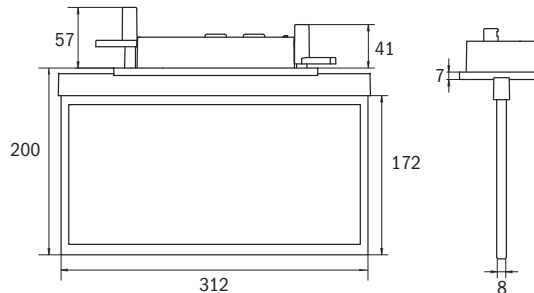

## ACCESSORIES



Cord suspension:  
Standard length 1500mm  
(reducible)



Pendulum:  
Standard length 500mm  
(reducible)



Pendulum ball joint  
AM-X-PKG-WS (white),  
AM-X-PKG-AZ (anthracite),  
AM-X-PKG-E (stainless steel  
look)











Surface mounting adapter  
for lateral cable feed  
AM-X-APA (white),  
AM-X-APA-AZ (anthracite),  
AM-X-APA-E (stainless steel  
look)

CEILING MOUNTING

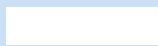
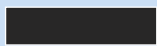

AGD – VIEWING DISTANCE 50M

								
								
<b>SELF-CONTAINED LUMINAIRES WITH SELFCONTROL MODULE</b>								
LED, 1h, 230V AC	AGD001SC	AGD001SC-AZ	AGD001SC-E	1 h	5,8 W	4,8V/2,0Ah NiMH		
LED, 3h, 230V AC	AGD003SC	AGD003SC-AZ	AGD003SC-E	3 h	5,8 W	4,8V/2,0Ah NiMH		
<b>LUMINAIRES FOR CENTRAL BATTERY SYSTEMS AC/DC</b>								
LED, 230V AC/DC	AGD009	AGD009-AZ	AGD009-E	CPS	5,2 W			
<b>LUMINAIRES FOR CENTRAL BATTERY SYSTEMS AC/DC INCL. MONITORING MODULE</b>								
LED, 230V AC/DC	AGD009ML	AGD009ML-AZ	AGD009ML-E	CPS	6,1 W			





## RECESSED CEILING MOUNTING



### AGC – VIEWING DISTANCE 50M

<b>SELF-CONTAINED LUMINAIRES WITH SELFCONTROL MODULE</b>							
LED, 1h, 230V AC	AGC001SC	AGC001SC-AZ	AGC001SC-E	1 h	5,8 W	4,8V/2,0Ah NiMH	
LED, 3h, 230V AC	AGC003SC	AGC003SC-AZ	AGC003SC-E	3 h	5,8 W	4,8V/2,0Ah NiMH	
<b>LUMINAIRES FOR CENTRAL BATTERY SYSTEMS AC/DC</b>							
LED, 230V AC/DC	AGC009	AGC009-AZ	AGC009-E	CPS	5,2 W		
<b>LUMINAIRES FOR CENTRAL BATTERY SYSTEMS AC/DC INCL. MONITORING MODULE</b>							
LED, 230V AC/DC	AGC009ML	AGC009ML-AZ	AGC009ML-E	CPS	6,1 W		

CEILING MOUNTING WITH CORD SUSPENSION



AGDC – VIEWING DISTANCE 50M

<b>SELF-CONTAINED LUMINAIRES WITH SELFCONTROL MODULE</b>							
LED, 1h, 230V AC	AGDC001SC	AGDC001SC-AZ	AGDC001SC-E	1 h	5,8 W	4,8V/2,0Ah NiMH	
LED, 3h, 230V AC	AGDC003SC	AGDC003SC-AZ	AGDC003SC-E	3 h	5,8 W	4,8V/2,0Ah NiMH	
<b>LUMINAIRES FOR CENTRAL BATTERY SYSTEMS AC/DC</b>							
LED, 230V AC/DC	AGDC009	AGDC009-AZ	AGDC009-E	CPS	5,2 W		
<b>LUMINAIRES FOR CENTRAL BATTERY SYSTEMS AC/DC INCL. MONITORING MODULE</b>							
LED, 230V AC/DC	AGDC009ML	AGDC009ML-AZ	AGDC009ML-E	CPS	6,1 W		



## RECESSED CEILING MOUNTING WITH CORD SUSPENSION



### AGCC – VIEWING DISTANCE 50M

SELF-CONTAINED LUMINAIRES WITH SELFCONTROL MODULE							
LED, 1h, 230V AC	AGCC001SC	AGCC001SC-AZ	AGCC001SC-E	1 h	5,8 W	4,8V/2,0Ah NiMH	
LED, 3h, 230V AC	AGCC003SC	AGCC003SC-AZ	AGCC003SC-E	3 h	5,8 W	4,8V/2,0Ah NiMH	
LUMINAIRES FOR CENTRAL BATTERY SYSTEMS AC/DC							
LED, 230V AC/DC	AGCC009	AGCC009-AZ	AGCC009-E	CPS	5,2 W		
LUMINAIRES FOR CENTRAL BATTERY SYSTEMS AC/DC INCL. MONITORING MODULE							
LED, 230V AC/DC	AGCC009ML	AGCC009ML-AZ	AGCC009ML-E	CPS	6,1 W		

## WALL MOUNTING



## AGW – VIEWING DISTANCE 50M

<b>SELF-CONTAINED LUMINAIRES WITH SELFCONTROL MODULE</b>							
LED, 1h, 230V AC	AGW001SC	AGW001SC-AZ	AGW001SC-E	1 h	5,8 W	4,8V/2,0Ah NiMH	
LED, 3h, 230V AC	AGW003SC	AGW003SC-AZ	AGW003SC-E	3 h	5,8 W	4,8V/2,0Ah NiMH	
<b>LUMINAIRES FOR CENTRAL BATTERY SYSTEMS AC/DC</b>							
LED, 230V AC/DC	AGW009	AGW009-AZ	AGW009-E	CPS	5,2 W		
<b>LUMINAIRES FOR CENTRAL BATTERY SYSTEMS AC/DC INCL. MONITORING MODULE</b>							
LED, 230V AC/DC	AGW009ML	AGW009ML-AZ	AGW009ML-E	CPS	6,1 W		



## RECESSED WALL MOUNTING



### AGR – VIEWING DISTANCE 50M

<b>SELF-CONTAINED LUMINAIRES WITH SELFCONTROL MODULE</b>							
LED, 1h, 230V AC	AGR001SC	AGR001SC-AZ	AGR001SC-E	1 h	5,8 W	4,8V/2,0Ah NiMH	
LED, 3h, 230V AC	AGR003SC	AGR003SC-AZ	AGR003SC-E	3 h	5,8 W	4,8V/2,0Ah NiMH	
<b>LUMINAIRES FOR CENTRAL BATTERY SYSTEMS AC/DC</b>							
LED, 230V AC/DC	AGR009	AGR009-AZ	AGR009-E	CPS	5,2 W		
<b>LUMINAIRES FOR CENTRAL BATTERY SYSTEMS AC/DC INCL. MONITORING MODULE</b>							
LED, 230V AC/DC	AGR009ML	AGR009ML-AZ	AGR009ML-E	CPS	6,1 W		

## DIMENSIONS

### WALL MOUNTING

Dimensions AGW Wall mounting

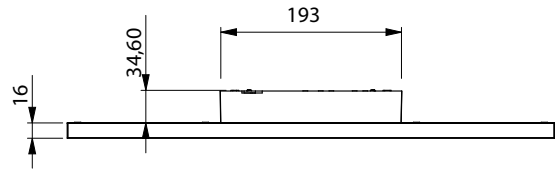
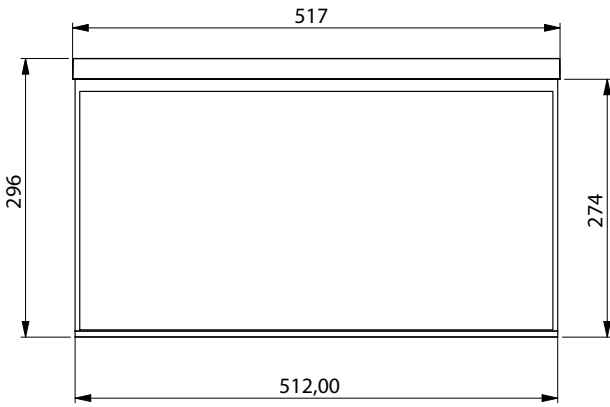

### CEILING MOUNTING

Dimensions AGD / AGDC CEILING MOUNTING

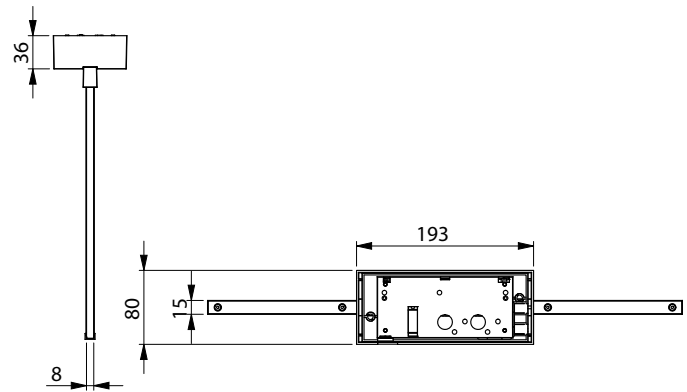
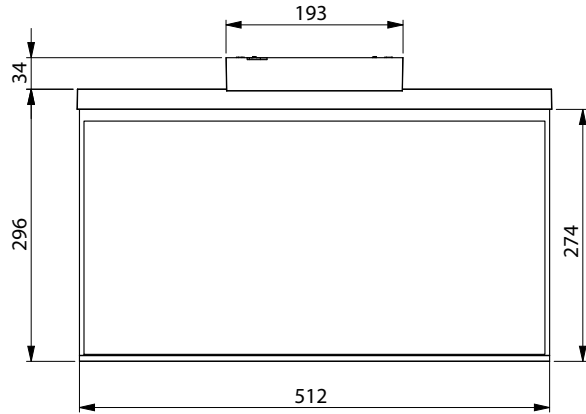

## RECESSED MOUNTING

Cut-out for recessed mounting AGC / AGCC

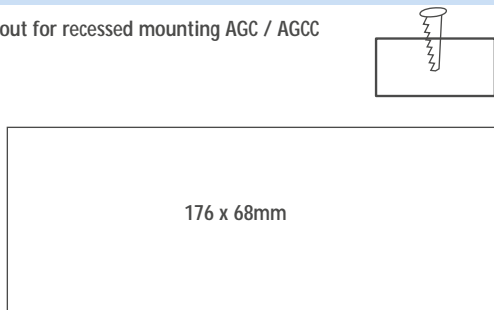

## RECESSED WALL MOUNTING

Dimensions AGR Recessed wall mounting

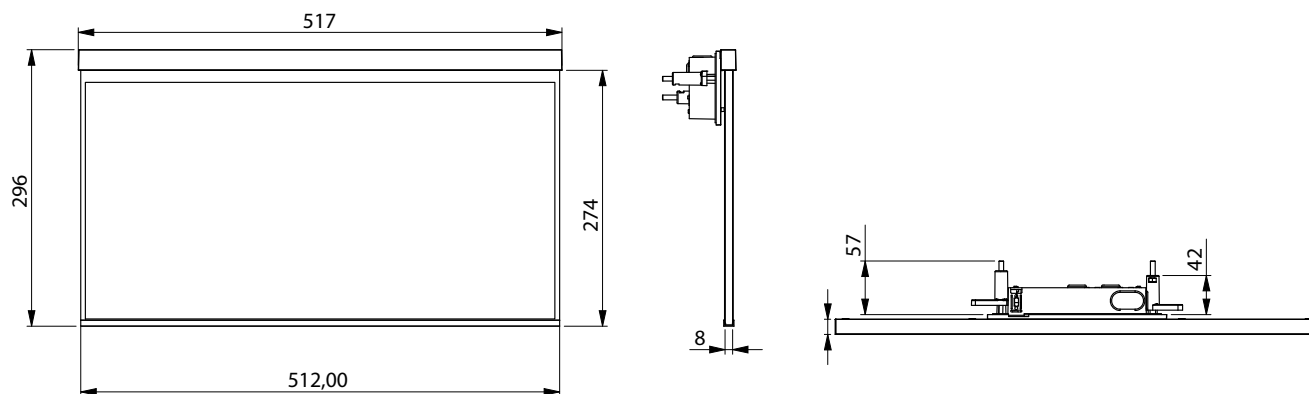

## RECESSED CEILING MOUNTING

Dimensions AGC / AGCC Recessed ceiling mounting

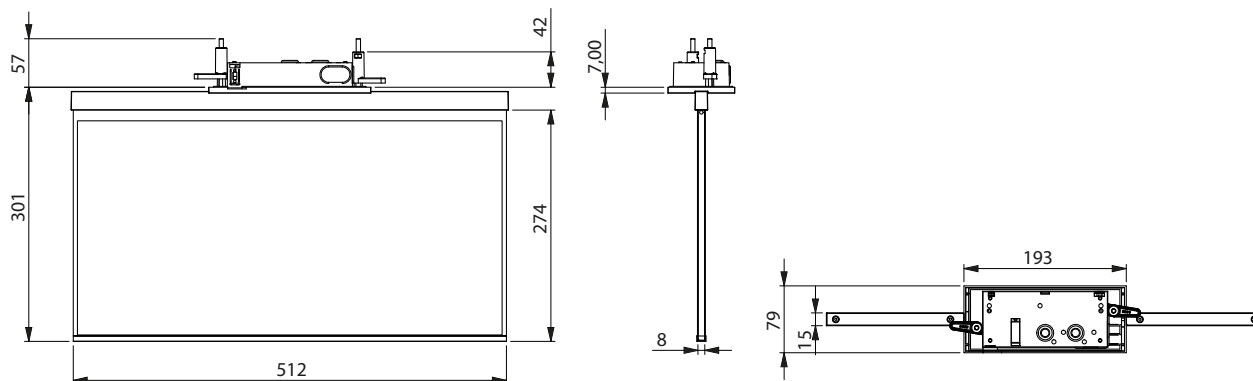



 **MMW / MMD**  
METAL HOUSING LUMINAIRES





## FACTS

- Zinc die-cast housing
- 22m Viewing distance
- Additional safety light as option (DUO-LED)
- Complete set of pictographs (ISO 7010)
- IP40
- LED Illuminant
- Wall or ceiling mounting
- -5° to +40°C















The advantages of the LED combined with a compact shape come together to a modern design. The high quality slim body is made from zinc-aluminium die-cast. You get planning security with variable use of pictographs who are changeable without tools on site.

LED escape route luminaire in accordance with DIN EN 60598-1, EN 60598-2-22, EN ISO 7010 and DIN EN 1838.

Optional with DUO-LED for additional light output downwards.



## METAL HOUSING LUMINAIRES WITH OPTIONAL DUO-TECHNOLOGY

						
<b>SELF-CONTAINED LUMINAIRES WITH SELFCONTROL MODULE</b>						
LED, 1h, 230V AC	MMD001SC *		1 h	7,4 W	4,8V/2,0Ah NiMH	
LED, 1h, 230V AC		MMW001SC *	1 h	4,2 W	4,8V/2,0Ah NiMH	
LED, 3h, 230V AC		MMW003SC *	3 h	4,2 W	4,8V/2,0Ah NiMH	
LED, 3h, 230V AC	MMD003SC *		3 h	7,4 W	4,8V/2,0Ah NiMH	
LED, 8h, 230V AC		MMW008SC *	8 h	4,2 W	4,8V/2,0Ah NiMH	
<b>LUMINAIRES FOR CENTRAL BATTERY SYSTEMS AC/DC</b>						
LED, 230V AC/DC	MMD009 *		CPS	3,9 W		
LED, 230V AC/DC		MMW009 *	CPS	2,5 W		
<b>LUMINAIRES FOR CENTRAL BATTERY SYSTEMS AC/DC INCL. MONITORING MODULE</b>						
DUO-LED, 230V AC/DC	MMDT009ML *		CPS	5,1		
DUO-LED, 230V AC/DC		MMWT009ML *	CPS	3,9 W		
LED, 230V AC/DC		MMW009ML *	CPS	3,9		
LED, 230V AC/DC	MMD009ML *		CPS	5,2 W		

\*) Standard: white (RAL 9003) | -AZ: anthracite (RAL 7016)

### WALL MOUNTING

Dimensions MMW

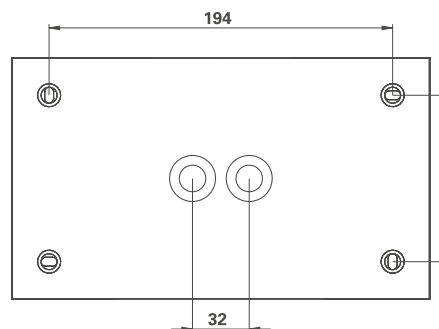
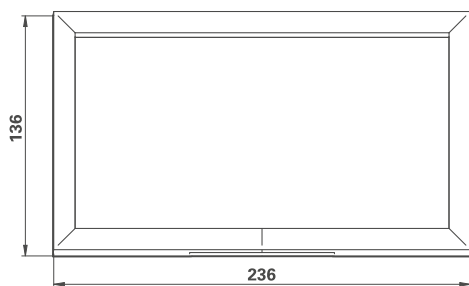

### CEILING MOUNTING

Dimensions MMD

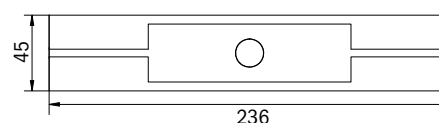
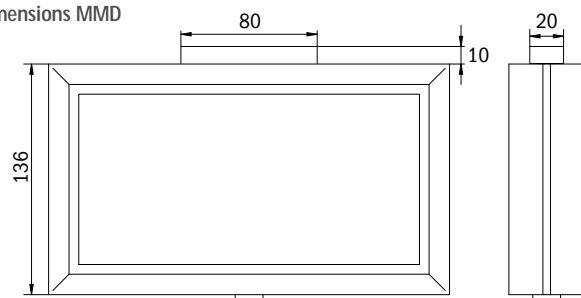

All dimensions in mm



**2in1**  
**Safety light and exit sign in one**



Distance table MMDT 009ML (with lens for corridor lighting) for plane emergency routes (additional distance tables on our website)

Mounting height (m)					
2.00	4.01	9.02	6.27	3.28	1.41
2.50	4.56	10.52	6.99	3.75	1.56
3.00	3.26	10.12	5.91	4.11	1.61
3.50	3.48	10.93	6.40	4.41	1.48
4.00	3.61	8.99	6.78	4.55	1.24

Distance table MMWT 009ML (with circular beam lens) for plane emergency routes (additional distance tables on our website)

Mounting height (m)					
2.00	1.96	4.87	4.80	4.73	1.91
2.50	2.16	5.31	5.23	5.14	2.09
3.00	2.32	5.72	5.64	5.56	2.26
3.50	2.44	6.08	5.99	5.89	2.37
4.00	2.52	6.42	6.34	6.25	2.47

## ACCESSORIES

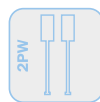
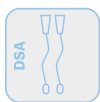

When mounting with cord suspension or pendulum the protection class is reduced to IP20.

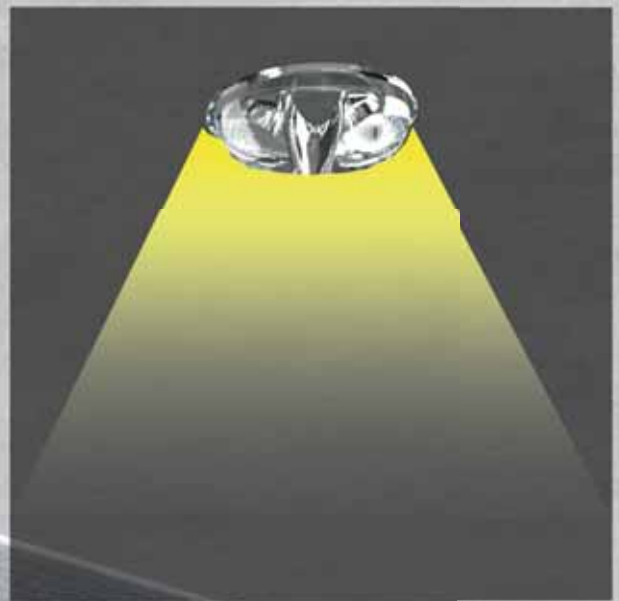
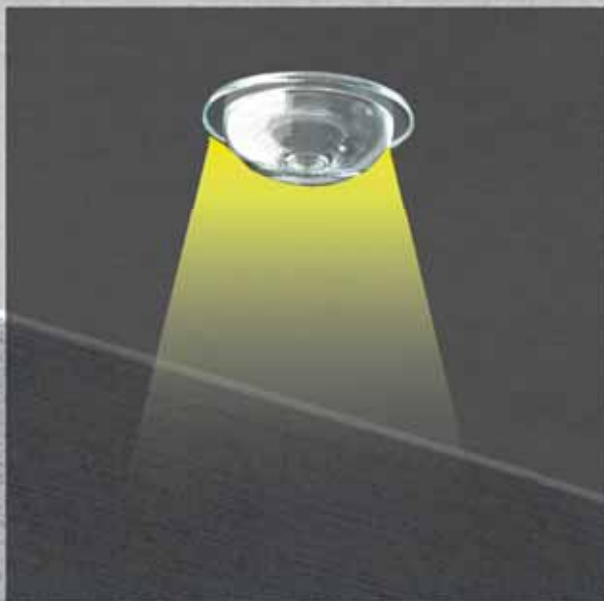

 **E-Series**  
EMERGENCY ROUTE LIGHTING



## FACTS

- Zinc die-cast housing
- IP20
- LED Illuminant
- Pluggable corridor or round lens for full flexibility at the installation site
- Ceiling or recessed mounting
- -5° to +40°C

The discreet downlight meets DIN EN 60598-1, DIN EN 60598-22 and DIN EN 1838. Made of zinc die-cast it fits unobtrusively on the ceiling. Besides normal recessed ceiling mounting it can also be mounted in conventional fire protection boxes. The status LED integrated within the lens does not interrupt the harmony of the decent housing. Optimal light distribution and lighting of escape and rescue routes is achieved by use of cluster lenses and powerful ERT LED technology. The EE emergency light is available with round (EERx) or square (EEQx) cover.

The fourth letter marks the type of lense used in the luminaire:

### EERR / EEQR

The radiate beam of the EERR / EEQR illuminates the escape and rescue route for ceiling heights up to 4m most effective at intersections of two corridors.

### EERF / EEQF

The EERF / EEQF has a lens to focus the light into two main directions. This corridor lights is particularly effective for normal ceiling heights up to 4m and enables luminaire spacing of about 18m in the escape route.

### EERS / EEQS

The spot lens of the EERS / EEQS ensures an even distribution of light in all directions, even with ceiling heights over 4m.















### EERL / EEQL

The innovative integrated lens socket with quick-mounting device enables flexible use of different lens types depending on the application. Round and corridor lenses are already included with every luminaire.



# » E-Series

## EMERGENCY ROUTE LIGHTING

						
<b>SELF-CONTAINED LUMINAIRES WITH SELFCONTROL MODULE</b>						
System lens (circular/corridor)	EEQL031SC *	EERL031SC **	1 h	5,9 W - 470 lm	4,8V/2,0Ah NiMH	
System lens (circular/corridor)	EEQL033SC *	EERL033SC **	3 h	5,9 W - 235 lm	4,8V/2,0Ah NiMH	
System lens (circular/corridor)	EEQL038SC *	EERL038SC **	8 h	7 W - 210 lm	9,6V/2,0Ah NiMH	
<b>SELF-CONTAINED LUMINAIRES WITH WIRELESS PROFESSIONAL MODULE (SWITCHABLE)</b>						
Corridor lighting	EEQF021WL *	EERF021WL **	1 h	5,6 W - 140 lm	4,8V/2,0Ah NiMH	
Circular beam	EEQR021WL *	EERR021WL **	1 h	5,6 W - 140 lm	4,8V/2,0Ah NiMH	
Spot	EEQS021WL *	EERS021WL **	1 h	5,6 W - 140 lm	4,8V/2,0Ah NiMH	
Corridor lighting	EEQF023WL *	EERF023WL **	3 h	5,6 W - 140 lm	4,8V/2,0Ah NiMH	
Circular beam	EEQR023WL *	EERR023WL **	3 h	5,6 W - 140 lm	4,8V/2,0Ah NiMH	
Spot	EEQS023WL *	EERS023WL **	3 h	5,6 W - 140 lm	4,8V/2,0Ah NiMH	
<b>LUMINAIRES FOR CORE COMPACT CENTRAL SYSTEMS 24V AC/DC INCL. MONITORING MODULE</b>						
System lens (circular/corridor)	EEQL529CC *	EERL529CC	CPS	1,5 W - 140 lm		
<b>LUMINAIRES FOR CENTRAL BATTERY SYSTEMS AC/DC INCL. MONITORING MODULE</b>						
System lens (circular/corridor)	EEQL039ML *	EERL039ML **	CPS	4,8 W - 470 lm		

\*) Standard: white (RAL 9003) | -AZ: anthracite (RAL 7016)

\*\*) Standard: white (RAL 9003) | -AZ: anthracite (RAL 7016) | -E: stainless steel look (EER only)

## ACCESSORIES



**LSYS-S:** Spotlens for luminaires with lens system. Suitable for ceilings up to 12m.



**LSYS-B:** Beam lens for luminaires with lens system. To illuminate firefighting and help points on the wall.

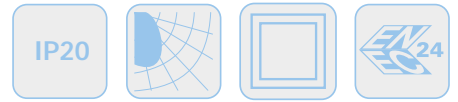

Distance table EExL 031 and EExL 039 with corridor lens for plane emergency routes (additional distance tables on our website)

Montagehöhe (m)					
2.50	3.30	8.67	13.73	18.86	8.55
3.00	3.40	9.04	15.31	21.55	9.70
3.50	3.46	9.33	16.76	24.03	10.71
4.00	3.51	9.55	18.01	26.36	11.31

Distance table EExL 031 and EExL 039 with spot lens for plane emergency routes (additional distance tables on our website)

Montagehöhe (m)					
3.00	2.86	6.62	6.62	6.62	2.86
4.00	3.47	7.77	7.77	7.77	3.47
5.00	4.05	9.09	9.09	9.09	4.05
6.00	4.60	10.17	10.17	10.17	4.60
7.00	5.06	11.39	11.39	11.39	5.06
8.00	5.40	12.52	12.52	12.52	5.40
9.00	5.62	13.52	13.52	13.52	5.62
10.00	5.74	14.39	14.39	14.39	5.74
11.00	5.72	15.10	15.10	15.10	5.72
12.00	5.61	15.60	15.60	15.60	5.61

The distance table is based on the following parameters: Maintenance factor: 0.8; emergency lighting factor 1.00; Minimum illumination on the center line: 1.00 lux; Minimum illumination on the half width of the rescue

route: 0.50 lux, uniformity on the midline maximum 40:1; Width of the rescue route 2.00m

## RECESSED CEILING MOUNTING

Dimensions EER / EEQ

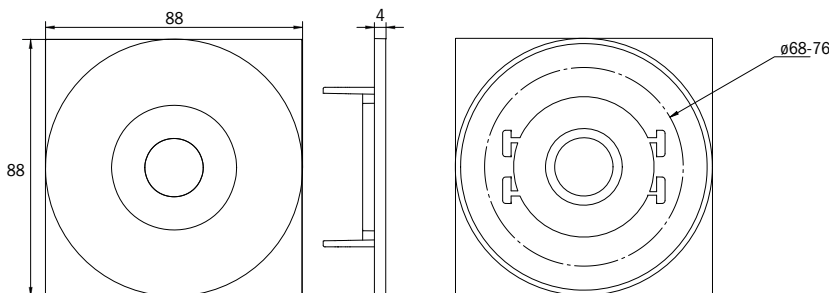

Cut-out EER / EEQ

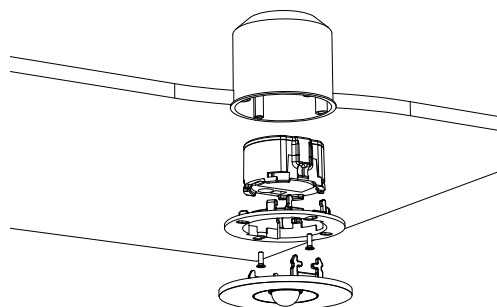
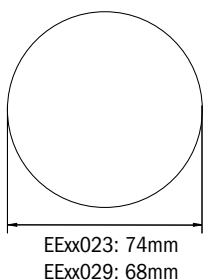

EEx029: Mounting jack necessary (not included in delivery)

SelfContained electronics box (UH-1)

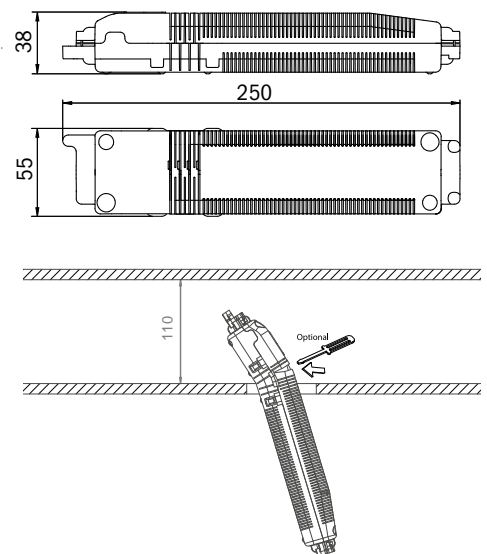

# » E-Series

## SOCKET MOUNTING WITH FUNCTION ENDURANCE

Luminaires of the EEx-series fit due to its very compact design also in a standard connection jack or fire resistant jack, such as Kaiser HWD 30. This allows EEx-luminaires to be installed in fire resistant ceilings of classes F30, F60 and F90 according to DIN 4102-4 or DIN 4102-2 as well. No reworking with fire protection silicone and no additional fire protection housing necessary.

To mount the central battery luminaire in a jack, the lateral ceiling clamps have to be removed and the included adapter ring must be applied (art.-no. EE-EBA).

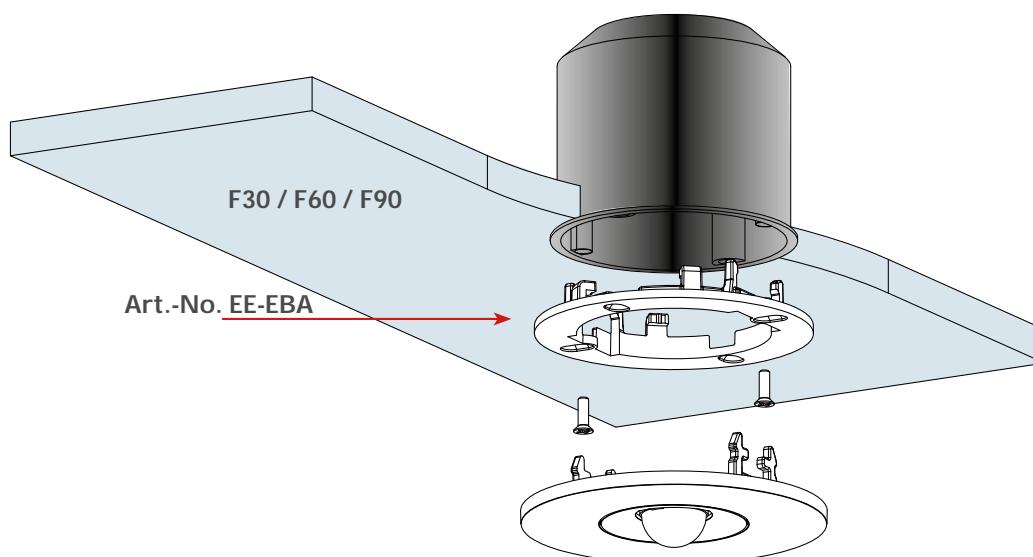





MODULES

ACCESSORIES

WIRELESS MONITORING

GENERAL LIGHTING  
WITH EMERGENCY LIGHT

INDUSTRIAL  
LUMINAIRES

UNIVERSAL  
LUMINAIRES

DYNAMIC  
LUMINAIRES

DESIGN LUMINAIRES

GENERAL  
INFORMATIONS

## EMERGENCY ROUTE LIGHTING

### FACTS

- Zinc die-cast housing
- IP40
- LED Illuminant
- ceiling mounting
- -5° to +40°C

Universal, discreet Zinc die-cast ceiling-mounting cover for the lights ILDR, ILDF and ILDS. For easier installation, the housing can be assembled later.

By using the light IL as a base, you have the advantage of compact storage.

Version	Order numbers
<b>Covers</b>	
Round cover	
... - white	EAR
... - anthracite	EAR-AZ
Square cover	
... - white	EAQ
... - anthracite	EAQ-AZ

### CEILING MOUNTING

Dimensions and drilling distances EAR / EAQ

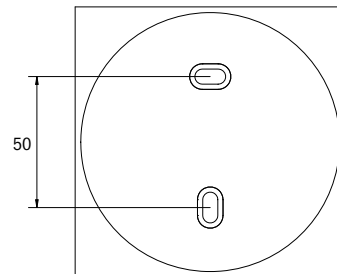
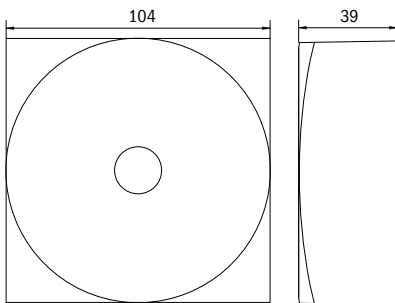

All Dimensions in mm



EAR



EAQ-AZ

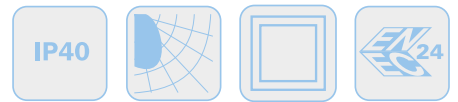

<b>SELF-CONTAINED LUMINAIRES WITH SELFCONTROL MODULE</b>									
System lens (circular/corridor)	EAQL421SC	EAQL421SC-AZ	EARL421SC	EARL421SC-AZ	1 h	3 W - 250 lm	3,2V / 3,3 Ah LiFePO <sub>4</sub>		
System lens (circular/corridor)	EAQL423SC	EAQL423SC-AZ	EARL423SC	EARL423SC-AZ	3 h	3 W - 250 lm	3,2V / 3,3 Ah LiFePO <sub>4</sub>		
System lens (circular/corridor)	EAQL428SC	EAQL428SC-AZ	EARL428SC	EARL428SC-AZ	8 h	3 W - 125 lm	3,2V / 3,3 Ah LiFePO <sub>4</sub>		
<b>SELF-CONTAINED LUMINAIRES WITH WIRELESS BASIC MODULE</b>									
System lens (circular/corridor)	EAQL421WB	EAQL421WB-AZ	EARL421WB	EARL421WB-AZ	1 h	3,4 W - 250 lm	3,2V / 3,3 Ah LiFePO <sub>4</sub>		
System lens (circular/corridor)	EAQL423WB	EAQL423WB-AZ	EARL423WB	EARL423WB-AZ	3 h	3,4 W - 250 lm	3,2V / 3,3 Ah LiFePO <sub>4</sub>		
System lens (circular/corridor)	EAQL428WB	EAQL428WB-AZ	EARL428WB	EARL428WB-AZ	8 h	3,4 W - 125 lm	3,2V / 3,3 Ah LiFePO <sub>4</sub>		
<b>SELF-CONTAINED LUMINAIRES WITH WIRELESS PROFESSIONAL MODULE (SWITCHABLE)</b>									
System lens (circular/corridor)	EAQL421WL	EAQL421WL-AZ	EARL421WL	EARL421WL-AZ	1 h	3,4 W - 250 lm	3,2V / 3,3 Ah LiFePO <sub>4</sub>		
System lens (circular/corridor)	EAQL423WL	EAQL423WL-AZ	EARL423WL	EARL423WL-AZ	3 h	3,4 W - 250 lm	3,2V / 3,3 Ah LiFePO <sub>4</sub>		
System lens (circular/corridor)	EAQL428WL	EAQL428WL-AZ	EARL428WL	EARL428WL-AZ	8 h	3,4 W - 125 lm	3,2V / 3,3 Ah LiFePO <sub>4</sub>		
<b>LUMINAIRES FOR CORE COMPACT CENTRAL SYSTEMS 24V AC/DC INCL. MONITORING MODULE</b>									
System lens (circular/corridor)	EAQL529CC	EAQL529CC-AZ	EARL529CC	EARL529CC-AZ	CPS	2,8 W - 360 lm			
<b>LUMINAIRES FOR CENTRAL BATTERY SYSTEMS AC/DC INCL. MONITORING MODULE</b>									
Circular beam	EAQR029ML	EAQR029ML-AZ	EARR029ML	EARR029ML-AZ	CPS	4,6 W - 360 lm			
Corridor lighting	EAQF029ML	EAQF029ML-AZ	EARF029ML	EARF029ML-AZ	CPS	4,6 W - 360 lm			
Spot	EAQS029ML	EAQS029ML-AZ	EARS029ML	EARS029ML-AZ	CPS	4,6 W - 360 lm			

\*) Standard: white | -AZ: anthracite

## ACCESSORIES



**LSYS-S:** Spotlens for luminaires with lens system. Suitable for ceilings up to 12m.



**LSYS-B:** Beam lens for luminaires with lens system. To illuminate firefighting and help points on the wall.



 **FMW**  
ZINC DIE-CAST EXIT SIGN



## FACTS

- Zinc die-cast housing, white (RAL 9003) or anthracite (RAL 7016)
- IP65
- LED Illuminant
- wall mounting
- Self-Contained: -5° to +40°C  
Central battery systems: -20° to +40°C

Robust wall-mounted Zinc die-cast luminaire for the lighting of escape and rescue routes according to DIN EN 60598-1, DIN EN 605982-22 and EN 1838. Appealing design with concealed screws.

Available for central power systems or as LED self-contained emergency luminaire.



(CBS-Version)

SELF-CONTAINED LUMINAIRES WITH SELFCONTROL MODULE		LUMINAIRES FOR CORE COMPACT CENTRAL SYSTEMS 24V AC/DC INCL. MONITORING MODULE		LUMINAIRES FOR CENTRAL BATTERY SYSTEMS AC/DC INCL. MONITORING MODULE	
LED, 1h, 230V AC	FMW001SC	FMW001SC-AZ	1 h	4,2 W	4,8V/2,0Ah NiMH
LED, 3h, 230V AC	FMW003SC	FMW003SC-AZ	3 h	4,2 W	4,8V/2,0Ah NiMH
LED, 8h, 230V AC	FMW008SC	FMW008SC-AZ	8 h	4,2 W	4,8V/2,0Ah NiMH
LED, 24V AC/DC	FMW509CC	FMW509CC-AZ	CPS	2,2 W	
LED, 230V AC/DC	FMW009ML	FMW009ML-AZ	CPS	3,4 W	

## WALL MOUNTING

Dimensions and drilling distances

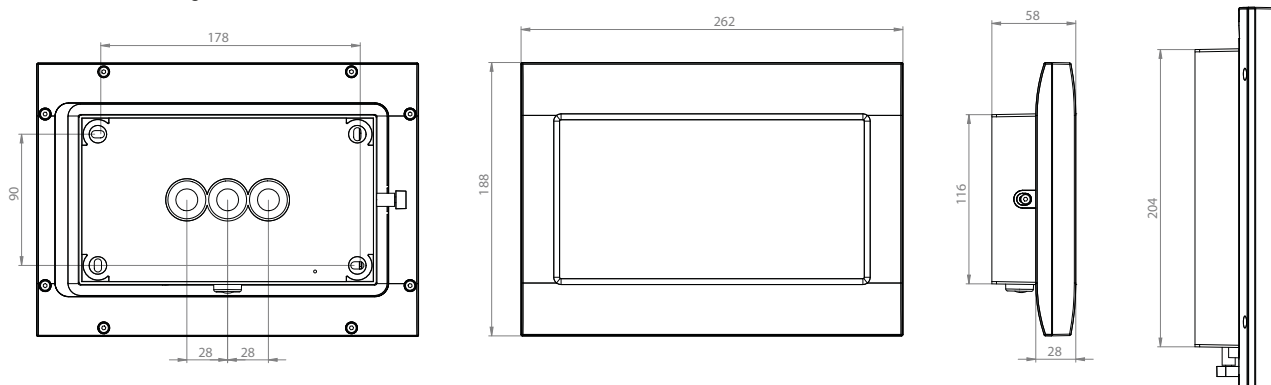

## ACCESSORIES

FMDA - ceiling mounted adapter

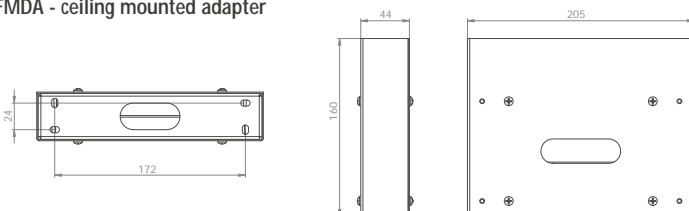

- FMDA001 – single side mounting
- FMDA001-AZ – anthracite, single side mounting
- FMDA002 – double sided mounting
- FMDA002 – anthracite, double sided mounting

All Dimensions in mm



**FMDS**

ZINC DIE-CAST EMERGENCY LUMINAIRE



## FACTS

- Zinc die-cast housing, white or anthracite
- IP65
- LED Illuminant
- ceiling mounting
- -5° to +40°C

Robuste Aufbauleuchte aus Zink Druckguss zur Ausleuchtung der Flucht- und Rettungswege nach DIN EN 60598-1, DIN EN 60598-2-22 und DIN EN 1838.

Ansprechendes Design durch verdeckte Verschraubung. Erhältlich als CPS- oder LED-Einzelbatterie-Leuchte. Ballwurfsicher nach DIN 18032.



<b>SELF-CONTAINED LUMINAIRES WITH SELFCONTROL MODULE</b>				
LED, 1h, 230V AC	FMDS021SC FMDS021SC-AZ	1 h	6 W - 520 lm	4,8V/2,0Ah NiMH
LED, 3h, 230V AC	FMDS023SC FMDS023SC-AZ	3 h	6 W - 260 lm	4,8V/2,0Ah NiMH
LED, 8h, 230V AC	FMDS028SC FMDS028SC-AZ	8 h	7,1 W - 220 lm	9,6V/2,0Ah NiMH
<b>LUMINAIRES FOR CORE COMPACT CENTRAL SYSTEMS 24V AC/DC INCL. MONITORING MODULE</b>				
LED, 24V AC/DC	FMDS529CC FMDS529CC-AZ	CPS	3,8 W - 520 lm	
<b>LUMINAIRES FOR CENTRAL BATTERY SYSTEMS AC/DC</b>				
LED, 230V AC/DC	FMDS029 FMDS029-AZ	CPS	4,6 W - 520 lm	
<b>LUMINAIRES FOR CENTRAL BATTERY SYSTEMS AC/DC INCL. MONITORING MODULE</b>				
LED, 230V AC/DC	FMDS029ML FMDS029ML-AZ	CPS	5,2 W - 520 lm	

Distance table FMDS029(ML) for plane emergency routes

Mounting height (m)					
2.00	4.29	9.63	8.77	6.96	2.86
2.50	4.91	11.50	10.47	8.15	3.20
3.00	5.41	12.74	11.61	8.64	3.33
3.50	5.82	13.99	12.61	9.09	3.50
4.00	6.40	15.13	13.55	9.45	3.60
5.00	7.14	17.12	15.28	10.10	3.76
6.00	7.96	19.04	16.72	10.62	3.90
7.00	8.34	20.68	17.90	11.00	3.88
8.00	8.88	22.10	18.84	11.24	3.90
9.00	9.00	23.34	19.29	11.40	3.81
10.50	8.49	24.87	19.35	11.40	3.42
12.00	7.80	25.47	18.75	11.16	3.00

The distance table is based on the following parameters: Maintenance factor: 0.8; emergency lighting factor 1.00; Minimum illumination on the center line: 1.00 lux; Minimum illumination on the half width of the rescue

route: 0.50 lux, uniformity on the midline maximum 40:1; Width of the rescue route 2.00m



 **WEF**  
RECESSED WALL MOUNTED LUMINAIRE





## FACTS

- Zinc die-cast, white, anthracite or stainless steel look
- IP20
- LED Illuminant
- Recessed wall mounting
- -10° to +40°C

LED emergency luminaire for wall installation and for the lighting of escape and rescue routes according to DIN EN 60598-1, DIN EN 605982-22 and DIN EN 1838.

This recessed luminaire is designed for installation in conventional installation jacks. The mounting frame can be aligned with the jacks.

The zinc die-cast cover is locked without externally visible fastening. Through the status LED which is incorporated in the lens the harmony of the housing is not interrupted.

SELF-CONTAINED LUMINAIRES WITH SELFCONTROL MODULE									
LED, 1h, 230V AC	WEF021SC *	WEF021SC-AZ *	WEF021SC-E *	1 h	5 W - 420 lm	4,8V/2,0Ah NiMH			
LED, 3h, 230V AC	WEF023SC *	WEF023SC-AZ *	WEF023SC-E *	3 h	5 W - 280 lm	4,8V/2,0Ah NiMH			
LED, 8h, 230V AC	WEF028SC *	WEF028SC-AZ *	WEF028SC-E *	8 h	5,9 W - 270 lm	9,6V/2,0Ah NiMH			
LUMINAIRES FOR CORE COMPACT CENTRAL SYSTEMS 24V AC/DC INCL. MONITORING MODULE									
LED, 24V AC/DC	WEF529CC	WEF529CC-AZ	WEF529CC-E	CPS	3,3 W - 420 lm				
LUMINAIRES FOR CENTRAL BATTERY SYSTEMS AC/DC									
LED, 230V AC/DC	WEF029	WEF029-AZ	WEF029-E	CPS	3,9 W - 420 lm				
LUMINAIRES FOR CENTRAL BATTERY SYSTEMS AC/DC INCL. MONITORING MODULE									
LED, 230V AC/DC	WEF029ML	WEF029ML-AZ	WEF029ML-E	CPS	4,3 W - 420 lm				

\*) Lieferung mit UH1-Gehäuse. Inhalt übersteigt gegebenenfalls das Volumen der Einbaudose.

## RECESSED WALL MOUNTING

WEF Dimensions

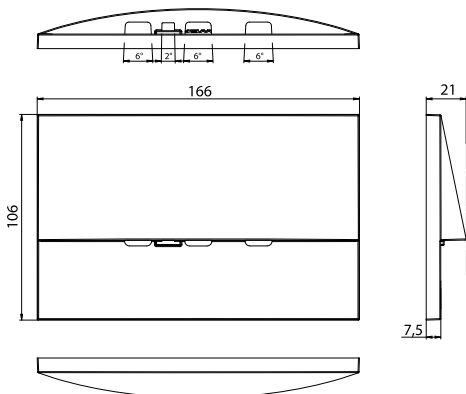

SelfContained electronics box

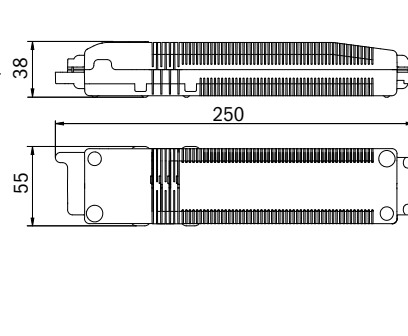

WEF 029(ML) installation socket

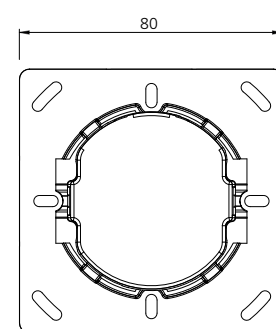

All Dimensions in mm

WEF Illumination

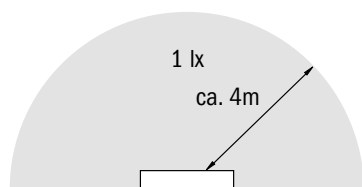

Mounting height 0,5m

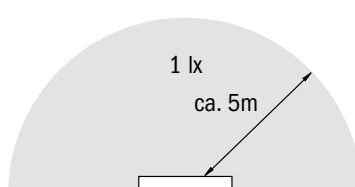

Mounting height 2,2m



 **WER**  
EMERGENCY ROUTE LIGHTING



## FACTS

- Zinc die-cast, white, anthracite or stainless steel look
- IP20
- LED Illuminant
- Recessed wall mounting
- -10° to +40°C

LED emergency luminaire for wall installation for the lighting of escape and rescue routes according to DIN EN 60598-1, DIN EN 605982-22 and DIN EN 1838.

The discreet recessed luminaire is designed for installation in conventional jacks. The mounting frame can be aligned with the jack.

The zinc die-cast cover is locked without externally visible fastening. Through the status LED incorporated in the lens the harmony of the housing is not interrupted.

SELF-CONTAINED LUMINAIRES WITH SELFCONTROL MODULE									
LED, 1h, 230V AC	WER021SC *	WER021SC-AZ *	WER021SC-E *	1 h	3,1 W - 140 lm	4,8V/2,0Ah NiMH			
LED, 3h, 230V AC	WER023SC *	WER023SC-AZ *	WER023SC-E *	3 h	3,1 W - 140 lm	4,8V/2,0Ah NiMH			
LED, 8h, 230V AC	WER028SC *	WER028SC-AZ *	WER028SC-E *	8 h	3,1 W - 120 lm	4,8V/2,0Ah NiMH			
SELF-CONTAINED LUMINAIRES WITH WIRELESS PROFESSIONAL MODULE (SWITCHABLE)									
LED, 1h, 230V AC	WER021WL *	WER021WL-AZ *	WER021WL-E *	1 h	5,6 W - 140 lm	4,8V/2,0Ah NiMH			
LED, 3h, 230V AC	WER023WL *	WER023WL-AZ *	WER023WL-E *	3 h	5,6 W - 140 lm	4,8V/2,0Ah NiMH			
LUMINAIRES FOR CORE COMPACT CENTRAL SYSTEMS 24V AC/DC INCL. MONITORING MODULE									
LED, 24V AC/DC	WER529CC	WER529CC-AZ	WER529CC-E	CPS	1,5 W - 140 lm				
LUMINAIRES FOR CENTRAL BATTERY SYSTEMS AC/DC									
LED, 230V AC/DC	WER029	WER029-AZ	WER029-E	CPS	1,9 W - 140 lm				
LUMINAIRES FOR CENTRAL BATTERY SYSTEMS AC/DC INCL. MONITORING MODULE									
LED, 230V AC/DC	WER029ML	WER029ML-AZ	WER029ML-E	CPS	2,1 W - 140 lm				

\*) Delivered with 1 UH-housing. Content may exceed the volume of the installation socket.

## RECESSED WALL MOUNTING

WER Dimensions

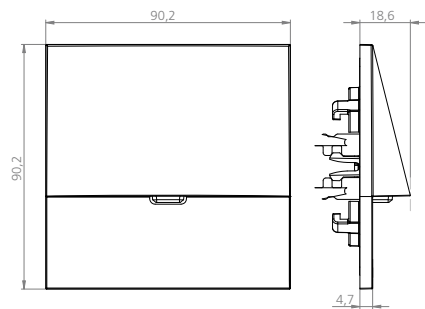

SelfContained electronics box

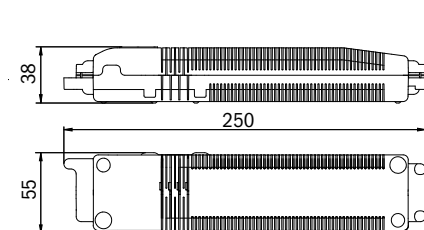

WER 029ML installation socket

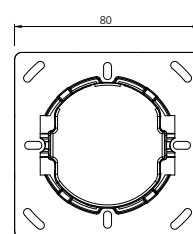

All Dimensions in mm

WER Illumination

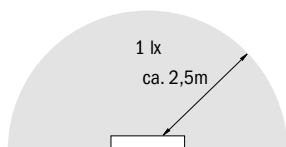

Mounting height 0,5m

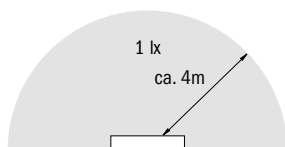

Mounting height 2m



 **WAF**  
EMERGENCY ROUTE LIGHTING



## FACTS

- Zinc die-cast, white, anthracite or stainless steel look
- IP20
- LED Illuminant
- wall mounting
- -10° to +40°C

LED emergency luminaire for surface wall mounting and for the lighting of escape and rescue routes according to DIN EN 60598-1, DIN EN 60598-2-22 and DIN EN 1838.

This luminaire is the perfect solution if a recessed mounting of a WEF or WER luminaire is not possible.

SELF-CONTAINED LUMINAIRES WITH SELFCONTROL MODULE							
LED, 1h, 230V AC	WAF021SC	WAF021SC-AZ	WAF021SC-E	1 h	5 W - 420 lm	4,8V/2,0Ah NiMH	
LED, 3h, 230V AC	WAF023SC	WAF023SC-AZ	WAF023SC-E	3 h	5 W - 280 lm	4,8V/2,0Ah NiMH	
LED, 8h, 230V AC	WAF028SC	WAF028SC-AZ	WAF028SC-E	8 h	5 W - 140 lm	4,8V/2,0Ah NiMH	
LUMINAIRES FOR CORE COMPACT CENTRAL SYSTEMS 24V AC/DC INCL. MONITORING MODULE							
LED, 24V AC/DC	WAF529CC	WAF529CC-AZ	WAF529CC-E	CPS	3,1 W - 420 lm		
LUMINAIRES FOR CENTRAL BATTERY SYSTEMS AC/DC							
LED, 230V AC/DC	WAF029	WAF029-AZ	WAF029-E	CPS	3,9 W - 420 lm		
LUMINAIRES FOR CENTRAL BATTERY SYSTEMS AC/DC INCL. MONITORING MODULE							
LED, 230V AC/DC	WAF029ML	WAF029ML-AZ	WAF029ML-E	CPS	4,5 W - 420 lm		

## WALL MOUNTING

WAF Dimensions

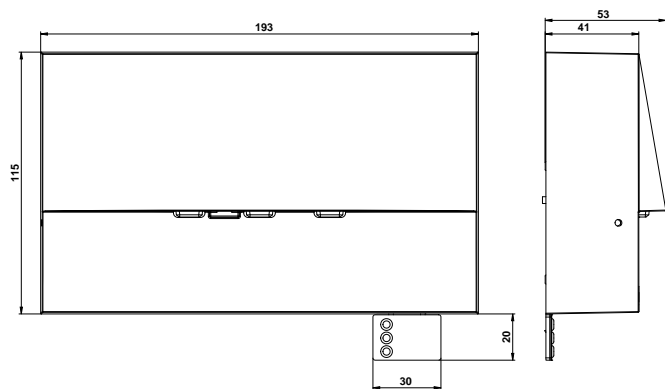

All Dimensions in mm

WAF Illumination

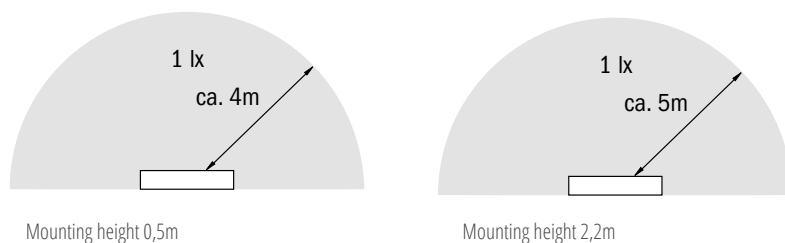



 **ZAW**  
EMERGENCY ROUTE LIGHTING



## FACTS

- Zinc die-cast housing, white or anthracite
- IP65
- LED Illuminant
- wall mounting
- Permissible temperatures:  
ZAW 019ML: -25°C to +40°C \*  
ZAW 013SC/018SC: -5° to +40°C  
ZAW 013SC/018SC-COOL: -25°C to +40°C

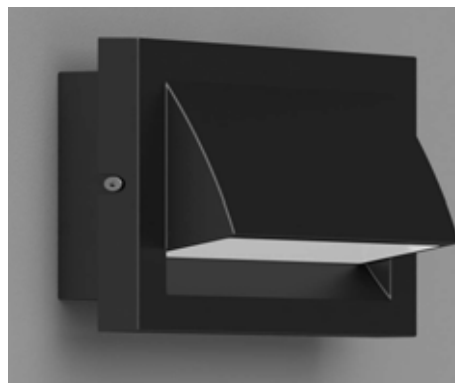

Robust wall-mounted Zinc die-cast luminaire for the lighting of escape and rescue routes in exit areas according to DIN EN 60598-1, DIN EN 60598-2-22 and EN 1838. Appealing design with concealed screws.

Available for central power systems or as a LED self-contained emergency luminaire.

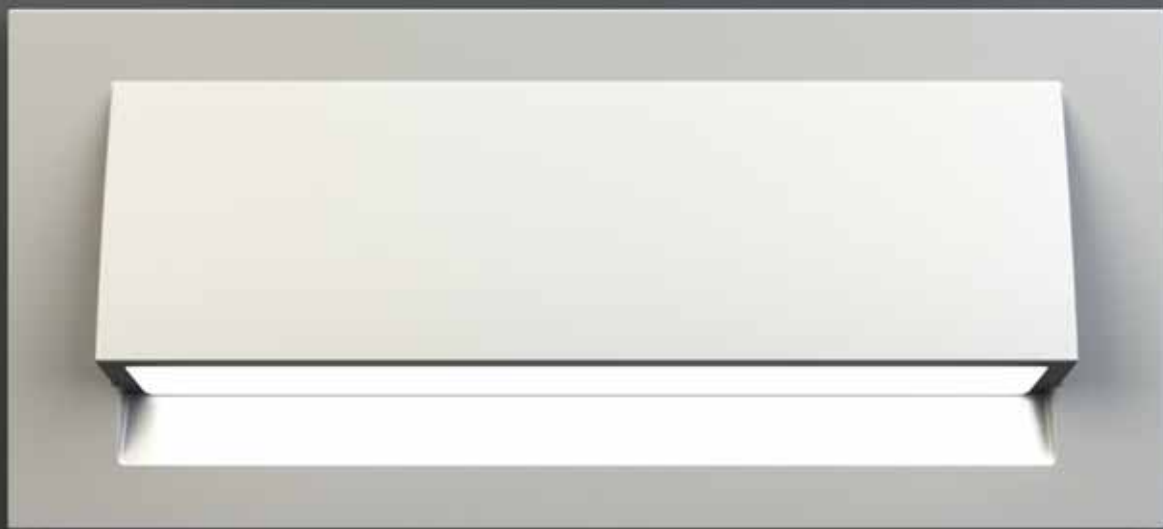

## EMERGENCY ROUTE LIGHTING

<b>SELF-CONTAINED LUMINAIRES WITH SELFCONTROL MODULE</b>						
LED, 1h, 230V AC	ZAW011SC	ZAW011SC-AZ	1 h	4,6 W - 190 lm	3,2V / 3,3 Ah LiFePO4	
LED, 3h, 230V AC	ZAW013SC	ZAW013SC-AZ	3 h	4,6 W - 190 lm	3,2V / 3,3 Ah LiFePO4	
LED, 8h, 230V AC	ZAW018SC	ZAW018SC-AZ	8 h	4,6 W - 85 lm	3,2V / 3,3 Ah LiFePO4	
<b>SELF-CONTAINED LUMINAIRES WITH WIRELESS BASIC MODULE</b>						
LED, 1h, 230V AC	ZAW011WB	ZAW011WB-AZ *	1 h	5,3 W - 190 lm	3,2V / 3,3 Ah LiFePO4	
LED, 3h, 230V AC	ZAW013WB *	ZAW013WB-AZ *	3 h	5,3 W - 190 lm	3,2V / 3,3 Ah LiFePO4	
LED, 8h, 230V AC	ZAW018WB	ZAW018WB-AZ *	8 h	5,3 W - 85 lm	3,2V / 3,3 Ah LiFePO4	
<b>SELF-CONTAINED LUMINAIRES WITH WIRELESS PROFESSIONAL MODULE (SWITCHABLE)</b>						
LED, 1h, 230V AC	ZAW011WL *	ZAW011WL-AZ *	1 h	5,3 W - 190 lm	3,2V / 3,3 Ah LiFePO4	
LED, 3h, 230V AC	ZAW013WL *	ZAW013WL-AZ *	3 h	5,3 W - 190 lm	3,2V / 3,3 Ah LiFePO4	
LED, 8h, 230V AC	ZAW018WL *	ZAW018WL-AZ *	8 h	5,3 W - 85 lm	3,2V / 3,3 Ah LiFePO4	
<b>LUMINAIRES FOR CORE COMPACT CENTRAL SYSTEMS 24V AC/DC INCL. MONITORING MODULE</b>						
LED, 24V AC/DC	ZAW519-CC	ZAW519-CC-AZ	CPS	2,1 W - 220 lm		
<b>LUMINAIRES FOR CENTRAL BATTERY SYSTEMS AC/DC INCL. MONITORING MODULE</b>						
LED, 230V AC/DC	ZAW019ML	ZAW019ML-AZ	CPS	3,2 W - 220 lm		

All versions also available as COOL-luminaires with external battery housing for mounting within the building. The luminaire may be mounted outside or in cool stores

Distance table ZAW011SC, ZAW013SC (-COOL) for plane emergency routes

Mounting height (m)					
2.00	2.18	4.38	7.96	6.51	0.00
2.50	2.35	4.70	8.76	6.88	0.00
3.00	2.45	4.91	9.44	7.13	0.00
3.50	2.49	4.99	8.52	7.40	0.00
4.00	2.45	4.91	7.70	7.48	0.00

The distance table is based on the following parameters: Maintenance factor: 0.8; emergency lighting factor 1.00; Minimum illumination on the center line: 1.00 lux; Minimum illumination on the half width of the rescue

route: 0.50 lux, uniformity on the midline maximum 40:1; Width of the rescue route 2.00m





## WALL MOUNTING

Dimensions ZAW

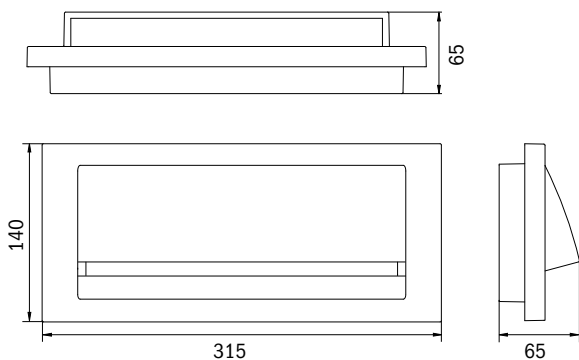

Drilling distances ZAW

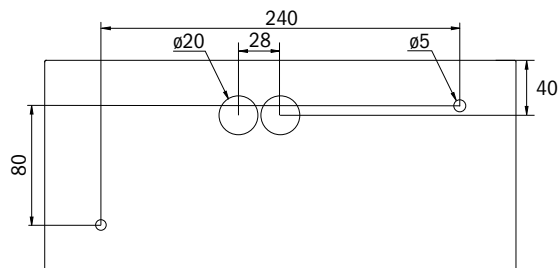

External battery housing -COOL

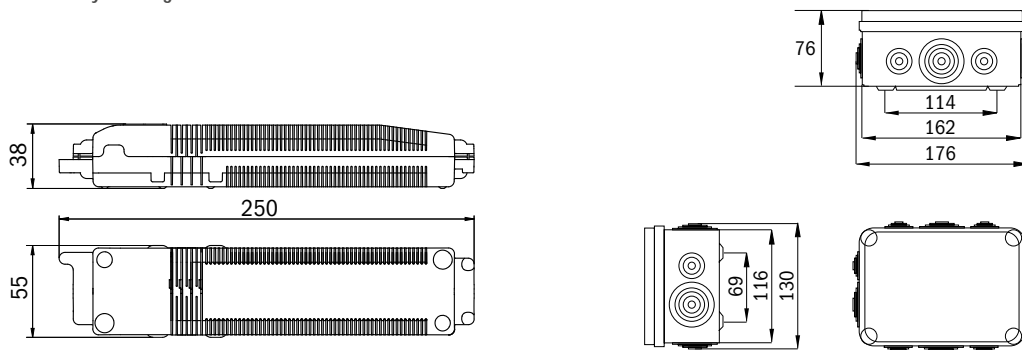

IP20

IP54

All Dimensions in mm

Distance table ZAW019ML for plane emergency routes

Mounting height (m)					
2.00	2.30	4.61	8.34	7.66	0.00
2.50	2.48	4.97	9.18	7.91	0.00
3.00	2.61	5.24	9.93	7.97	0.00
3.50	2.69	5.38	10.50	8.17	0.00
4.00	2.70	5.40	8.63	8.31	0.00

The distance table is based on the following parameters: Maintenance factor: 0.8; emergency lighting factor 1.00; Minimum illumination on the center line: 1.00 lux; Minimum illumination on the half width of the rescue

route: 0.50 lux, uniformity on the midline maximum 40:1; Width of the rescue route 2.00m

\*) For luminaires with metal housing the wireless range may be reduced by 20%

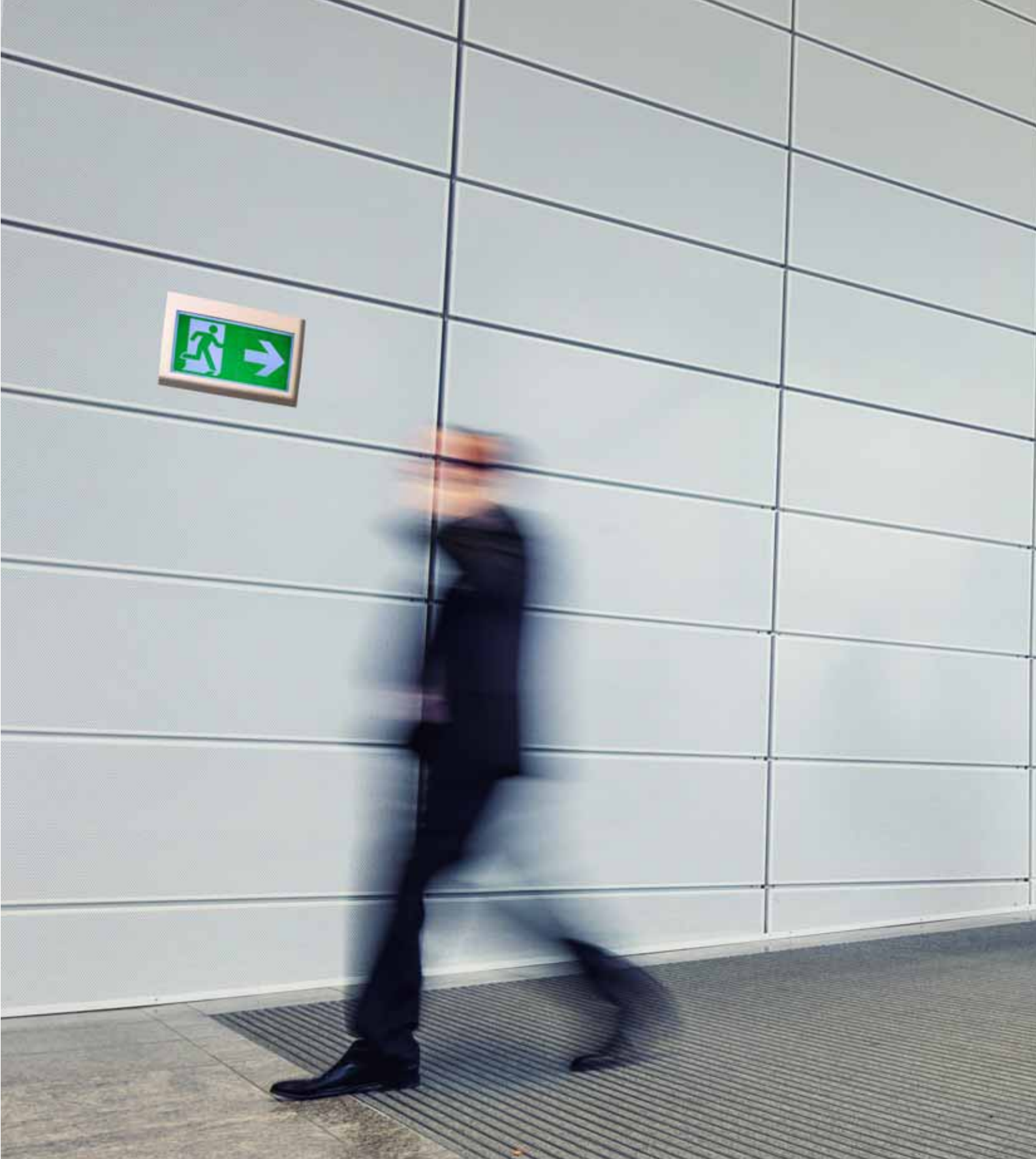

 **DYNAMIC EXIT LUMINAIRE**

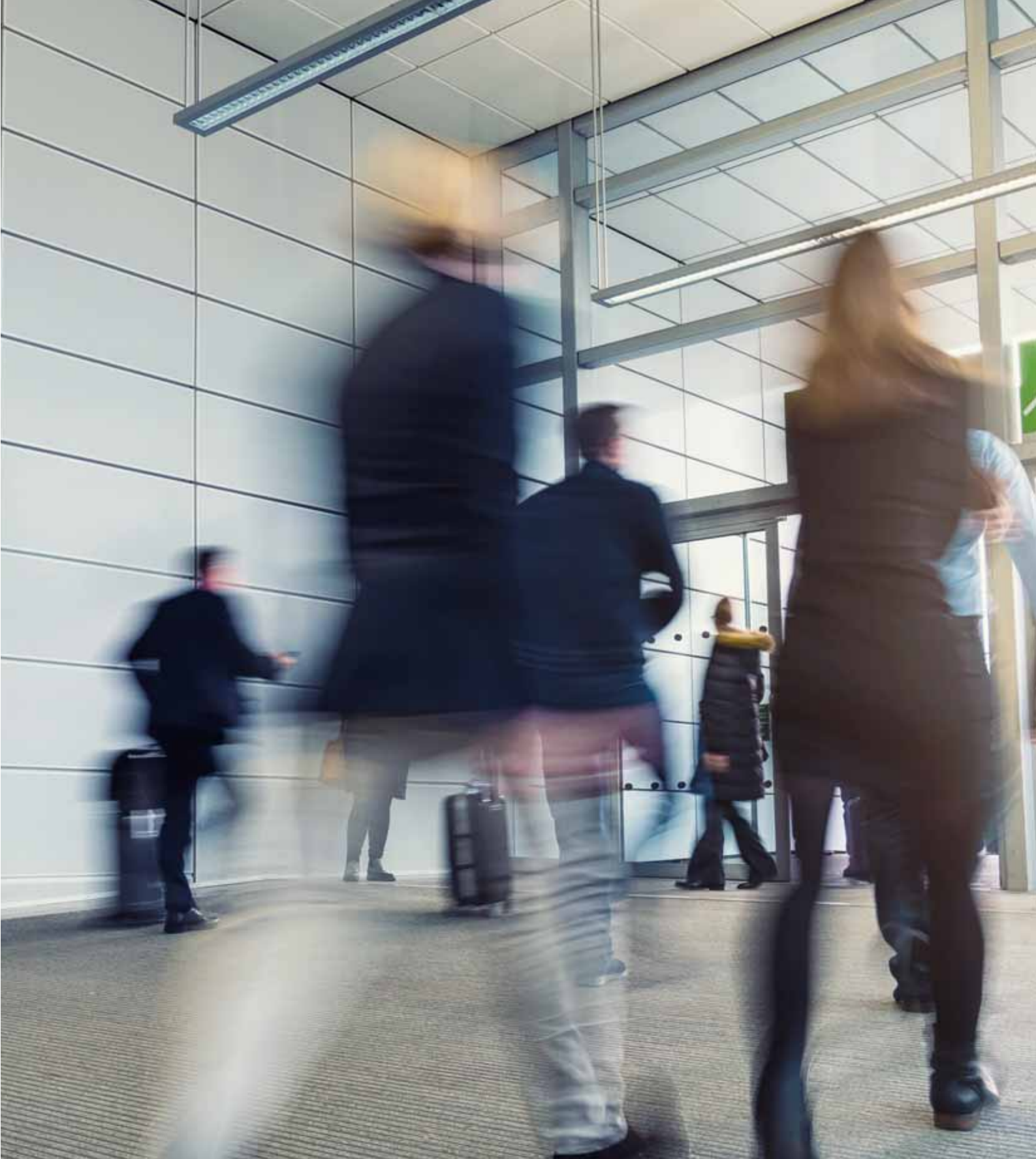



 **FLEXWAY**  
DYNAMIC EXIT SIGN



## FACTS

- Zinc die-cast housing, white
- IP65
- LCD Display for flexible display of 10 different pictographs
- Wall mounting
- Potential free contact for control of the display









The Flexway exit sign is an emergency luminaire for wall mounting which is used to control rescue routes dynamically, so that hazards can be avoided. The pictographs shown can be changed by the control information of a sensor. The Flexway luminaire can present 10 different pictographs. The luminaire is part of an emergency lighting system according to EN 50171 and meets the requirements of EN 60598-2-22. It is designed for connection to central battery systems.

### Flexible display

The Flexway exit sign provides 10 display options. Two operating states are preselectable via rotary coding switches. The different operating states are activated by the dry contact of a smoke detector or fire alarm system. The Flexway features a power limited and monitored output voltage. It is selectable which pictograph appears on the electronics with applied voltage or missing voltage.



## DYNAMIC EXIT SIGN

					
LUMINAIRES FOR CORE COMPACT CENTRAL SYSTEMS 24V AC/DC INCL. MONITORING MODULE					
LCD, 24V AC/DC	FMWD509CC	FMWD509CC-AZ	CPS	3,5 W	
LUMINAIRES FOR CENTRAL BATTERY SYSTEMS AC/DC INCL. MONITORING MODULE					
LCD, 230V AC/DC	FMWD009ML	FMWD009ML-AZ	CPS	5,4 W	

### Technical specifications

Operating voltage LCD Panel 12V DC (7V ... 12V DC) SELV  
 perm. ambient temperature -5°C - +40°C

**LCD**  
 Arrow directions 8  
 Blocking symbol 1  
 Others non-maintained mode  
 Brightness in white 180cd/m2

**Sensor Connection**  
 Output 3,3V DC 20mA  
 Input 3,3V DC  
 Connection cross-section 1,5mm2

### In case of an emergency

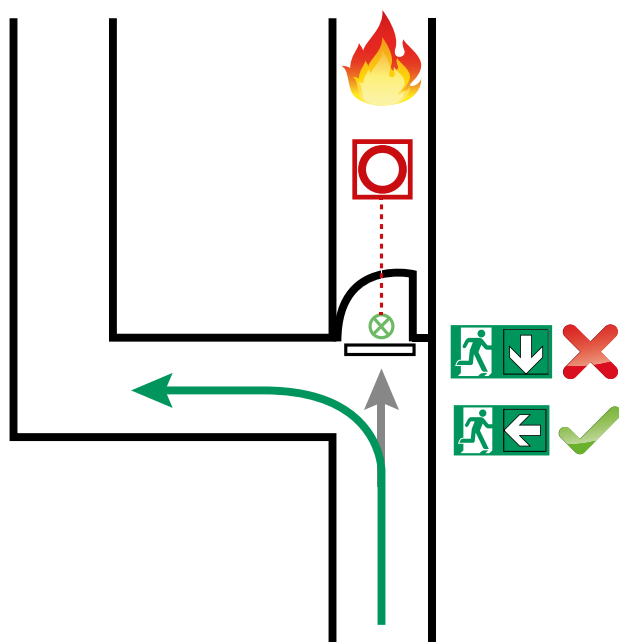

### Displayable pictographs

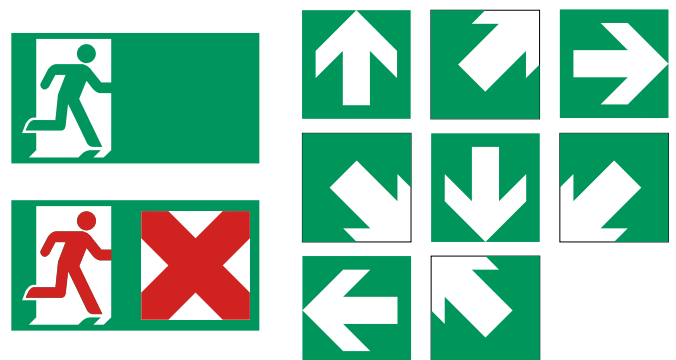



## WALL MOUNTING

Dimensions and drilling distances

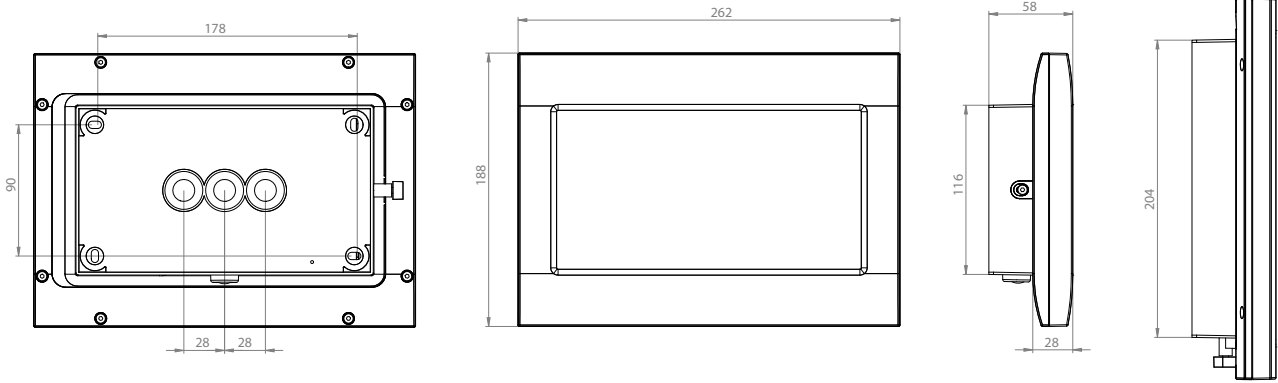

## ACCESSORIES

FMDA - ceiling mount adapter

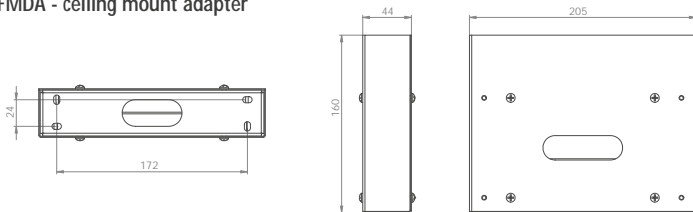

FMDA001 – single side mounting  
 FMDA001-AZ – anthracite, single side mounting

FMDA002 – double sided mounting  
 FMDA002 – anthracite, double sided mounting

All Dimensions in mm



 UNIVERSAL LUMINAIRES







 **KM**  
UNIVERSAL PLASTIC LUMINAIRE



Type Approved  
Safety  
Regular Production  
Surveillance

www.tuv.com  
ID 1111214844

not for KMU001(WL) and KMU003(SC)



GENERAL  
INFORMATIONS

## FACTS

- Plastic, white or black
- Complete set of pictographs (ISO 7010)
- IP43
- Universal mounting
- SelfContained: -5° to +40°C  
Central battery: -30° to +40°C

Emergency sign luminaire in accordance to DIN EN 60598-1, DIN EN 60598-2-22 and DIN EN 1838.

Slim, elegant, convex, synthetic luminaire tilted towards the viewer, continuously symmetrically tapered towards the bottom. For universal mounting (wall/ceiling surface mount/integrated ceiling mount/brackets). For mounting convenience, the luminaire consists of only 3 parts.

Toolfree mountable on the quick assembly integrated ceiling mounting or wall mounting system. The luminaire has zero potential when dismantled.

Suitable for continuous mode or stand-by mode. Reliable planning due to a toolfree and variable, on-site use of the pictograms. Set of pictograms (left, right, down, up) is included in the scope of delivery.



DESIGN  
LUMINAIRES



DYNAMIC  
LUMINAIRES



UNIVERSAL  
LUMINAIRES

INDUSTRIAL  
LUMINAIRES

GENERAL LIGHTING  
WITH EMERGENCY LIGHT

WIRELESS MONITORING

ACCESSORIES

MODULES

## UNIVERSAL PLASTIC LUMINAIRE

	universal	universal				
<b>SELF-CONTAINED LUMINAIRES</b>						
LED, 3h, 230V AC	KMU003	KMU003-SW	3 h	3,1 W	4,8V / 0,5Ah NiMH	
<b>SELF-CONTAINED LUMINAIRES WITH SELFCONTROL MODULE</b>						
LED, 1h, 230V AC	KMU011SC	KMU011SC-SW	1 h	4,6 W	3,2V / 0,57Ah LiFePO4	
LED, 3h, 230V AC	KMU003SC	KMU003SC-SW	3 h	3,1 W	4,8V / 0,5Ah NiMH	
LED, 3h, 230V AC	KMU013SC	KMU013SC-SW	3 h	4,6 W	3,2V / 0,57Ah LiFePO4	
LED, 8h, 230V AC	KMU018SC	KMU018SC-SW	8 h	4,6 W	3,2V / 3,3 Ah LiFePO4	
<b>SELF-CONTAINED LUMINAIRES WITH WIRELESS BASIC MODULE</b>						
LED, 1h, 230V AC	KMU011WB	KMU011WB-SW	1 h	5,3 W	3,2V / 3,3 Ah LiFePO4	
LED, 3h, 230V AC	KMU013WB	KMU013WB-SW	3 h	5,3 W	3,2V / 3,3 Ah LiFePO4	
LED, 8h, 230V AC	KMU018WB	KMU011WB-SW	8 h	5,3 W	3,2V / 3,3 Ah LiFePO4	
<b>SELF-CONTAINED LUMINAIRES WITH WIRELESS PROFESSIONAL MODULE (SWITCHABLE)</b>						
LED, 1h, 230V AC	KMU001WL	KMU001WL-SW	1 h	3,6 W	4,8V / 0,5Ah NiMH	
LED, 1h, 230V AC	KMU011WL	KMU011WL-SW	1 h	5,3 W	3,2V / 3,3 Ah LiFePO4	
LED, 3h, 230V AC	KMU013WL	KMU013WL-SW	3 h	5,3 W	3,2V / 3,3 Ah LiFePO4	
LED, 8h, 230V AC	KMU018WL	KMU018WL-SW	8 h	5,3 W	3,2V / 3,3 Ah LiFePO4	
<b>LUMINAIRES FOR CORE COMPACT CENTRAL SYSTEMS 24V AC/DC INCL. MONITORING MODULE</b>						
LED, 24V AC/DC	KMU519CC	KMU519CC-SW	CPS	2,1 W		
<b>LUMINAIRES FOR CENTRAL BATTERY SYSTEMS AC/DC INCL. MONITORING MODULE</b>						
LED, 230V AC/DC	KMU019ML	KMU019ML-SW	CPS	3,2 W		

## UNIVERSAL MOUNTING

Dimensions KM

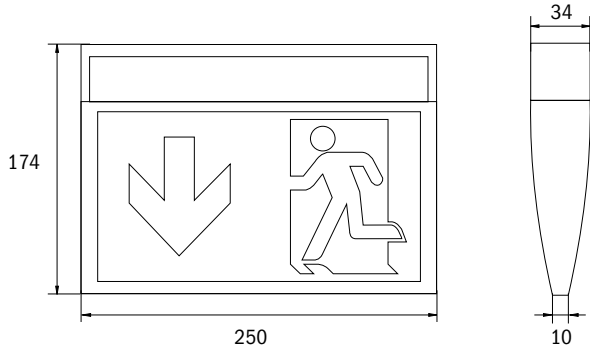

KME recessed mounting frame / cut-out

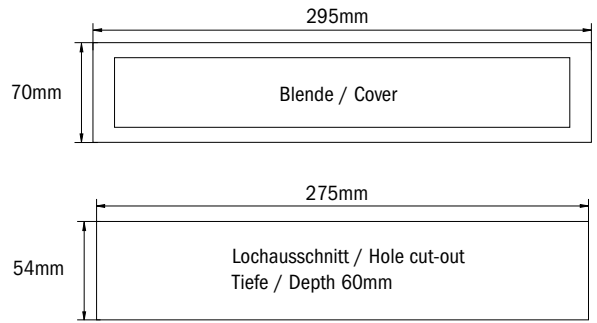

Drilling distances KM ceiling/wall

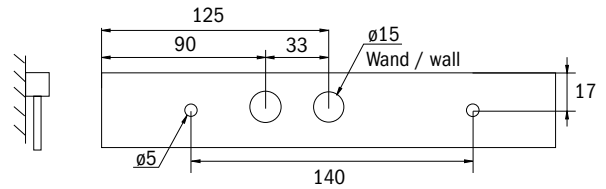
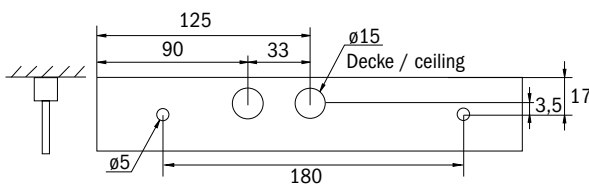

All Dimensions in mm

## ACCESSORIES

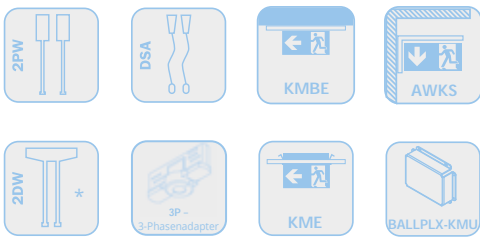

\* (not for KMU013)



**KSU**

UNIVERSAL PLASTIC EDGE LUMINAIRE



Type Approved  
Safety  
Regular Production  
Surveillance

www.tuv.com  
ID 1111214844

nicht für KSU001(WL) und KSU003(SC)



GENERAL  
INFORMATIONS

## FACTS

- Plastic, white
- Complete set of pictographs (ISO 7010)
- IP54
- Universal mounting
- SelfContained: -5° to +40°C  
Central battery: -30° to +40°C

Innovative plastic edge LED luminaire for universal mounting . This luminaire has a simple installation using only 3 parts.

Applicable for maintained or non-maintained operation mode. Improved reliability through easy to install universal use of pictograms. Universal pictogram set (left, right, up, down) included.

Exit sign according to EN 60598-1, EN 605982-22 and EN 1838 norms.



DESIGN LUMINAIRES

DYNAMIC LUMINAIRES

UNIVERSAL LUMINAIRES

INDUSTRIAL LUMINAIRES

GENERAL LIGHTING WITH EMERGENCY LIGHT

WIRELESS MONITORING

ACCESSORIES

MODULES

## KSE-MB

Elegant: optional mounting frame with metal cover

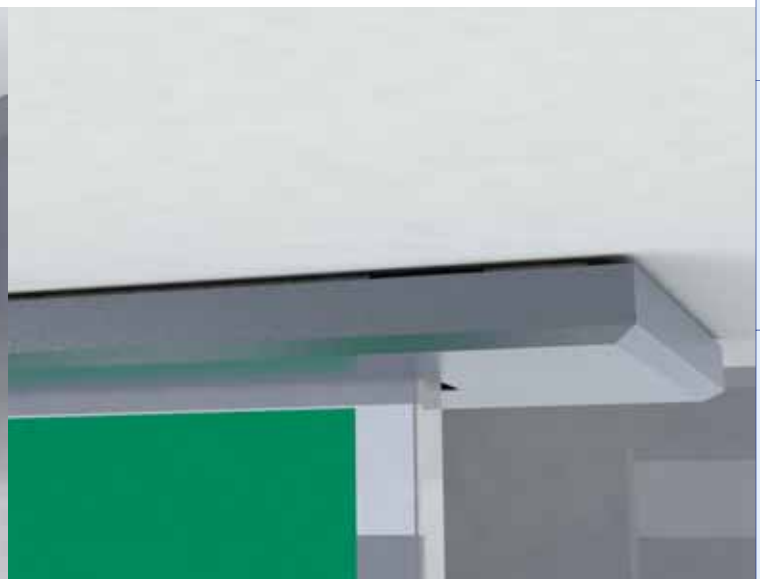



**KSC**

UNIVERSAL PLASTIC EDGE LUMINAIRE





not for KSU001(WL) and KSU003(SC)



GENERAL INFORMATION

## FACTS

- Plastic, white
- Complete set of pictographs (ISO 7010)
- IP54
- Universal mounting
- SelfContained: -5° to +40°C  
Central battery: -30° to +40°C

Innovative high-grade LED exit sign and emergency luminaire for universal mounting. This luminaire has a simple installation using only 3 parts. Applicable for maintained or non-maintained operation mode. Improved reliability through easy to install and universal use of pictograms. Universal pictogram set (left, right, up, down) included.

The KSC luminaire is also designed for illumination of fire fighting and first aid facilities with at least 5 lux on the equipment according to EN 1838.

Signs according to EN 60598-1, EN 60598-2-22 and EN 1838 norms.



DESIGN LUMINAIRES

DYNAMIC LUMINAIRES



UNIVERSAL LUMINAIRES

INDUSTRIAL LUMINAIRES

GENERAL LIGHTING WITH EMERGENCY LIGHT





















WIRELESS MONITORING

ACCESSORIES

MODULES

## UNIVERSAL PLASTIC EDGE LUMINAIRE

### KSU WITH WHITE COVER

				
<b>SELF-CONTAINED LUMINAIRES</b>				
LED, 3h, 230V AC	KSU003	3 h	3,1 W	4,8V / 0,5Ah NiMH
<b>SELF-CONTAINED LUMINAIRES WITH SELFCONTROL MODULE</b>				
LED, 1h, 230V AC	KSU011SC	 1 h	4,6 W	3,2V / 0,57Ah LiFePO4 
LED, 3h, 230V AC	KSU003SC	3 h	3,1 W	4,8V / 0,5Ah NiMH 
LED, 3h, 230V AC	KSU013SC	 3 h	4,6 W	3,2V / 0,57Ah LiFePO4 
LED, 8h, 230V AC	KSU018SC	 8 h	4,6 W	3,2V / 3,3 Ah LiFePO4 
<b>SELF-CONTAINED LUMINAIRES WITH WIRELESS BASIC MODULE</b>				
LED, 1h, 230V AC	KSU011WB	 1 h	5,3 W	3,2V / 3,3 Ah LiFePO4 
LED, 3h, 230V AC	KSU013WB	 3 h	5,3 W	3,2V / 3,3 Ah LiFePO4 
LED, 8h, 230V AC	KSU018WB	 8 h	5,3 W	3,2V / 3,3 Ah LiFePO4 
<b>SELF-CONTAINED LUMINAIRES WITH WIRELESS PROFESSIONAL MODULE (SWITCHABLE)</b>				
LED, 1h, 230V AC	KSU001WL	1 h	3,6 W	4,8V / 0,5Ah NiMH 
LED, 1h, 230V AC	KSU011WL	 1 h	5,3 W	3,2V / 3,3 Ah LiFePO4 
LED, 3h, 230V AC	KSU013WL	 3 h	5,3 W	3,2V / 3,3 Ah LiFePO4 
LED, 8h, 230V AC	KSU018WL	 8 h	5,3 W	3,2V / 3,3 Ah LiFePO4 
<b>LUMINAIRES FOR CORE COMPACT CENTRAL SYSTEMS 24V AC/DC INCL. MONITORING MODULE</b>				
LED, 24V AC/DC	KSU519CC	CPS	2,1 W	
<b>LUMINAIRES FOR CENTRAL BATTERY SYSTEMS AC/DC INCL. MONITORING MODULE</b>				
LED, 230V AC/DC	KSU019ML	 CPS	3,2 W	

## UNIVERSAL MOUNTING

Drilling distances KSU/KSC ceiling/wall

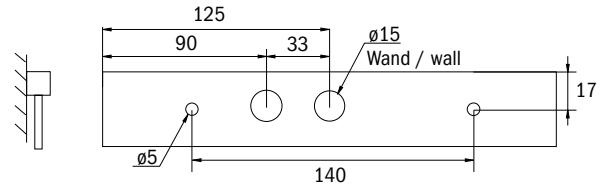
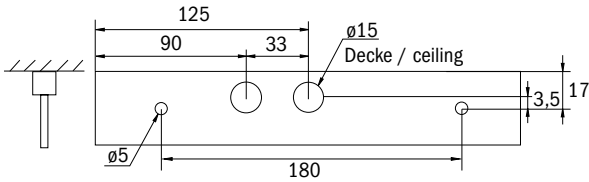

KME / KSE-MB recessed frame

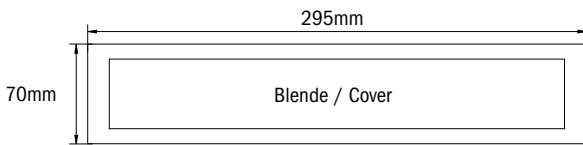

Hole cut-out KME KSE-MB recessed frame

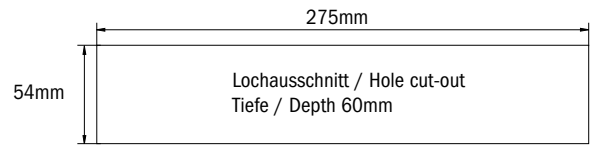

Dimensions KSU/KSC

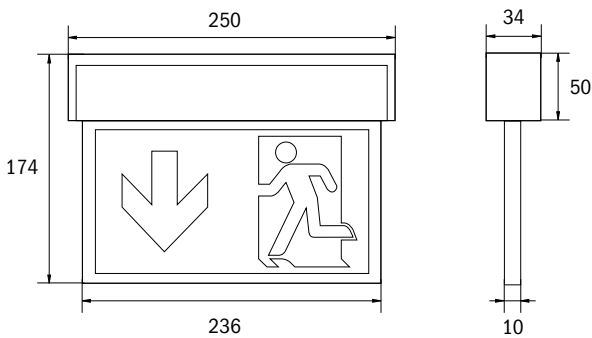

All Dimensions in mm

## ACCESSORIES

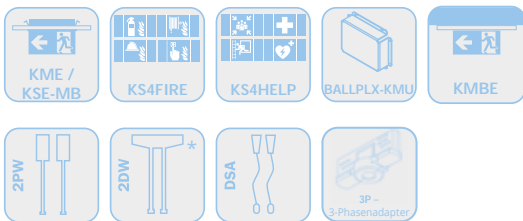

\* (not for KSU/KSC013)

## UNIVERSAL PLASTIC EDGE LUMINAIRE

### KSC WITH CLEAR COVER

					
<b>SELF-CONTAINED LUMINAIRES WITH SELFCONTROL MODULE</b>					
LED, 1h, 230V AC	KSC011SC		1 h	4,6 W - 190 lm	3,2V / 3,3 Ah LiFePO4 
LED, 3h, 230V AC	KSC013SC		3 h	4,6 W - 190 lm	3,2V / 3,3 Ah LiFePO4 
LED, 8h, 230V AC	KSC018SC		8 h	4,6 W - 85 lm	3,2V / 3,3 Ah LiFePO4 
<b>SELF-CONTAINED LUMINAIRES WITH WIRELESS BASIC MODULE</b>					
LED, 1h, 230V AC	KSC011WB		1 h	5,3 W - 190 lm	3,2V / 3,3 Ah LiFePO4 
LED, 3h, 230V AC	KSC013WB		3 h	5,3 W - 190 lm	3,2V / 3,3 Ah LiFePO4 
LED, 8h, 230V AC	KSC018WB		8 h	5,3 W - 85 lm	3,2V / 3,3 Ah LiFePO4 
<b>SELF-CONTAINED LUMINAIRES WITH WIRELESS PROFESSIONAL MODULE (SWITCHABLE)</b>					
LED, 1h, 230V AC	KSC011WL		1 h	5,3 W - 190 lm	3,2V / 3,3 Ah LiFePO4 
LED, 3h, 230V AC	KSC013WL		3 h	5,3 W - 190 lm	3,2V / 3,3 Ah LiFePO4 
LED, 8h, 230V AC	KSC018WL		8 h	5,3 W - 85 lm	3,2V / 3,3 Ah LiFePO4 
<b>LUMINAIRES FOR CORE COMPACT CENTRAL SYSTEMS 24V AC/DC INCL. MONITORING MODULE</b>					
LED, 24V AC/DC	KSC519CC		CPS	2,1 W - 220 lm	
<b>LUMINAIRES FOR CENTRAL BATTERY SYSTEMS AC/DC INCL. MONITORING MODULE</b>					
LED, 230V AC/DC	KSC019ML		CPS	3,2 W - 220 lm	



Type Approved  
Safety  
Regular Production  
Surveillance

www.tuv.com  
ID 1111214844

not for KSU001(WL) and KSU003(SC)



GENERAL  
INFORMATIONS

Distance table KSC013 for plane emergency routes

Mounting height (m)					
2.00	2.86	7.25	7.12	6.94	2.65
2.50	1.27	7.68	7.64	7.32	2.98
3.00	1.15	6.47	6.16	7.91	2.90
3.50	1.14	3.71	6.05	8.37	2.64
4.00	1.15	3.34	5.69	8.38	2.50

DESIGN LUMINAIRES

DYNAMIC  
LUMINAIRES

Illumination KSC013 – 1m above the ground,  
Mounting height of the luminaire 2,20m

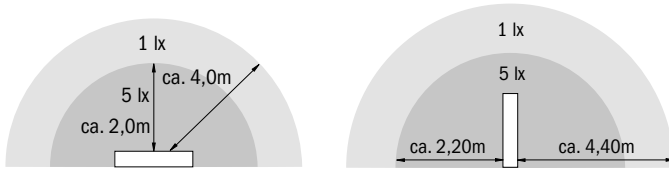

ACCESSORIES

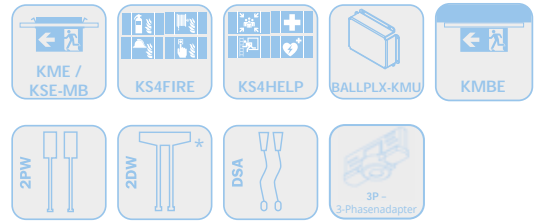

\* (not for KSU/KSC013)

UNIVERSAL  
LUMINAIRES

INDUSTRIAL  
LUMINAIRES



GENERAL LIGHTING  
WITH EMERGENCY LIGHT

WIRELESS MONITORING

ACCESSORIES

MODULES



**KBU**

MODULAR EMERGENCY AND EXIT SIGN LUMINAIRE



## FACTS

- Plastic, white
- Emergency luminaire
- Can be converted into an exit sign luminaire with a viewing distance of 14-30m using optional pane sets
- Included with the optional pane set: Complete pictogram set (ISO 7010)
- IP64
- Universal mounting
- Permissible Temperature:  
 -5°C to +40°C;  
 KBU019/KBU029/KBDUO029:  
 -30°C to +40°C \*  
 KBU013-COOL: -30°C to +40°C

LED exit sign / emergency light according to DIN EN 60598-1, EN 60598-2-22, EN 7010 and DIN EN 1838. Cuboid plastic housing, discreetly reduced design on the lamps substance. Modular design and universal mounting for use as emergency luminaire with and without the application of pictograms.

The modular system allows the light to be converted at any time without dismantling and tools to a exit sign luminaire. Panes for mounting pictographs have to be ordered separately.

### Advantages KB-DUO

Illumination of pictographs in normal operation with normal high power LED. In emergency operation the luminaire switches to the integrated ERT-LED for lighting escape routes as well as the pictograph. The use of special lenses and high performance ERT LED technology ensures a optimal light distribution in the escape and rescue route. This makes large luminaire distances possible.

You get planning safety by variable use and toolless change of pictographs.



\*) The luminaires can be operated with individual luminaire monitoring in mixed mode circuits (1h-preheating time) and in maintained mode circuits or without individual luminaire monitoring in all circuit types.

## MODULAR EMERGENCY AND EXIT SIGN LUMINAIRE

<b>SELF-CONTAINED LUMINAIRES WITH SELFCONTROL MODULE</b>						
LED, 1h, 230V AC	KBU011SC	KBU011SC-COOLIP54 *	1 h	6,1 W - 300 lm	4,8V/2,0Ah NiMH	
LED, 1h, 230V AC	KBU021SC	KBU021SC-COOLIP54 *	1 h	6 W - 520 lm	4,8V/2,0Ah NiMH	
LED, 3h, 230V AC	KBU013SC	KBU013SC-COOLIP54 *	3 h	6,1 W - 150 lm	4,8V/2,0Ah NiMH	
LED, 3h, 230V AC	KBU023SC		3 h	6 W - 520 lm	4,8V/2,0Ah NiMH	
LED, 8h, 230V AC	KBU018SC	KBU018SC-COOLIP54 *	8 h	6,7 W - 160 lm	9,6V/2,0Ah NiMH	
<b>SELF-CONTAINED LUMINAIRES WITH WIRELESS PROFESSIONAL MODUL (NOT SWITCHABLE)</b>						
LED, 3h, 230V AC	KBU011WL	KBU011WL-COOLIP54 *	3 h	7,5 W - 150 lm	12V/0,8Ah NiMH	
LED, 8h, 230V AC	KBU018WL	KBU018WL-COOLIP54 *	8 h	7,5 W - 60 lm	12V/0,8Ah NiMH	
<b>LUMINAIRES FOR CORE COMPACT CENTRAL SYSTEMS 24V AC/DC INCL. MONITORING MODULE</b>						
LED, 24V AC/DC	KBU519CC		CPS	3,6 W - 340 lm		
LED, 24V AC/DC	KBU529CC		CPS	3,8 W - 520 lm		
<b>LUMINAIRES FOR CENTRAL BATTERY SYSTEMS AC/DC</b>						
LED, 230V AC/DC	KBU019		CPS	4,5 W - 300 lm		
LED, 230V AC/DC	KBU029		CPS	4,6 W - 520 lm		
<b>LUMINAIRES FOR CENTRAL BATTERY SYSTEMS AC/DC INCL. MONITORING MODULE</b>						
LED, 230V AC/DC	KBU019ML		CPS	5,2 W - 300 lm		
LED, 230V AC/DC	KBU029ML		CPS	5,2 W - 520 lm		
LED, 230V AC/DC	KBDUO029ML		CPS	5,9 W - 520 lm		

\*) All versions also available as COOL-luminaires with external battery housing in IP 54 for mounting within the building. The luminaire may be mounted outside or in cool stores.

### Comparison of light distribution KBU / KB-DUO

KB-DUO: Illumination of the pictograms in normal operation by means of high power LED. In emergency mode, the lighting is switched to the integrated ERT LEDs for additional illumination of the escape routes and the pictogram.

Optimum light distribution and illumination of escape and rescue routes is achieved by using diffuser lenses and high-power LED ERT technology. This means that extremely wide mounting distances can be achieved.

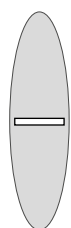

KBU 029

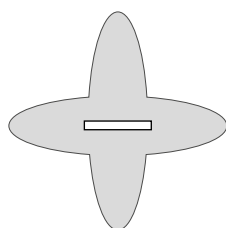

KB-DUO



**Safety light and exit sign in one**



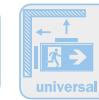

Distance table KBDOU 029ML in Ceilingmontage for plane emergency routes

Mounting height (m)					
2.00	6.97	16.50	14.69	8.24	3.33
2.50	8.18	18.99	16.85	9.00	3.57
3.00	9.23	21.29	18.76	9.68	3.70
3.50	9.62	23.41	20.49	10.26	3.75
4.00	10.42	25.35	22.07	10.50	3.73

The distance table is based on the following parameters: Maintenance factor: 0.8; emergency lighting factor 1.00; Minimum illumination on the center line: 1.00 lux; Minimum illumination on the half width of the rescue

route: 0.50 lux, uniformity on the midline maximum 40:1; Width of the rescue route 2.00m

## UNIVERSAL MOUNTING

Dimensions KBU ceiling

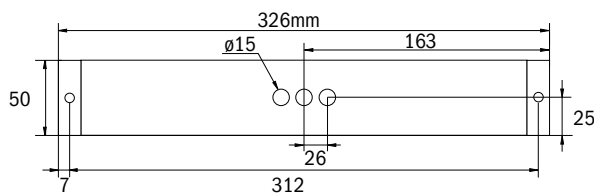

Dimensions KBU wall

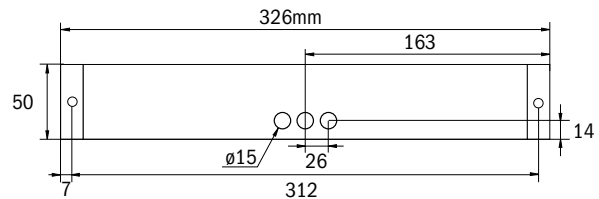

Cut-out for KB recessed frame

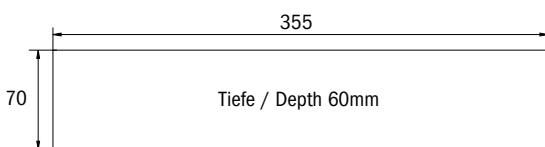

All Dimensions in mm

External battery housing -COOLIP54

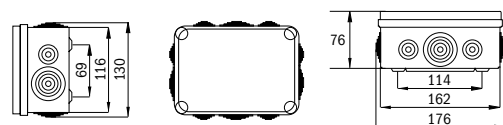

## ACCESSORIES

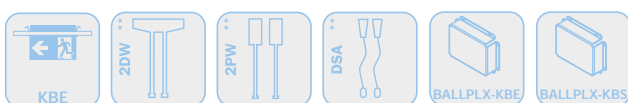
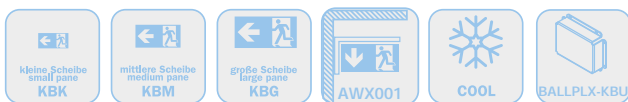

\*\* When mounting with cord suspension or pendulum IP40



 **KX**  
PLASTIC EDGE LUMINAIRE



GENERAL INFORMATION

## FACTS

- Plastic, white
- 30m Viewing distance
- Complete set of pictographs (ISO 7010)
- IP40
- Universal mounting
- SelfContained: -5° to +40°C  
Central battery: -30° to +40°C

Innovative plastic edge luminaire for universal mounting wall/ceiling/recessed ceiling. Tapered design housing for appealing area perception. Applicable for maintained or nonmaintained operation mode.

Improved reliability through easy to install universal use of pictograms. Universal insertion pictogram set (left, right, down, up) included. Signs according to EN 60598-1, EN 60598-2-22 and EN 1838 norms.

- Also available as combined safety light/rescue sign with ERT-LED and clear cover
- Simple pictogram mounting (one and double-sided), plugging-technique



DESIGN LUMINAIRES



DYNAMIC LUMINAIRES

UNIVERSAL LUMINAIRES

INDUSTRIAL LUMINAIRES

GENERAL LIGHTING WITH EMERGENCY LIGHT





















WIRELESS MONITORING

ACCESSORIES

MODULES

## PLASTIC EDGE LUMINAIRE

					
<b>SELF-CONTAINED LUMINAIRES WITH SELFCONTROL MODULE</b>					
LED, 1h, 230V AC	KXU021SC - with clear cover	1 h	6 W - 520 lm	4,8V/2,0Ah NiMH	
LED, 1h, 230V AC	KXU011SC - with clear cover	1 h	6,1 W - 300 lm	4,8V/2,0Ah NiMH	
LED, 1h, 230V AC	KXU001SC - with white cover	1 h	3,1 W	4,8V/2,0Ah NiMH	
LED, 3h, 230V AC	KXU003SC - with white cover	3 h	3,0 W	4,8V/2,0Ah NiMH	
LED, 3h, 230V AC	KXU013SC - with clear cover	3 h	6,1 W - 150 lm	4,8V/2,0Ah NiMH	
LED, 3h, 230V AC	KXU023SC - with clear cover	3 h	6 W - 260 lm	4,8V/2,0Ah NiMH	
LED, 8h, 230V AC	KXU018SC - with clear cover	8 h	6,7 W - 160 lm	9,6V/2,0Ah NiMH	
LED, 8h, 230V AC	KXU008SC - with white cover	8 h	4,2 W	9,6V/2,0Ah NiMH	
<b>SELF-CONTAINED LUMINAIRES WITH WIRELESS PROFESSIONAL MODUL</b>					
LED, 1h, 230V AC	KXU011WL - with clear cover	1 h	7,5 W - 150 lm	12V/0,8Ah NiMH	
LED, 3h, 230V AC	KXU001WL - with white cover	1 h	5,3 W	4,8V/2,0Ah NiMH	
LED, 3h, 230V AC	KXU013WL - with clear cover	3 h	7,5 W - 150 lm	12V/0,8Ah NiMH	
LED, 8h, 230V AC	KXU018WL - with white cover	8 h	7,5 W	12V/0,8Ah NiMH	
<b>LUMINAIRES FOR CENTRAL BATTERY SYSTEMS AC/DC</b>					
LED, 230V AC/DC	KXU029 - with clear cover	CPS	4,6 W - 520 lm		
LED, 230V AC/DC	KXU019 - with clear cover	CPS	4,5 W - 300 lm		
<b>LUMINAIRES FOR CENTRAL BATTERY SYSTEMS AC/DC INCL. MONITORING MODULE</b>					
LED, 230V AC/DC	KXU029ML - with clear cover	CPS	5,2 W - 520 lm		
LED, 230V AC/DC	KXU019ML - with clear cover	CPS	5,2 W - 300 lm		

## UNIVERSAL MOUNTING

Dimensions KXU

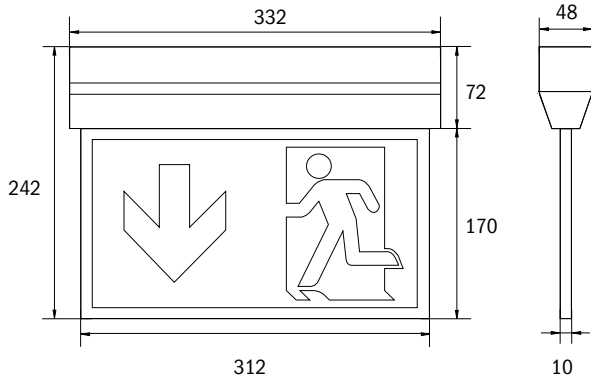

Cut-out KXE recessed frame

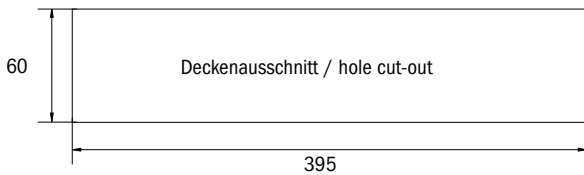

Drilling distances KXU

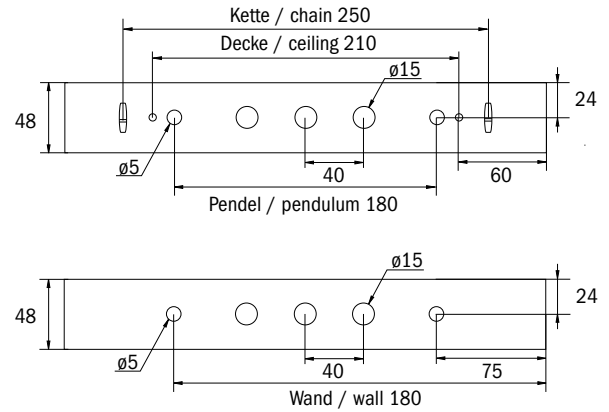

Dimensions KXE recessed frame

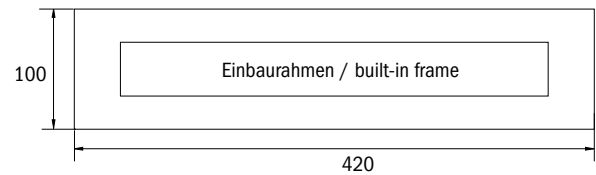

All Dimensions in mm

## ACCESSORIES

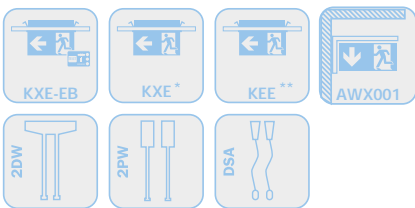

\* KXE: for emergency sign luminaires

\*\* KEE: for combination emergency sign luminaires & rescue sign luminaire

Distance table KXU029 mit klarer Haube for plane emergency routes

Mounting height (m)					
2.00	8.02	19.70	16.50	5.35	2.00
2.50	8.72	21.94	18.24	5.64	1.95
3.00	9.23	23.93	19.32	5.75	1.87
3.50	9.62	25.62	20.24	5.70	1.63
4.00	9.90	26.71	20.65	5.51	1.30

The distance table is based on the following parameters: Maintenance factor: 0.8; emergency lighting factor 1.00; Minimum illumination on the center line: 1.00 lux; Minimum illumination on the half width of the rescue

route: 0.50 lux, uniformity on the midline maximum 40:1; Width of the rescue route 2.00m

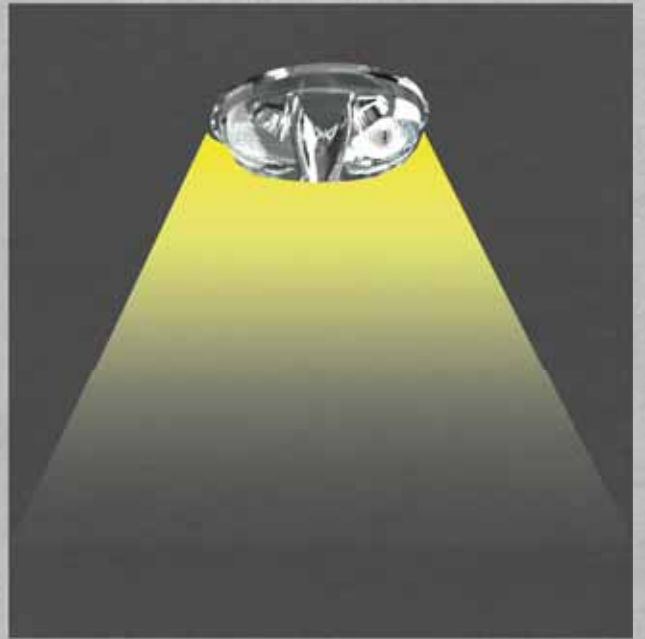

 **IL**  
EMERGENCY ROUTE LIGHTING



GENERAL INFORMATION

## FACTS

- Plastic, white or black
- Ceiling or recessed mounting
- -5°C to +40°C;
- For ILDx029: -20° to +30° C in IL-IP65 housing
- ILDR: IP40; ILE: IP20
- For self-contained luminaires test switch is integrated in LED
- As luminaire for central battery systems with dimming function for reduced blinding effect
- Pluggable corridor or round lens for full flexibility at the installation site

The discreet designed LED emergency luminaire IL is a true all-rounder. Whether as self-contained emergency light or for connection to central battery systems: it is ready for almost all requirements and provides always the right solution. As many as four different lenses for different light distribution are available and make a perfect adaptation to the respective mounting situation possible. All versions of the IL are available for surface mounting and as recessed mounted luminaire.

The IL surface mounted luminaire consists of 2 parts, the ceiling mounted bar includes the power supply terminals. The actual luminaire is mounted without tools and is at disassembly mains voltage free.

The status LED within the lens does not disturb the homogenous look of the luminaire.

**ILDR / ILER**  
Radiate beam for escape routes with ceiling heights up to 4m.

**ILDF / ILEF**  
Focused lens in two main directions for luminaire distances of up to 24m at ceiling heights of up to 4m.

**ILDH / ILEH**  
Special lens with focused light in two main directions. For luminaire distances of over 30m at ceiling heights of up to 16m.

**ILDS / ILES**  
The spot lens ensures an even distribution of light in all directions, even with ceiling heights over 4m.

**ILDL / ILEL**  
The innovative integrated lens socket with quick-mounting device enables flexible use of different lens types depending on the application. Round and corridor lenses are already included with every luminaire.



DESIGN LUMINAIRES

DYNAMIC LUMINAIRES



UNIVERSAL LUMINAIRES

INDUSTRIAL LUMINAIRES

GENERAL LIGHTING WITH EMERGENCY LIGHT



WIRELESS MONITORING

ACCESSORIES

MODULES

## EMERGENCY ROUTE LIGHTING

<b>SELF-CONTAINED LUMINAIRES WITH SELFCONTROL MODULE</b>							
System lens (radial/corridor)	ILD421SC	ILD421SC-SW	ILE421SC	1 h	3 W - 250 lm	3,2V / 3,3 Ah LiFePO <sub>4</sub>	
System lens (radial/corridor)	ILD423SC	ILD423SC-SW	ILE423SC	3 h	3 W - 250 lm	3,2V / 3,3 Ah LiFePO <sub>4</sub>	
System lens (radial/corridor)	ILD428SC	ILD428SC-SW	ILE428SC	8 h	3 W - 125 lm	3,2V / 3,3 Ah LiFePO <sub>4</sub>	
<b>SELF-CONTAINED LUMINAIRES WITH WIRELESS BASIC MODULE</b>							
System lens (radial/corridor)	ILD421WB	ILD421WB-SW	ILE421WB	1 h	3,4 W - 250 lm	3,2V / 3,3 Ah LiFePO <sub>4</sub>	
System lens (radial/corridor)	ILD423WB	ILD423WB-SW	ILE423WB	3 h	3,4 W - 250 lm	3,2V / 3,3 Ah LiFePO <sub>4</sub>	
System lens (radial/corridor)	ILD428WB	ILD428WB-SW	ILE428WB	8 h	3,4 W - 125 lm	3,2V / 3,3 Ah LiFePO <sub>4</sub>	
<b>SELF-CONTAINED LUMINAIRES WITH WIRELESS PROFESSIONAL MODULE (SWITCHABLE)</b>							
System lens (radial/corridor)	ILD421WL	ILD421WL-SW	ILE421WL	1 h	3,4 W - 250 lm	3,2V / 3,3 Ah LiFePO <sub>4</sub>	
System lens (radial/corridor)	ILD423WL	ILD423WL-SW	ILE423WL	3 h	3,4 W - 250 lm	3,2V / 3,3 Ah LiFePO <sub>4</sub>	
System lens (radial/corridor)	ILD428WL	ILD428WL-SW	ILE428WL	8 h	3,4 W - 125 lm	3,2V / 3,3 Ah LiFePO <sub>4</sub>	
<b>LUMINAIRES FOR CORE COMPACT CENTRAL SYSTEMS 24V AC/DC INCL. MONITORING MODULE</b>							
System lens (radial/corridor)	ILD529CC	ILD529CC-SW	ILE529CC	CPS	2,8 W - 360 lm		
<b>LUMINAIRES FOR CENTRAL BATTERY SYSTEMS AC/DC INCL. MONITORING MODULE</b>							
Radial beam	ILD029ML	ILD029ML-SW	ILER029ML	CPS	4,6 W - 360 lm		
Corridor lighting	ILD029ML	ILD029ML-SW	ILEF029ML	CPS	4,6 W - 360 lm		
For high ceilings	ILDH029ML	ILDH029ML-SW	ILEH029ML	CPS	4,6 W - 360 lm		
Spot	ILDS029ML	ILDS029ML-SW	ILES029ML	CPS	4,6 W - 360 lm		

The emergency luminaire IL(E/D)H is available only for connection to central battery systems. Thanks to the special design of the lens the light of the ERT-LED is very concentrated in the predetermined

direction and thus allows at mounting heights of more than 8m luminaire distances of more than 30m in corridors.



## CEILING MOUNTING / RECESSED CEILING MOUNTING

Dimensions and cut-out ILE (self-contained and central battery systems)

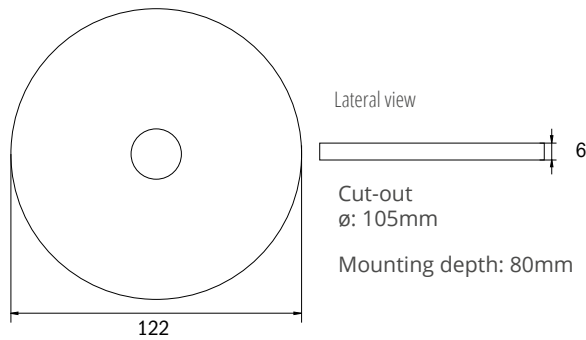

Dimensions and drilling distances  
(self-contained and central battery systems)

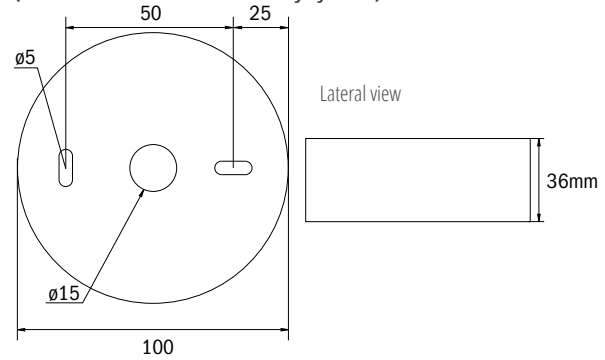

**IL-IK10**

Surface mounted die-cast housing for all ILD luminaires featuring IK 10 impact protection.



## ACCESSORIES



**IL-OEF-PC:** For easy opening of ILEx an optional opener is available.



**ILD-APA:** white Adapter plate for lateral cable feed to ILD-luminaires



**IL-IP65-K:** IP65 housing for IL ceiling luminaire (polycarbonate, white or anthrazite, chlorine resistant)



**LSYS-S:** Spotlens for luminaires with lens system. Suitable for ceilings up to 12m.



**LSYS-B:** Beam lens for luminaires with lens system. To illuminate firefighting and help points on the wall.



**ILB1/ILB2:** Square covers



**BALLPLX-ILD:** Acrylic glass ball protection for ILD luminaires







**BALLPLX-ILE:** Acrylic glass ball protection for ILD luminaires







## EMERGENCY ROUTE LIGHTING





Distance table ILDF029ML / ILEF029ML for plane emergency routes (additional distance tables on our website)

Mounting height (m)					
2.00	2.30	6.11	12.65	<b>19.27</b>	8.02
2.50	2.41	6.45	14.12	<b>22.07</b>	9.33
3.00	2.43	6.73	15.42	<b>24.50</b>	9.81
3.50	2.36	6.92	16.29	<b>26.71</b>	10.16
4.00	2.31	7.01	16.52	<b>28.14</b>	9.42





Distance table ILDS029ML / ILES029ML for plane emergency routes (additional distance tables on our website)

Mounting height (m)					
2.00	2.30	5.44	5.43	5.43	2.30
2.50	2.88	6.80	6.78	6.79	2.88
3.00	3.11	7.75	7.73	7.71	3.11
3.50	3.38	8.26	8.24	8.21	3.26
4.00	3.60	8.80	8.76	8.72	3.48
5.00	3.90	9.70	9.64	9.60	3.90
6.00	4.20	10.50	10.44	10.36	4.04
7.00	4.38	11.22	11.14	11.04	4.20
8.00	4.44	11.82	11.70	11.56	4.26
9.00	4.38	12.27	12.15	12.00	4.38
10.50	4.23	12.81	12.63	12.42	4.02
12.00	3.66	12.99	12.78	12.57	3.66

Distance table ILDH029ML / ILEH029ML for plane emergency routes (additional distance tables on our website)

Mounting height (m)					
2.00	0.39	1.16	5.55	<b>10.06</b>	4.29
2.50	0.49	1.45	6.93	<b>12.58</b>	5.36
3.00	0.58	1.74	8.32	<b>15.10</b>	6.43
3.50	0.68	2.03	9.70	<b>17.61</b>	7.51
4.00	0.78	2.32	11.09	<b>20.13</b>	8.58
5.00	0.80	2.18	12.24	<b>22.88</b>	9.40
6.00	0.84	2.24	12.96	<b>25.08</b>	9.98
7.00	0.98	2.40	13.66	<b>26.82</b>	10.78
8.00	0.98	2.60	14.16	<b>28.46</b>	11.02
9.00	1.11	2.76	14.55	<b>29.88</b>	11.52
10.50	1.11	2.85	15.03	<b>31.53</b>	12.09
12.00	1.26	3.09	15.54	<b>32.73</b>	12.42

Distance table ILDR029 im IL-IP65 Cabinet for plane emergency routes (additional distance tables on our website)

Mounting height (m)					
2.00	4.71	10.79	10.79	10.78	4.71
2.50	5.36	12.49	12.49	12.50	5.36
3.00	5.20	13.98	14.00	14.02	5.20
3.50	3.89	14.53	14.51	14.78	4.03
4.00	2.60	13.78	13.78	13.88	2.60

The distance table is based on the following parameters: Maintenance factor: 0.8; emergency lighting factor 1.00; Minimum illumination on the center line: 1.00 lux; Minimum illumination on the half width of the rescue

route: 0.50 lux, uniformity on the midline maximum 40:1; Width of the rescue route 2.00m

## EMERGENCY ROUTE LIGHTING

Distance table ILDL421SC(WB/WL) / ILEL421SC(WB/WL) and ILDL423SC(WB/WL) / ILEL423SC(WB/WL) with corridor lens for plane emergency routes (additional distance tables on our website)

Mounting height (m)					
2.00	2.49	6.66	11.01	<b>15.37</b>	6.77
2.50	2.53	6.90	12.32	<b>17.69</b>	7.81
3.00	2.50	7.10	13.55	<b>19.91</b>	8.64
3.50	2.50	7.18	14.57	<b>21.97</b>	9.34
4.00	2.46	7.14	15.36	<b>23.70</b>	9.94





Distance table ILDL421SC(WB/WL) / ILEL421SC(WB/WL) and ILDL423SC(WB/WL) / ILEL423SC(WB/WL) with spot lens for plane emergency routes (additional distance tables on our website)

Mounting height (m)					
2.00	1.77	3.97	3.97	3.97	1.77
3.00	2.46	5.60	5.60	5.60	2.46
4.00	2.97	6.67	6.67	6.67	2.97
5.00	3.37	7.79	7.79	7.79	3.37
6.00	3.73	8.68	8.68	8.68	3.73
7.00	3.97	9.49	9.49	9.49	3.97
8.00	4.09	10.24	10.24	10.24	4.09
9.00	4.11	10.83	10.83	10.83	4.11
10.00	4.04	11.26	11.26	11.26	4.04
11.00	3.87	11.53	11.53	11.53	3.87
12.00	3.59	11.65	11.65	11.65	3.59





Distance table ILDL421SC(WB/WL) / ILEL421SC(WB/WL) and ILDL423SC(WB/WL) / ILEL423SC(WB/WL) with radial lens for plane emergency routes (additional distance tables on our website)

Mounting height (m)					
2.00	3.98	8.50	8.50	8.50	3.98
2.50	4.74	10.18	10.18	10.18	4.74
3.00	5.31	11.81	11.81	11.81	5.31
3.50	5.44	13.31	13.31	13.31	5.44
4.00	1.52	11.19	11.19	11.19	1.52

Distance table ILDL428SC(WB/WL) / ILEL428SC(WB/WL) with corridor lens for plane emergency routes (additional distance tables on our website)

Mounting height (m)					
2.00	1.70	4.79	9.11	13.35	5.80
2.50	1.68	4.86	10.09	15.37	6.48
3.00	1.63	4.79	10.80	16.94	6.92
3.50	0.00	4.77	7.41	15.01	1.25
4.00	0.00	3.23	4.12	12.58	0.00

Distance table ILDL428SC(WB/WL) / ILEL428SC(WB/WL) with spot lens for plane emergency routes (additional distance tables on our website)

Mounting height (m)					
2.00	1.64	3.75	3.75	3.75	1.64
3.00	2.12	4.86	4.86	4.86	2.12
4.00	2.50	5.82	5.82	5.82	2.50
5.00	2.73	6.63	6.63	6.63	2.73
6.00	2.78	7.28	7.28	7.28	2.78
7.00	2.70	7.70	7.70	7.70	2.70
8.00	2.47	7.88	7.88	7.88	2.47
9.00	2.05	7.85	7.85	7.85	2.05
10.00	1.22	7.62	7.62	7.62	1.22
11.00	0.00	7.18	7.18	7.18	0.00

The distance table is based on the following parameters: Maintenance factor: 0.8; emergency lighting factor 1.00; Minimum illumination on the center line: 1.00 lux; Minimum illumination on the half width of the rescue

route: 0.50 lux, uniformity on the midline maximum 40:1; Width of the rescue route 2.00m



 **KMB**  
EMERGENCY ROUTE LIGHTING



GENERAL INFORMATION

## FACTS

- Plastic, white
- Universal mounting
- IP54
- SelfContained: -5° to +40°C  
Central battery: -30° to +40°C

Compact emergency luminaire for illumination of escape routes with prismatic cover for optimized light distribution. Available as luminaire for central battery systems or as a selfcontained luminaire.

The optional recessed mounting frame hides the luminaire elegantly within the ceiling.



DESIGN LUMINAIRES



DYNAMIC LUMINAIRES

UNIVERSAL LUMINAIRES

INDUSTRIAL LUMINAIRES

GENERAL LIGHTING WITH EMERGENCY LIGHT

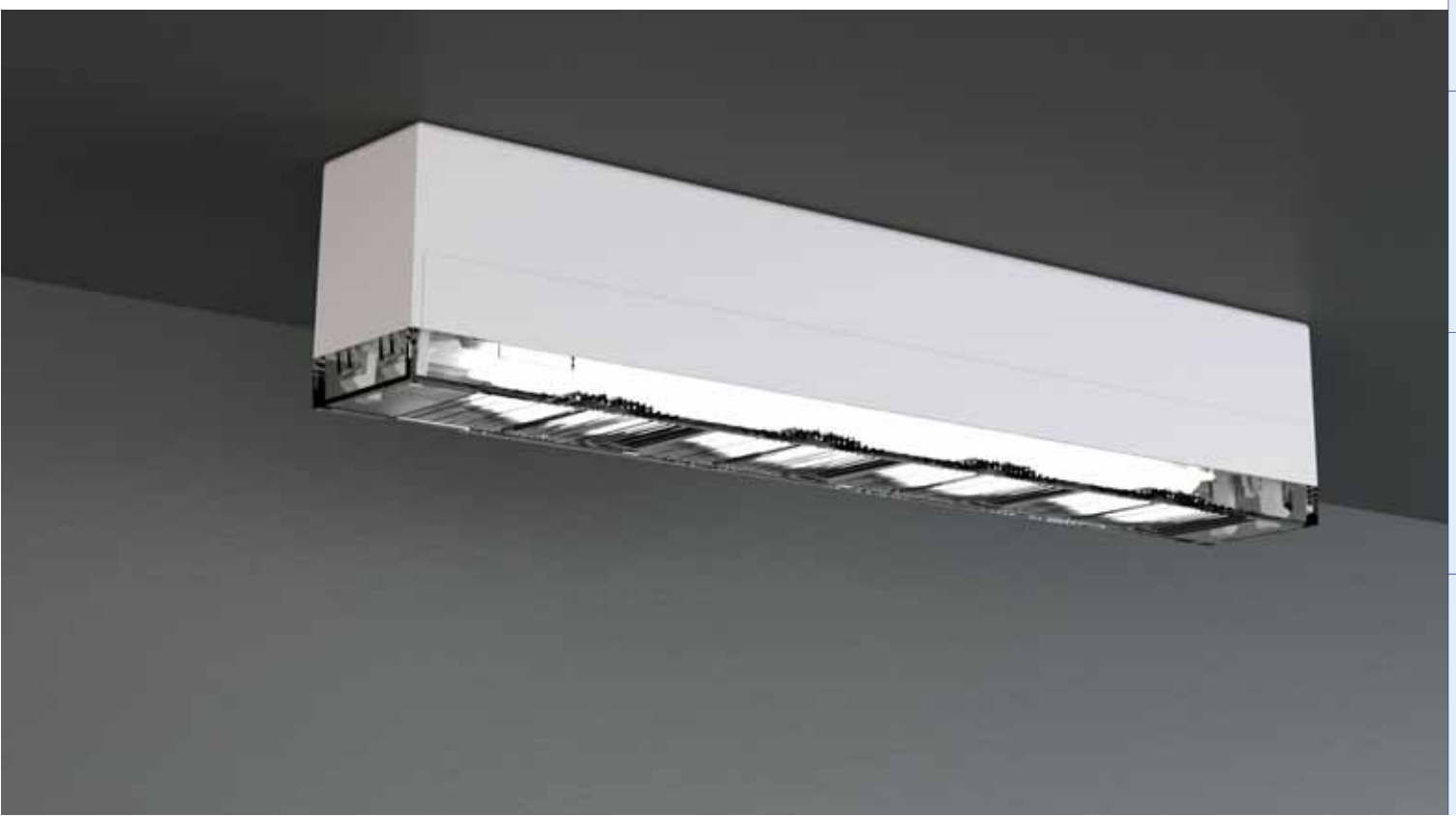

WIRELESS MONITORING

ACCESSORIES

MODULES

## EMERGENCY ROUTE LIGHTING

<b>SELF-CONTAINED LUMINAIRES WITH SELFCONTROL MODULE</b>						
LED, 1h, 230V AC	KMB011SC	KMB011SC-SW	1 h		4,6 W - 190 lm	3,2V / 3,3 Ah LiFePO4
LED, 3h, 230V AC	KMB013SC	KMB013SC-SW	3 h		4,6 W - 190 lm	3,2V / 3,3 Ah LiFePO4
LED, 8h, 230V AC	KMB018SC	KMB018SC-SW	8 h		4,6 W - 85 lm	3,2V / 3,3 Ah LiFePO4
<b>SELF-CONTAINED LUMINAIRES WITH WIRELESS BASIC MODULE</b>						
LED, 1h, 230V AC	KMB011WB	KMB011WB-SW	1 h		5,3 W - 190 lm	3,2V / 3,3 Ah LiFePO4
LED, 3h, 230V AC	KMB013WB	KMB013WB-SW	3 h		5,3 W - 190 lm	3,2V / 3,3 Ah LiFePO4
LED, 8h, 230V AC	KMB018WB	KMB018WB-SW	8 h		5,3 W - 85 lm	3,2V / 3,3 Ah LiFePO4
<b>SELF-CONTAINED LUMINAIRES WITH WIRELESS PROFESSIONAL MODULE (SWITCHABLE)</b>						
LED, 1h, 230V AC	KMB011WL	KMB011WL-SW	1 h		5,3 W - 190 lm	3,2V / 3,3 Ah LiFePO4
LED, 3h, 230V AC	KMB013WL	KMB013WL-SW	3 h		5,3 W - 190 lm	3,2V / 3,3 Ah LiFePO4
LED, 8h, 230V AC	KMB018WL	KMB018WL-SW	8 h		5,3 W - 85 lm	3,2V / 3,3 Ah LiFePO4
<b>LUMINAIRES FOR CORE COMPACT CENTRAL SYSTEMS 24V AC/DC INCL. MONITORING MODULE</b>						
LED, 24V AC/DC	KMB519CC	KMB519CC-SW	CPS		2,1 W - 220 lm	
<b>LUMINAIRES FOR CENTRAL BATTERY SYSTEMS AC/DC INCL. MONITORING MODULE</b>						
LED, 230V AC/DC	KMB019ML	KMB019ML-SW	CPS		3,2 W - 220 lm	

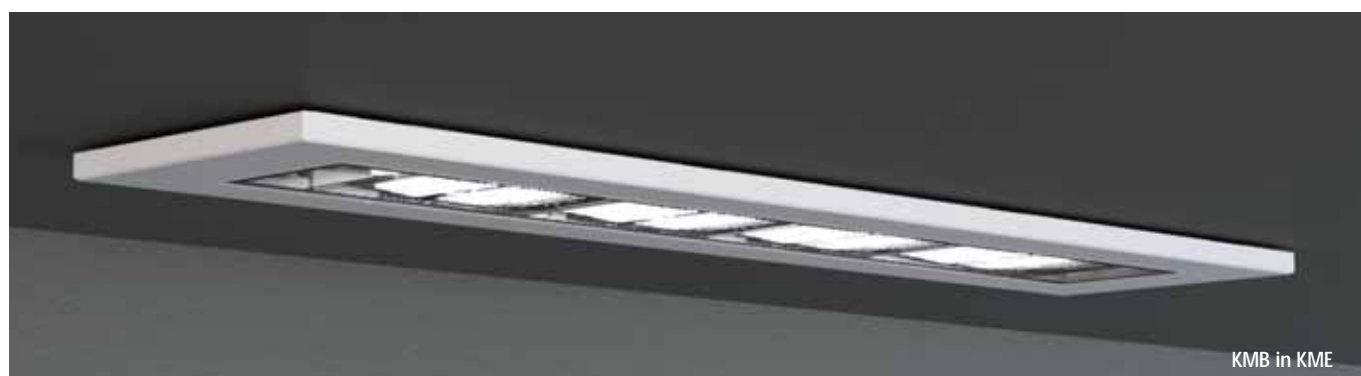

KMB in KME



Distance table KMB019ML for plane emergency routes

Mounting height (m)					
2.00	1.74	4.59	7.81	11.12	4.71
2.50	1.62	4.97	8.71	12.56	5.13
3.00	1.66	4.96	9.40	13.82	5.64
3.50	1.63	4.75	9.79	14.95	6.06
4.00	1.62	4.85	10.32	15.98	6.40

The distance table is based on the following parameters: Maintenance factor: 0.8; emergency lighting factor 1.00; Minimum illumination on the center line: 1.00 lux; Minimum illumination on the half width of the rescue

route: 0.50 lux, uniformity on the midline maximum 40:1; Width of the rescue route 2.00m

## UNIVERSAL MOUNTING

### Drilling distances KMB ceiling/wall

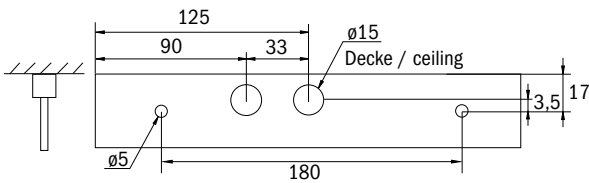

### Dimensions KMB

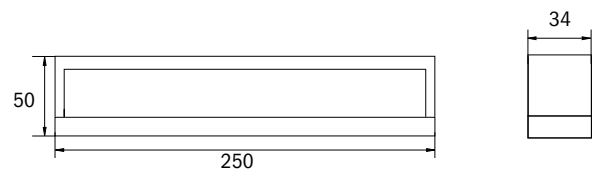

### Dimensions KME recessed frame

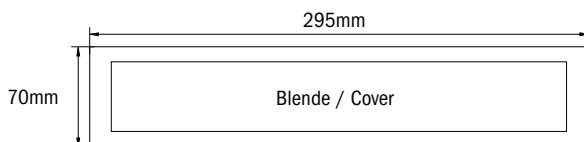

### Cut-out KME recessed frame

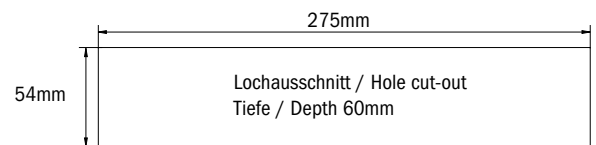

All Dimensions in mm

## ACCESSORIES

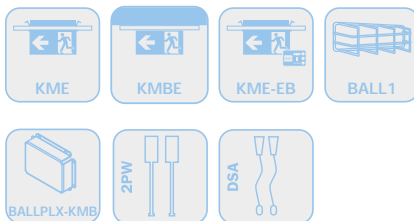

### KME Einbaurahmen

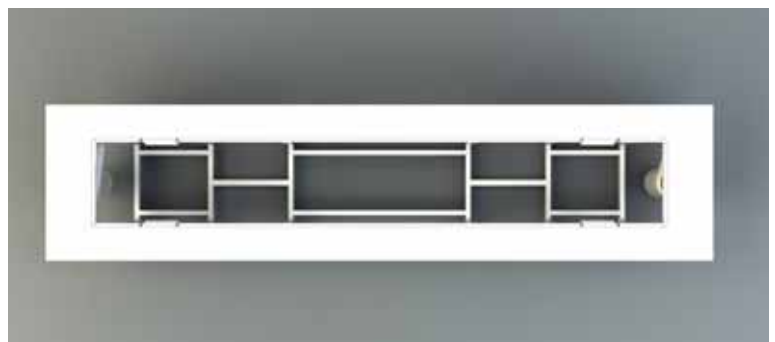



 **KE**  
EMERGENCY ROUTE LIGHTING



GENERAL INFORMATION

## FACTS

- Plastic, white
- Universal mounting
- IP40
- SelfContained: -5° to +40°C  
Central battery: -30° to +40°C

Compact plastic luminaire with ERT-LED for universal mounting for the lighting of escape and rescue routes according to DIN EN 605981, DIN EN 60598-2-22 and EN 1838.

Available for central power systems or as a self-contained luminaire. Also available as ERT luminaire with improved illumination.



DESIGN LUMINAIRES

DYNAMIC LUMINAIRES

UNIVERSAL LUMINAIRES

INDUSTRIAL LUMINAIRES

GENERAL LIGHTING WITH EMERGENCY LIGHT

WIRELESS MONITORING

ACCESSORIES





MODULES



## EMERGENCY ROUTE LIGHTING

<b>SELF-CONTAINED LUMINAIRES WITH SELFCONTROL MODULE</b>					
LED, 1h, 230V AC	KEU011SC	1 h	6,1 W - 300 lm	4,8V/2,0Ah NiMH	
LED, 1h, 230V AC	KEU021SC	1 h	6 W - 520 lm	4,8V/2,0Ah NiMH	
LED, 3h, 230V AC	KEU013SC	3 h	6,1 W - 150 lm	4,8V/2,0Ah NiMH	
LED, 3h, 230V AC	KEU023SC	3 h	7,1 W - 520 lm	9,6V/2,0Ah NiMH	
LED, 8h, 230V AC	KEU018SC	8 h	7,1 W - 220 lm	9,6V/2,0Ah NiMH	
<b>SELF-CONTAINED LUMINAIRES WITH WIRELESS PROFESSIONAL MODUL (NOT SWITCHABLE)</b>					
LED, 1h, 230V AC	KEU011WL	1 h	7,5 W - 150 lm	12V/0,8Ah NiMH	
LED, 3h, 230V AC	KEU013WL	3 h	7,5 W - 150 lm	12V/0,8Ah NiMH	
LED, 8h, 230V AC	KEU018WL	8 h	7,5 W - 60 lm	12V/0,8Ah NiMH	
<b>LUMINAIRES FOR CENTRAL BATTERY SYSTEMS AC/DC</b>					
LED, 230V AC/DC	KEU019	CPS	4,5 W - 300 lm		
LED, 230V AC/DC	KEU029	CPS	4,6 W - 520 lm		
<b>LUMINAIRES FOR CENTRAL BATTERY SYSTEMS AC/DC INCL. MONITORING MODULE</b>					
LED, 230V AC/DC	KEU019ML	CPS	5,2 W - 300 lm		
LED, 230V AC/DC	KEU029ML	CPS	5,2 W - 520 lm		

### Distance table KEU029 for plane emergency routes

Mounting height (m)					
2.00	8.02	20.31	17.19	7.16	2.86
2.50	9.33	22.81	19.10	7.86	3.09
3.00	9.81	24.91	20.52	8.38	3.22
3.50	10.16	26.78	21.59	8.79	3.26
4.00	10.42	28.26	22.14	9.09	3.36

The distance table is based on the following parameters: Maintenance factor: 0.8; emergency lighting factor 1.00; Minimum illumination on the center line: 1.00 lux; Minimum illumination on the half width of the rescue

route: 0.50 lux, uniformity on the midline maximum 40:1; Width of the rescue route 2.00m

## UNIVERSAL MOUNTING

### Dimensions KE wall/ceiling

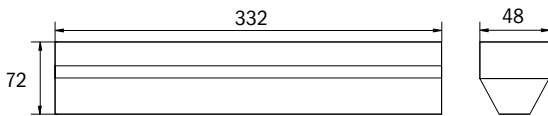

### Drilling distances KE wall/ceiling

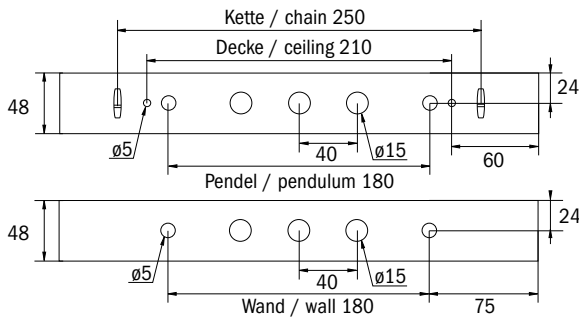

All Dimensions in mm

### Cut-out KE recessed frame

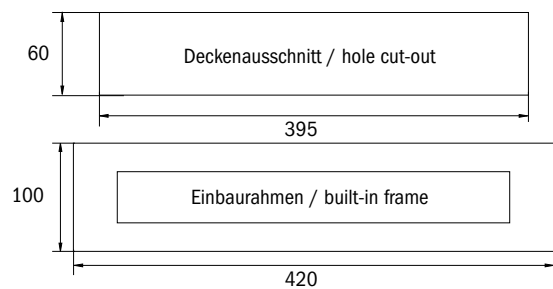

## ACCESSORIES

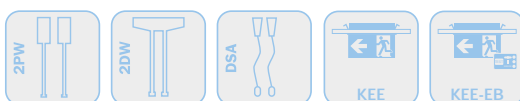



 **DO**  
EMERGENCY ROUTE LIGHTING



GENERAL INFORMATION

## FACTS

- Plastic, transparent
- Optional for application in third party luminaires
- IP20
- SelfContained: -5° to +40°C  
Central battery: -30° to +40°C

Compact Emergency lighting unit with oval lighting ERT-LED luminaire for the lighting of escape and rescue routes according to DIN EN 60598-1, DIN EN 60598-2-22 and EN 1838. For recessed mounting or snap-on mounting on T5/T8 illuminants and metal objects.

Transparent body material makes the luminaire a perfect match in any setting. Available with electronics box or as bulk version for application in existing luminaire cases. Dowel and clips included.



DESIGN LUMINAIRES

DYNAMIC LUMINAIRES

UNIVERSAL LUMINAIRES

INDUSTRIAL LUMINAIRES

GENERAL LIGHTING WITH EMERGENCY LIGHT

WIRELESS MONITORING





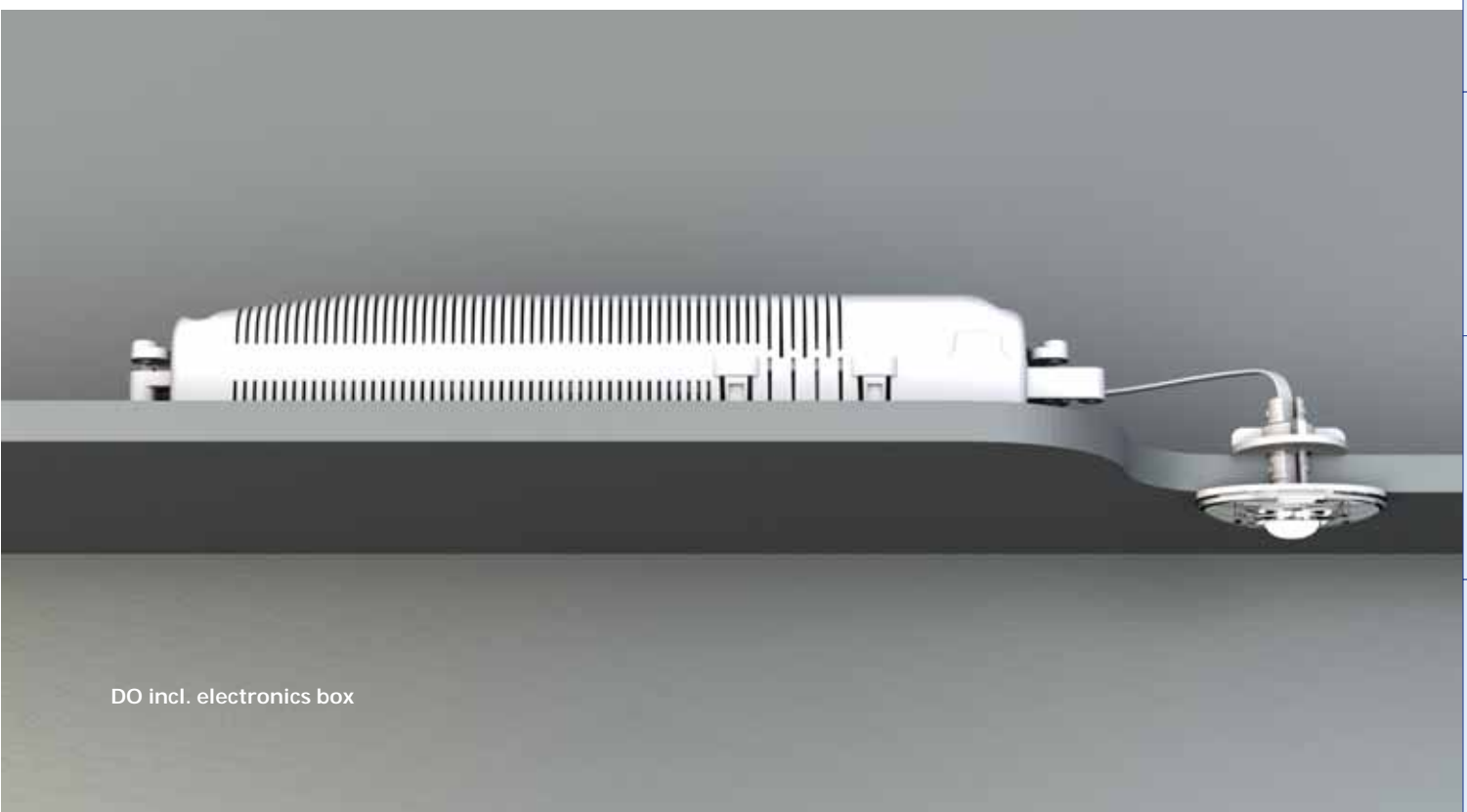





ACCESSORIES

MODULES







DO incl. electronics box

## EMERGENCY ROUTE LIGHTING

	bulk, for mounting in existing luminaires	incl. housing				
<b>SELF-CONTAINED LUMINAIRES WITH SELFCONTROL MODULE</b>						
LED, 1h, 230V AC	DOS021SC	DOE021SC	1 h	3 W - 140 lm	4,8V/2,0Ah NiMH	
LED, 3h, 230V AC	DOS023SC	DOE023SC	3 h	3 W - 140 lm	4,8V/2,0Ah NiMH	
LED, 8h, 230V AC	DOS028SC	DOE028SC	8 h	4,4 W - 140 lm	9,6V/2,0Ah NiMH	
<b>SELF-CONTAINED LUMINAIRES WITH WIRELESS PROFESSIONAL MODULE (SWITCHABLE)</b>						
LED, 1h, 230V AC	DOS021WL	DOE021WL	1 h	5,6 W - 140 lm	4,8V/2,0Ah NiMH	
LED, 3h, 230V AC	DOS023WL	DOE023WL	3 h	5,6 W - 140 lm	4,8V/2,0Ah NiMH	
<b>LUMINAIRES FOR CENTRAL BATTERY SYSTEMS AC/DC</b>						
LED, 230V AC/DC	DOS029	DOE029	CPS	1,9 W - 140 lm		
<b>LUMINAIRES FOR CENTRAL BATTERY SYSTEMS AC/DC INCL. MONITORING MODULE</b>						
LED, 230V AC/DC	DOS029ML	DOE029ML	CPS	2,8 W - 140 lm		



Distance table DO 023 / DO 029 ERT-LED for plane emergency routes

Mounting height (m)					
2.00	1.51	3.74	7.22	10.83	4.71
2.50	1.62	4.16	8.30	12.62	5.36
3.00	1.73	4.49	9.14	14.14	5.64
3.50	1.71	4.74	9.65	15.34	5.60
4.00	1.54	4.89	9.32	16.14	4.44

The distance table is based on the following parameters: Maintenance factor: 0.8; emergency lighting factor 1.00; Minimum illumination on the center line: 1.00 lux; Minimum illumination on the half width of the rescue

route: 0.50 lux, uniformity on the midline maximum 40:1; Width of the rescue route 2.00m

## CEILING MOUNTING

Dimensions DOE023 / 029

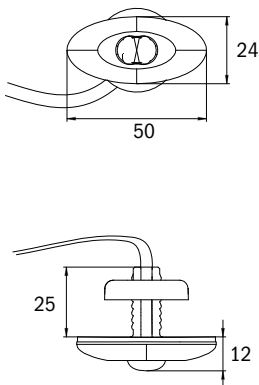

Electronics box



Cut-out electronics box

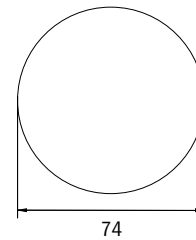

Cut-out DO



All Dimensions in mm

Für Betoneinbau empfehlen wir die Dosen HaloX-0 + HaloX-40 der Firma Kaiser.



# INDUSTRIAL LUMINAIRES





 **PM**  
POLYCARBONATE LUMINAIRE



## FACTS

- Polycarbonate, white
- 20m Viewing distance
- Complete set of pictographs (ISO 7010)
- IP65; Insulation class II
- Wall or ceiling mounting
- Self-contained: -5° to +40°C  
Central battery: -30° to +40°C



The smaller version of the well-proven KCW light can be used as an escape sign light or as an emergency light and, thanks to its low installation height, is particularly suitable for use in underground car parks.

The mounting tray can be used with both a flat and a high hood.

<b>SELF-CONTAINED LUMINAIRES WITH SELFCONTROL MODULE</b>						
LED, 1h, 230V AC	PMW001SC	PMD001SC	1 h	4,2 W	4,8V/2,0Ah NiMH	
LED, 3h, 230V AC	PMW003SC	PMD003SC	3 h	4,2 W	4,8V/2,0Ah NiMH	
LED, 8h, 230V AC	PMW008SC	PMD008SC	8 h	5,3 W	9,6V/2,0Ah NiMH	
LED, 1h, 230V AC	PMW021SC		1 h	4,5 W - 260 lm	4,8V/2,0Ah NiMH	
LED, 3h, 230V AC	PMW023SC		3 h	7,1 W - 520 lm	9,6V/2,0Ah NiMH	
LED, 8h, 230V AC	PMW028SC		8 h	7,1 W - 220 lm	9,6V/2,0Ah NiMH	
<b>LUMINAIRES FOR CENTRAL BATTERY SYSTEMS AC/DC INCL. MONITORING MODULE</b>						
LED, 230V AC/DC	PMW009ML	PMD009ML	CPS	3,6 W		
LED, 230V AC/DC	PMW029ML		CPS	5,2 W - 520 lm		
LED, 230V AC/DC	PMW039ML		CPS	9,4 W - 1050 lm		

## WALL MOUNTING

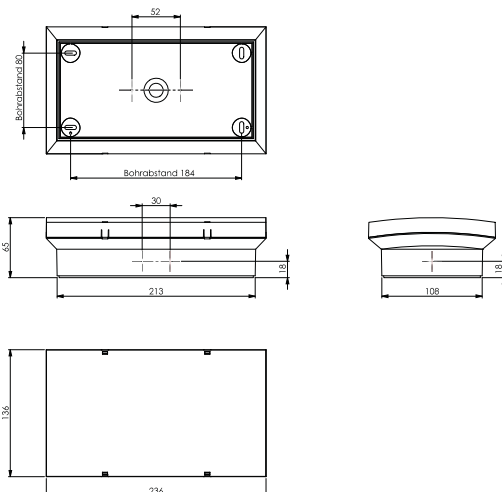

## CEILING MOUNTING

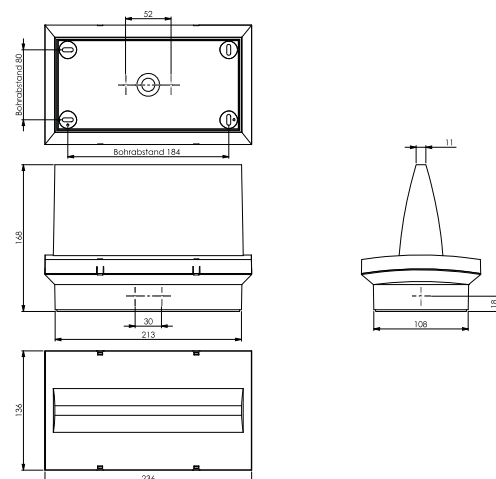





## FACTS

- Plastic, white
- 30m Viewing distance
- Complete set of pictographs (ISO 7010)
- KCW: IP54, optional IP64
- KCD: IP40
- Wall or ceiling mounting
- SelfContained: -5° to +40°C
- Central battery: -30° to +40°C

Convex exit sign made of plastic for wall or ceiling mounting. Sign with pluggable, solvent free, internally mounted pictograph. Pictogram set included.

This luminaire can be used without pictogram as an emergency lighting luminaire with a clear cover.

Escape route/Exit sign/ emergency luminaire according to EN 60598-1, EN 60598-2-22 and EN 1838 norms.



KCW

GENERAL INFORMATION

DESIGN LUMINAIRES

DYNAMIC LUMINAIRES

UNIVERSAL LUMINAIRES

INDUSTRIAL LUMINAIRES

GENERAL LIGHTING WITH EMERGENCY LIGHT

WIRELESS MONITORING

ACCESSORIES

MODULES

## PLASTIC LUMINAIRE

KCW



<b>SELF-CONTAINED LUMINAIRES WITH SELFCONTROL MODULE</b>						
LED, 1h, 230V AC	KCW021SC **	KCW021SC-COOLIP54 *	1 h	6 W - 520 lm	4,8V/2,0Ah NiMH	
LED, 1h, 230V AC	KCW011SC **	KCW011SC-COOLIP54 *	1 h	6,1 W - 300 lm	4,8V/2,0Ah NiMH	
LED, 3h, 230V AC	KCW013SC **	KCW013SC-COOLIP54 *	3 h	6,1 W - 150 lm	4,8V/2,0Ah NiMH	
LED, 3h, 230V AC	KCW023SC **	KCW023SC-COOLIP54 *	3 h	7,1 W - 520 lm	9,6V/2,0Ah NiMH	
LED, 8h, 230V AC	KCW018SC **	KCW018SC-COOLIP54 *	8 h	6,7 W - 160 lm	9,6V/2,0Ah NiMH	
LED, 8h, 230V AC	KCW028SC **		8 h	7,1 W - 220 lm	9,6V/2,0Ah NiMH	
<b>SELF-CONTAINED LUMINAIRES WITH WIRELESS PROFESSIONAL MODUL (NOT SWITCHABLE)</b>						
LED, 1h, 230V AC	KCW011WL (SE) **	KCW011WL-COOLIP54 *	1 h	7,5 W - 150 lm	12V/0,8Ah NiMH	
LED, 3h, 230V AC	KCW013WL (SE) **	KCW013WL-COOLIP54 *	3 h	7,5 W - 150 lm	12V/0,8Ah NiMH	
LED, 8h, 230V AC	KCW018WL (SE) **	KCW018WL-COOLIP54 *	8 h	7,5 W - 60 lm	12V/0,8Ah NiMH	
<b>LUMINAIRES FOR CORE COMPACT CENTRAL SYSTEMS 24V AC/DC INCL. MONITORING MODULE</b>						
LED, 24V AC/DC	KCW519CC		CPS	3,8 W - 335 lm		
LED, 24V AC/DC	KCW529CC		CPS	3,8 W - 520 lm		
<b>LUMINAIRES FOR CENTRAL BATTERY SYSTEMS AC/DC</b>						
LED, 230V AC/DC	KCW019		CPS	4,5 W - 300 lm		
LED, 230V AC/DC	KCW029		CPS	4,6 W - 520 lm		
<b>LUMINAIRES FOR CENTRAL BATTERY SYSTEMS AC/DC INCL. MONITORING MODULE</b>						
LED, 230V AC/DC	KCW029ML		CPS	5,2 W - 520 lm		
LED, 230V AC/DC	KCW019ML		CPS	5,2 W - 300 lm		

\*) All versions also available as COOL-luminaires with external battery housing in IP20 for mounting within the building. The luminaire may be mounted outside or in cool stores.

\*\*) Optional -EHE: with electronic heating element for use of the luminaire at temperatures low to - 15°C



(SE) Luminaires are switchable by radio with the optional switching extension with the Wireless Professional system.



## KCW WALL-/ CEILING MOUNTING

### Dimensions KC wall

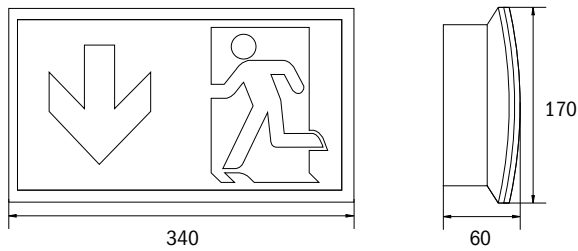

### Drilling distances KC

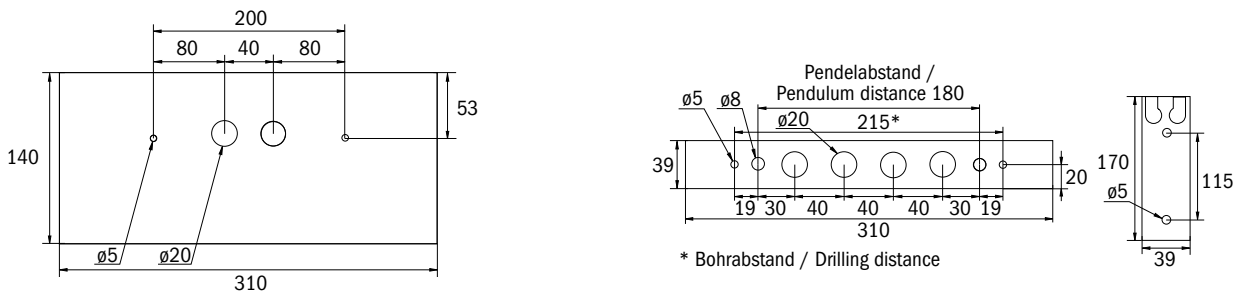

### External electronics housing -COOL IP54

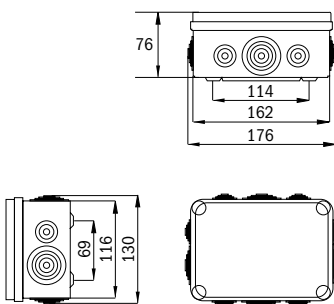

IP54

All Dimensions in mm

### Rain cover KCRD for KCW (with IP65 Option only)

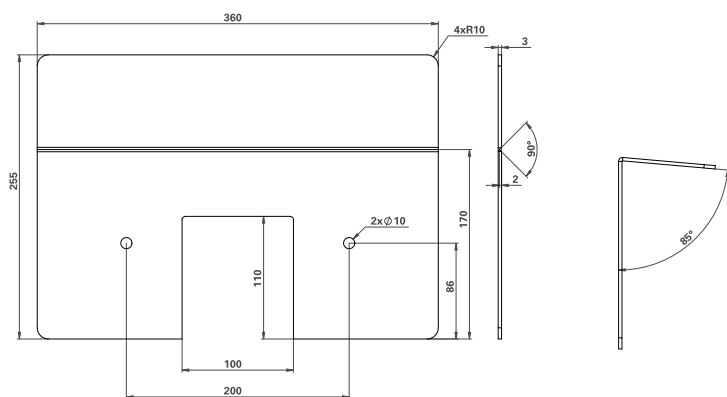

### Distance table KCW029 for plane emergency routes

Mounting height (m)					
2.00	7.46	16.44	15.49	8.50	3.33
2.50	8.72	19.75	18.20	9.18	3.44
3.00	9.81	22.80	20.34	9.57	3.45
3.50	10.77	25.37	22.28	9.86	3.50
4.00	10.99	27.55	22.99	9.84	3.48

The distance table is based on the following parameters: Maintenance factor: 0.8; emergency lighting factor 1.00; Minimum illumination on the center line: 1.00 lux; Minimum illumination on the half width of the rescue

route: 0.50 lux, uniformity on the midline maximum 40:1; Width of the rescue route 2.00m

## PLASTIC LUMINAIRE

KCD

IP40

IP64  
optional

<b>SELF-CONTAINED LUMINAIRES WITH SELFCONTROL MODULE</b>					
LED, 1h, 230V AC	KCD011SC	1 h	6,1 W - 300 lm	4,8V/2,0Ah NiMH	
LED, 3h, 230V AC	KCD013SC	3 h	6,1 W - 150 lm	4,8V/2,0Ah NiMH	
LED, 8h, 230V AC	KCD018SC	8 h	6,7 W - 160 lm	9,6V/2,0Ah NiMH	
<b>SELF-CONTAINED LUMINAIRES WITH WIRELESS PROFESSIONAL MODUL (NOT SWITCHABLE)</b>					
LED, 1h, 230V AC	KCD011WL	1 h	7,5 W - 150 lm	12V/0,8Ah NiMH	
LED, 3h, 230V AC	KCD013WL	3 h	7,5 W - 150 lm	12V/0,8Ah NiMH	
LED, 8h, 230V AC	KCD018WL	8 h	7,5 W - 60 lm	12V/0,8Ah NiMH	
<b>LUMINAIRES FOR CORE COMPACT CENTRAL SYSTEMS 24V AC/DC INCL. MONITORING MODULE</b>					
LED, 24V AC/DC	KCD519CC	CPS	3,8 W - 335 lm		
<b>LUMINAIRES FOR CENTRAL BATTERY SYSTEMS AC/DC</b>					
LED, 230V AC/DC	KCD019	CPS	4,5 W - 300 lm		
LED, 230V AC/DC	KCD029	CPS	4,6 W - 520 lm		
<b>LUMINAIRES FOR CENTRAL BATTERY SYSTEMS AC/DC INCL. MONITORING MODULE</b>					
LED, 230V AC/DC	KCD019ML	CPS	5,2 W - 300 lm		
LED, 230V AC/DC	KCD029ML	CPS	5,2 W - 520 lm		

## KCD CEILING MOUNTING

Dimensions KC ceiling

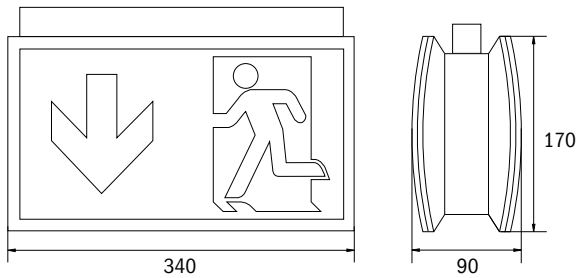

Drilling distances KC

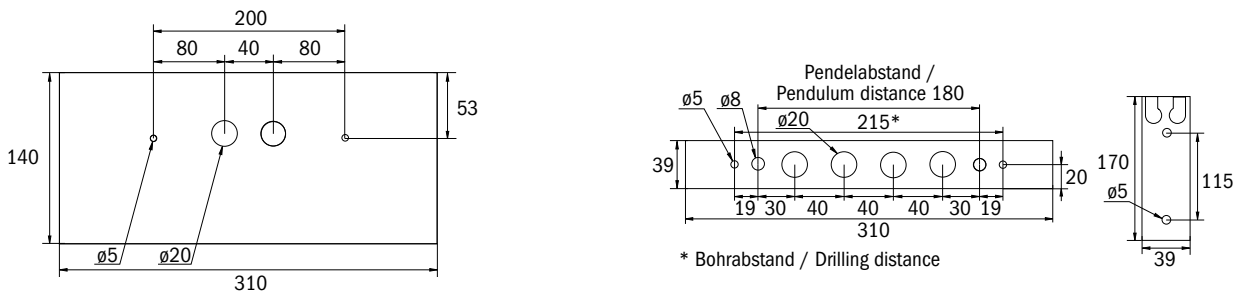

All Dimensions in mm

## ACCESSORIES

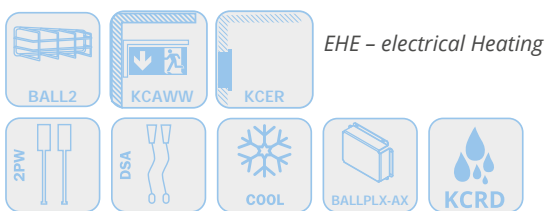



 **KD / KL**  
PLASTIC LUMINAIRE



## FACTS

- Plastic, white
- 22m (KD) or 34m (KL) Viewing distance
- Complete set of pictographs (ISO 7010)
- IP43
- Universal mounting incl. wall bracket
- SelfContained: -5° to +40°C  
Central battery: -30° to +40°C

Slim design plastic luminaire for universal mounting (wall/ ceiling or as wall bracket with supplied adapter).













This luminaire provides additional downward lighting to enhance safety at the egress route. Applicable for maintained or non-maintained operation mode.

Improved reliability through easy to install universal use of pictograms. Signs according to EN 60598-1, EN 60598-2-22 and EN 1838 norms.



## PLASTIC LUMINAIRE

### KD (22M)

	 universal				
<b>SELF-CONTAINED LUMINAIRES WITH SELFCONTROL MODULE</b>					
LED, 1h, 230V AC	KDU011SC	1 h	6,1 W	4,8V/2,0Ah NiMH	
LED, 3h, 230V AC	KDU013SC	3 h	6,1 W	4,8V/2,0Ah NiMH	
LED, 8h, 230V AC	KDU018SC	8 h	6,7 W	9,6V/2,0Ah NiMH	
<b>SELF-CONTAINED LUMINAIRES WITH WIRELESS PROFESSIONAL MODUL (NOT SWITCHABLE)</b>					
LED, 1h, 230V AC	KDU011WL	1 h	7,5 W	12V/0,8Ah NiMH	
LED, 3h, 230V AC	KDU013WL	3 h	7,5 W	12V/0,8Ah NiMH	
LED, 8h, 230V AC	KDU018WL	8 h	7,5 W	12V/0,8Ah NiMH	
<b>LUMINAIRES FOR CORE COMPACT CENTRAL SYSTEMS 24V AC/DC INCL. MONITORING MODULE</b>					
LED, 24V AC/DC	KDU519CC	CPS	3,6 W		
<b>LUMINAIRES FOR CENTRAL BATTERY SYSTEMS AC/DC</b>					
LED, 230V AC/DC	KDU019	CPS	4,5 W		
<b>LUMINAIRES FOR CENTRAL BATTERY SYSTEMS AC/DC INCL. MONITORING MODULE</b>					
LED, 230V AC/DC	KDU019ML	CPS	5,2 W		

## UNIVERSAL MOUNTING

Dimensions KD wall

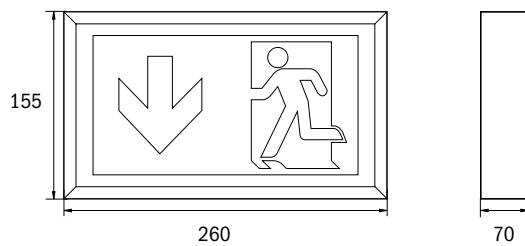

Dimensions KD ceiling

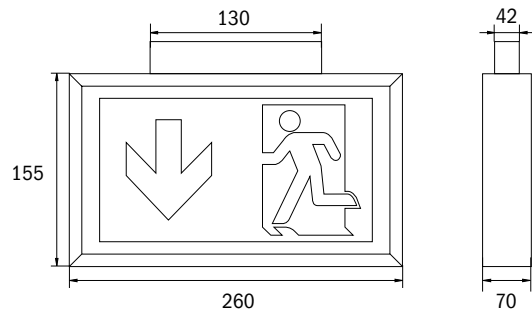

Drilling distances KD wall

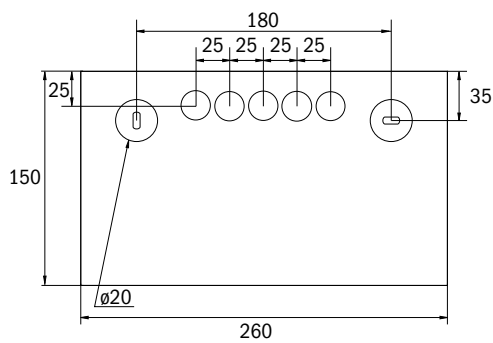

Drilling distances KD ceiling

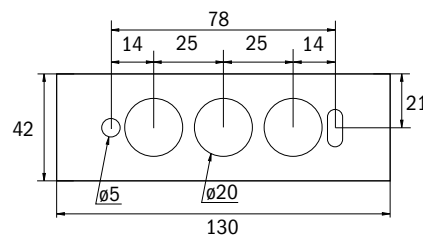













All Dimensions in mm

## ACCESSORIES



## PLASTIC LUMINAIRE

### KL (34M)

	 universal				
<b>SELF-CONTAINED LUMINAIRES WITH SELFCONTROL MODULE</b>					
LED, 1h, 230V AC	KLU011SC	1 h	6,1 W	4,8V/2,0Ah NiMH	
LED, 3h, 230V AC	KLU013SC	3 h	6,1 W	4,8V/2,0Ah NiMH	
LED, 8h, 230V AC	KLU018SC	8 h	6,7 W	9,6V/2,0Ah NiMH	
<b>SELF-CONTAINED LUMINAIRES WITH WIRELESS PROFESSIONAL MODUL (NOT SWITCHABLE)</b>					
LED, 1h, 230V AC	KLU011WL	1 h	7,5 W	12V/0,8Ah NiMH	
LED, 3h, 230V AC	KLU013WL	3 h	7,5 W	12V/0,8Ah NiMH	
LED, 8h, 230V AC	KLU018WL	8 h	7,5 W	12V/0,8Ah NiMH	
<b>LUMINAIRES FOR CORE COMPACT CENTRAL SYSTEMS 24V AC/DC INCL. MONITORING MODULE</b>					
LED, 24V AC/DC	KLU519CC	CPS	3,6 W		
<b>LUMINAIRES FOR CENTRAL BATTERY SYSTEMS AC/DC</b>					
LED, 230V AC/DC	KLU019	CPS	4,5 W		
<b>LUMINAIRES FOR CENTRAL BATTERY SYSTEMS AC/DC INCL. MONITORING MODULE</b>					
LED, 230V AC/DC	KLU019ML	CPS	5,2 W		



## UNIVERSAL MOUNTING

Dimensions KL wall

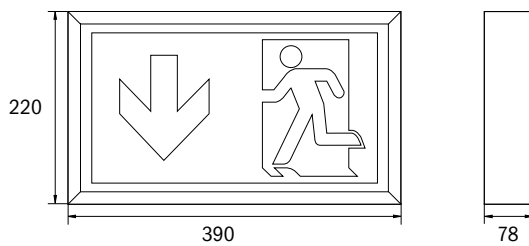

Drilling distances KL wall

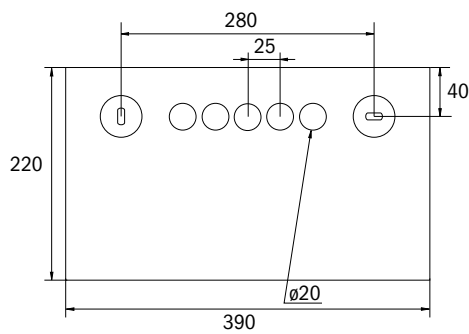

All Dimensions in mm

Dimensions KL ceiling

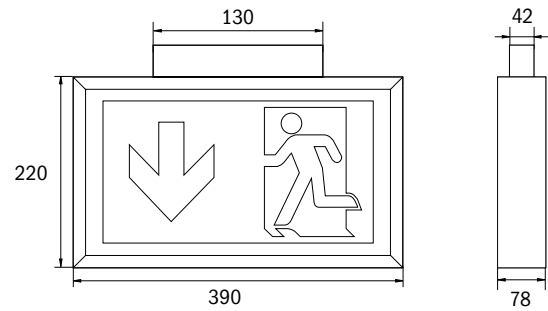

Drilling distances KL ceiling

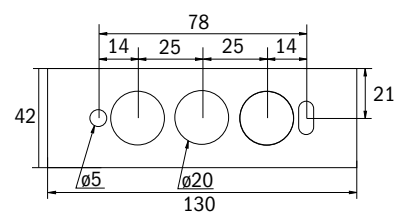

## ACCESSORIES

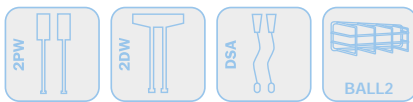

When mounting with cord suspension or pendulum the protection class is reduced to IP20.



 **LM / LX / LS**  
ALUMINIUM PROFILED LUMINAIRES



## FACTS

- Aluminium housing
- 22m (LM), 34m (LX) or 56m (LS) viewing distance
- Complete set of pictographs (ISO 7010) - not for LS
- IP40
- Available for wall or ceiling mounting
- SelfContained: -5° to +40°C  
Central battery: -30° to +40°C

Luminare designed in slender aluminum profile, matte anodized, finishing for ceiling mounting with additional downward lighting, enhancing safety. Toolless mounting chassis. Applicable for maintained or non-maintained operation mode.

Improved reliability through easy to install universal use of pictograms. Pictogram set (left, right, up, down signs) included (not for LS). Signs according to EN 60598-1, EN 60598-2-22 and EN 1838 norms.



DESIGN LUMINAIRES



DYNAMIC LUMINAIRES

UNIVERSAL LUMINAIRES

INDUSTRIAL LUMINAIRES

GENERAL LIGHTING WITH EMERGENCY LIGHT















WIRELESS MONITORING

ACCESSORIES

MODULES

## ALUMINIUM PROFILED LUMINAIRES

### LM (22m)

						
<b>SELF-CONTAINED LUMINAIRES WITH SELFCONTROL MODULE</b>						
LED, 1h, 230V AC	LMD011SC	LMW011SC	1 h	6,1 W	4,8V/2,0Ah NiMH	
LED, 3h, 230V AC	LMD013SC	LMW013SC	3 h	6,1 W	4,8V/2,0Ah NiMH	
LED, 8h, 230V AC	LMD018SC	LMW018SC	8 h	6,7 W	9,6V/2,0Ah NiMH	
<b>SELF-CONTAINED LUMINAIRES WITH WIRELESS PROFESSIONAL MODUL (NOT SWITCHABLE)</b>						
LED, 1h, 230V AC	LMD011WL	LMW011WL	1 h	7,5 W	12V/0,8Ah NiMH	
LED, 3h, 230V AC	LMD013WL	LMW013WL	3 h	7,5 W	12V/0,8Ah NiMH	
LED, 8h, 230V AC	LMD018WL	LMW018WL	8 h	7,5 W	12V/0,8Ah NiMH	
<b>LUMINAIRES FOR CENTRAL BATTERY SYSTEMS AC/DC</b>						
LED, 230V AC/DC	LMD019	LMW019	CPS	4,5 W		
<b>LUMINAIRES FOR CENTRAL BATTERY SYSTEMS AC/DC INCL. MONITORING MODULE</b>						
LED, 230V AC/DC	LMD019ML	LMW019ML	CPS	5,2 W		

### CEILING MOUNTING

Dimensions LM ceiling

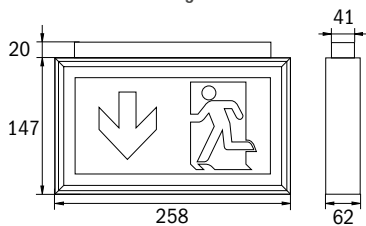

### WALL MOUNTING

Dimensions LM wall

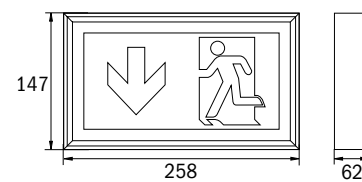

All Dimensions in mm

### ACCESSORIES





## LX (34m)

<b>SELF-CONTAINED LUMINAIRES WITH SELFCONTROL MODULE</b>						
LED, 1h, 230V AC	LXD011SC	LXW011SC	1 h	6,1 W	4,8V/2,0Ah NiMH	
LED, 3h, 230V AC	LXD013SC	LXW013SC	3 h	6,1 W	4,8V/2,0Ah NiMH	
LED, 8h, 230V AC	LXD018SC	LXW018SC	8 h	6,7 W	9,6V/2,0Ah NiMH	
<b>SELF-CONTAINED LUMINAIRES WITH WIRELESS PROFESSIONAL MODUL (NOT SWITCHABLE)</b>						
LED, 1h, 230V AC	LXD011WL	LXW011WL	1 h	7,5 W	12V/0,8Ah NiMH	
LED, 3h, 230V AC	LXD013WL	LXW013WL	3 h	7,5 W	12V/0,8Ah NiMH	
<b>LUMINAIRES FOR CENTRAL BATTERY SYSTEMS AC/DC</b>						
LED, 230V AC/DC	LXD019	LXW019	CPS	4,5 W		
<b>LUMINAIRES FOR CENTRAL BATTERY SYSTEMS AC/DC INCL. MONITORING MODULE</b>						
LED, 230V AC/DC	LXD019ML	LXW019ML	CPS	5,2 W		

## CEILING MOUNTING

Dimensions LX ceiling

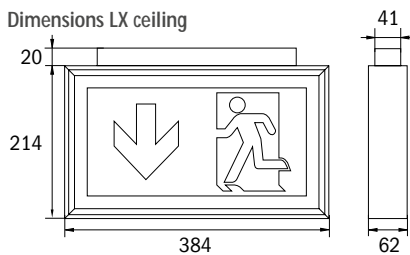

## WALL MOUNTING

Dimensions LX wall

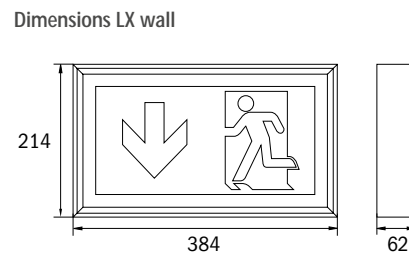





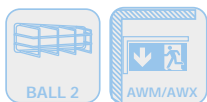





All Dimensions in mm

## ACCESSORIES



## ALUMINIUM PROFILED LUMINAIRES

LS (56M) – NO PICTOGRAPH SET INCLUDED; PLEASE SPECIFY PICTOGRAPH

						
<b>SELF-CONTAINED LUMINAIRES WITH SELFCONTROL MODULE</b>						
LED, 1h, 230V AC	LSD011SC		1 h	6,1 W	9,6V/2,0Ah NiMH	
LED, 3h, 230V AC	LSD013SC	LSW013SC	3 h	6,5 W	9,6V/2,0Ah NiMH	
<b>SELF-CONTAINED LUMINAIRES WITH WIRELESS PROFESSIONAL MODUL (NOT SWITCHABLE)</b>						
LED, 1h, 230V AC	LSD011WL	LSW011WL	1 h	7,5 W	12V/0,8Ah NiMH	
<b>LUMINAIRES FOR CENTRAL BATTERY SYSTEMS AC/DC</b>						
LED, 230V AC/DC	LSD019	LSW019	CPS	8,3 W		
<b>LUMINAIRES FOR CENTRAL BATTERY SYSTEMS AC/DC INCL. MONITORING MODULE</b>						
LED, 230V AC/DC	LSD019ML	LSW019ML	CPS	9,3 W		

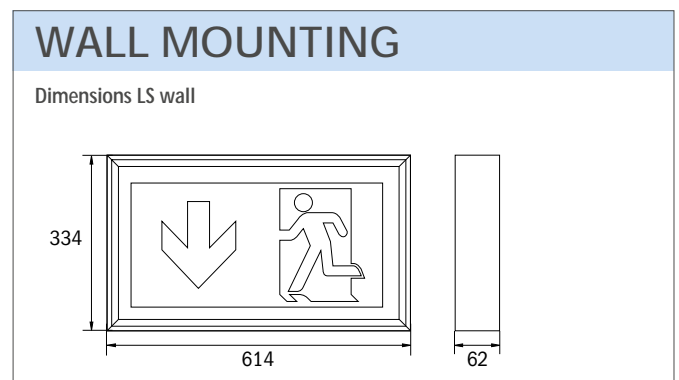
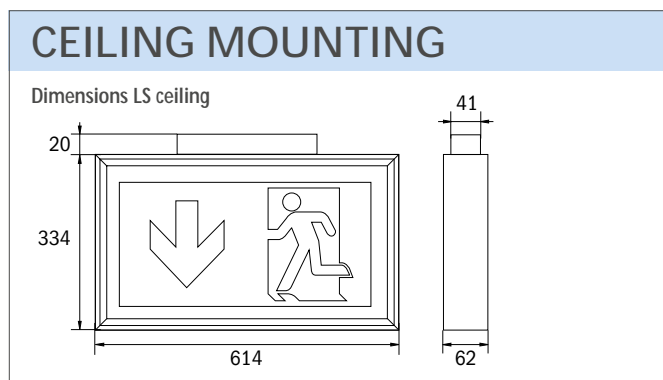

All Dimensions in mm

### ACCESSORIES



BALL4



IP40



inclusive

22/34/56m

MODULES

ACCESSORIES

WIRELESS MONITORING

GENERAL LIGHTING  
WITH EMERGENCY LIGHT

INDUSTRIAL  
LUMINAIRES

UNIVERSAL  
LUMINAIRES

DYNAMIC  
LUMINAIRES

DESIGN LUMINAIRES

GENERAL  
INFORMATIONS





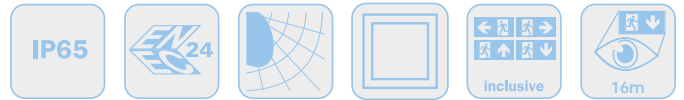

GENERAL INFORMATION

## FACTS

- Plastic, white
- Complete set of pictographs (ISO 7010)
- IP65
- Available for wall or ceiling mounting
- SelfContained: -5° to +40°C  
Central battery: -30° to +40°C



DESIGN LUMINAIRES

DYNAMIC LUMINAIRES

UNIVERSAL LUMINAIRES

Exit sign / escape route light according to DIN EN 60598-1, DIN EN 60598-2-22 and DIN EN 1838

Classic bar-shaped polycarbonate luminaire for ceiling mounting. Straight lines as well as the robust construction allow versatile use.

Suitable for permanent or standby switching. Planning security through tool-free, variable use of the pictographs on site. Pictograms according to DIN EN ISO 7010 and DIN ISO 3864 (left, right, above, below) are included as standard in the scope of delivery.

INDUSTRIAL LUMINAIRES

GENERAL LIGHTING WITH EMERGENCY LIGHT



WIRELESS MONITORING

ACCESSORIES

MODULES

## PLASTIC LUMINAIRE

<b>SELF-CONTAINED LUMINAIRES WITH SELFCONTROL MODULE</b>						
LED, 1h, 230V AC		KWIW021SC	1 h	6 W - 520 lm	4,8V/2,0Ah NiMH	
LED, 1h, 230V AC	KWID011SC	KWIW011SC	1 h	6,2 W	4,8V/2,0Ah NiMH	
LED, 3h, 230V AC	KWID013SC	KWIW013SC	3 h	6,17 W	4,8V/2,0Ah NiMH	
LED, 3h, 230V AC		KWIW023SC	3 h	7,1 W - 520 lm	9,6V/2,0Ah NiMH	
LED, 8h, 230V AC	KWID018SC	KWIW018SC	8 h	7 W	9,6V/2,0Ah NiMH	
<b>LUMINAIRES FOR CORE COMPACT CENTRAL SYSTEMS 24V AC/DC INCL. MONITORING MODULE</b>						
LED, 24V AC/DC	KWID519CC	KWIW519CC	CPS	3,8 W - 335 lm		
LED, 24V AC/DC	KWID529CC	KWIW529CC	CPS	3,8 W - 520 lm		
<b>LUMINAIRES FOR CENTRAL BATTERY SYSTEMS AC/DC</b>						
LED, 230V AC/DC		KWIW029	CPS	4,6 W - 520 lm		
<b>LUMINAIRES FOR CENTRAL BATTERY SYSTEMS AC/DC INCL. MONITORING MODULE</b>						
LED, 230V AC/DC		KWIW029ML	CPS	5,2 W - 520 lm		
LED, 230V AC/DC	KWID019ML	KWIW019ML	CPS	5,2 W		
LED, 230V AC/DC		KWIW039ML	CPS	9,4 W - 1050 lm		

KWID high dome, KWIW with ERT-LED clear flat dome

Distance table for KWIW029ML for plane emergency routes

Mounting height (m)					
2.00	8.81	20.69	13.93	7.41	2.95
2.50	9.91	23.35	15.50	8.00	3.11
3.00	10.74	25.73	16.91	8.52	3.18
3.50	11.21	27.89	18.07	8.80	3.18
4.00	11.61	29.88	18.79	8.96	3.14

Distance table for KWIW039ML for plane emergency routes

Mounting height (m)					
2.00	10.57	24.28	16.58	9.30	3.71
2.50	12.15	27.65	18.85	10.15	3.96
3.00	13.57	31.05	20.91	10.66	4.18
3.50	14.85	34.17	22.64	11.18	4.35
4.00	16.03	37.04	24.21	11.64	4.49

The distance table is based on the following parameters: Maintenance factor: 0.8; emergency lighting factor 1.00; Minimum illumination on the center line: 1.00 lux; Minimum illumination on the half width of the rescue

route: 0.50 lux, uniformity on the midline maximum 40:1; Width of the rescue route 2.00m

## CEILING MOUNTING / WALL MOUNTING

Dimensions KWI ceiling

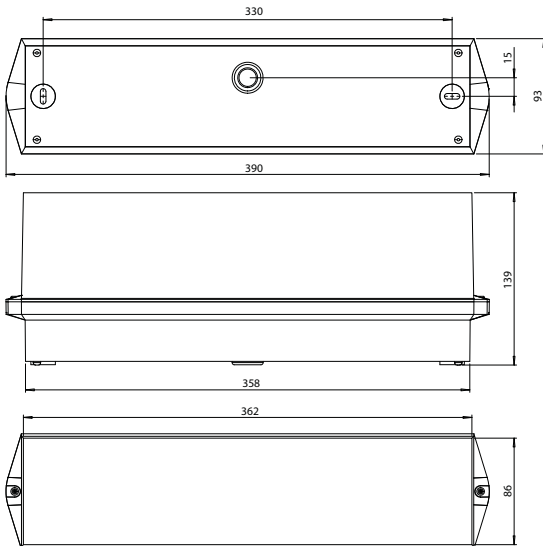

Dimensions KWI wall

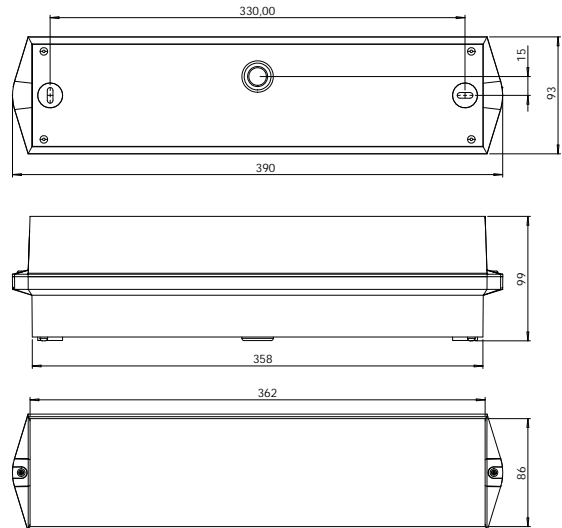

Dimensions KWIE recessed frame

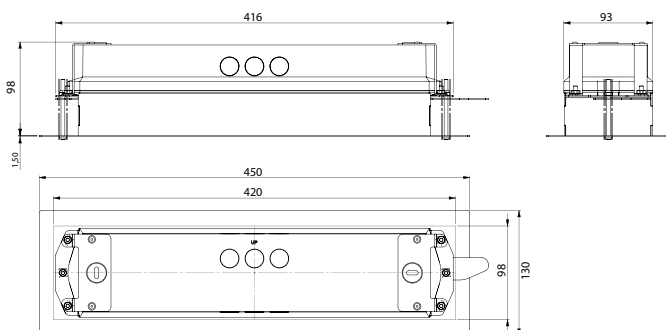

Drilling distances KWI ceiling / wall



All Dimensions in mm

## ACCESSORIES

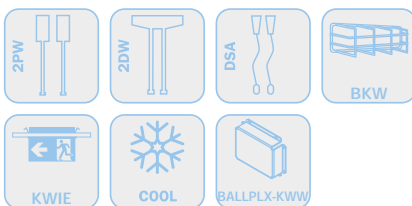

When mounting with cord suspension or pendulum the protection class is reduced to IP20.

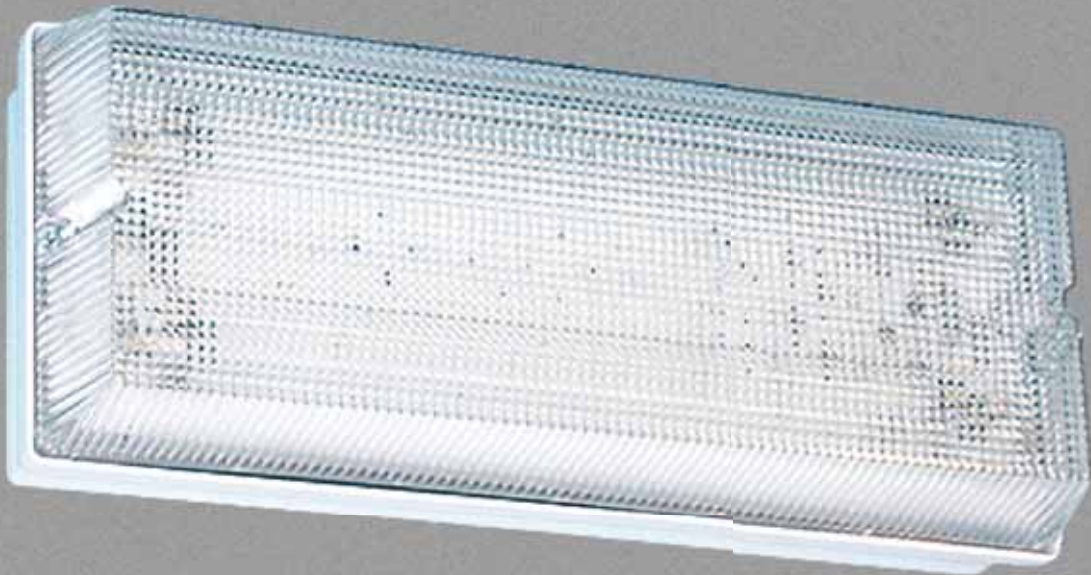

 **PF**  
PLASTIC LUMINAIRE

## FACTS

- Plastic, white
- Complete set of pictographs (ISO 7010)
- IP65
- Available for wall or ceiling mounting
- Self-Contained: -5° to +40°C  
Central battery: -30° to +40°C

Kunststoffleuchte zur Kennzeichnung und Ausleuchtung der Flucht- und Rettungswege nach DIN EN 60598-1, DIN EN 60598-2-22 und DIN EN 1838. Für ein- oder zweiseitige Beschriftung. Erhältlich als CPS- oder Einzelbatterie-Leuchte.

						
<b>SELF-CONTAINED LUMINAIRES WITH SELFCONTROL MODULE</b>						
LED, 1h, 230V AC	PFD011SC *	PFW011SC *	1 h	6,1 W	4,8V/2,0Ah NiMH	
LED, 1h, 230V AC		PFW021SC *	1 h	6 W - 520 lm	4,8V/2,0Ah NiMH	
LED, 3h, 230V AC	PFD013SC *	PFW013SC *	3 h	6,1 W	4,8V/2,0Ah NiMH	
LED, 3h, 230V AC		PFW023SC *	3 h	6 W - 260 lm	4,8V/2,0Ah NiMH	
LED, 8h, 230V AC	PFD018SC *	PFW018SC *	8 h	6,7 W	9,6V/2,0Ah NiMH	
<b>SELF-CONTAINED LUMINAIRES WITH WIRELESS PROFESSIONAL MODUL (NOT SWITCHABLE)</b>						
LED, 1h, 230V AC		PFW011WL *(SE)	1 h	7,5 W	12V/0,8Ah NiMH	
LED, 3h, 230V AC	PFD013WL *(SE)	PFW013WL *(SE)	3 h	7,5 W	12V/0,8Ah NiMH	
LED, 8h, 230V AC	PFD018WL *(SE)	PFW018WL *(SE)	8 h	7,5 W	12V/0,8Ah NiMH	
<b>LUMINAIRES FOR CORE COMPACT CENTRAL SYSTEMS 24V AC/DC INCL. MONITORING MODULE</b>						
LED, 24V AC/DC	PFD519CC	PFW519CC	CPS	3,8 W		
LED, 24V AC/DC		PFW529CC	CPS	3,8 W - 520 lm		
<b>LUMINAIRES FOR CENTRAL BATTERY SYSTEMS AC/DC</b>						
LED, 230V AC/DC	PFD019	PFW019	CPS	4,5 W		
LED, 230V AC/DC		PFW029	CPS	4,6 W - 520 lm		
<b>LUMINAIRES FOR CENTRAL BATTERY SYSTEMS AC/DC INCL. MONITORING MODULE</b>						
LED, 230V AC/DC	PFD019ML	PFW019ML	CPS	5,2 W		
LED, 230V AC/DC		PFW029ML	CPS	5,2 W - 520 lm		

\*) All versions also available as COOL-luminaires with external battery housing in IP20 for mounting within the building. The luminaire may be mounted outside or in cool stores.

Optional -EHE: with electronic heating element for use of the luminaire at temperatures low to - 15°C



(SE) Luminaires are switchable by radio with the optional switching extension with the Wireless Professional system.

Dimensions PF ceiling

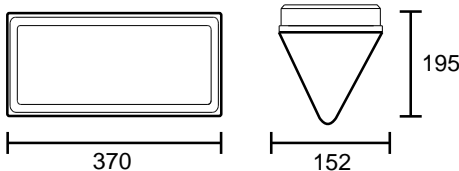

Dimensions PF wall

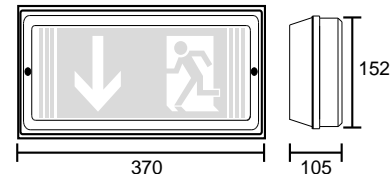

All Dimensions in mm



**V2W**

WALL MOUNTED STAINLESS STEEL LUMINAIRE



## FACTS

- Stainless steel V2A (optional V4A)
- Complete set of pictographs (ISO 7010)
- IP65
- Wall mounting
- Self-Contained: -5° to +40°C  
Central battery: -30° to +40°C

High quality vandal proof high-grade steel luminaire for wall mounting according to DIN EN 60598-1, DIN EN 60598-2-22 and EN 1838 for the marking and lighting of escape and rescue routes.

Service-friendly folding mechanism with external screws. Suitable for maintained or non-maintained mode.



<b>SELF-CONTAINED LUMINAIRES WITH SELFCONTROL MODULE</b>					
LED, 3h, 230V AC	V2W013SC *	3 h	6,1 W	4,8V/2,0Ah NiMH	
LED, 8h, 230V AC	V2W018SC *	8 h	6,7 W	9,6V/2,0Ah NiMH	
<b>LUMINAIRES FOR CENTRAL BATTERY SYSTEMS AC/DC</b>					
LED, 230V AC/DC	V2W019 *	CPS	4,5 W		
<b>LUMINAIRES FOR CENTRAL BATTERY SYSTEMS AC/DC INCL. MONITORING MODULE</b>					
LED, 230V AC/DC	V2W019ML *	CPS	5,2 W		

\* Optional with floatglass (detergent resistant)

## WALL MOUNTING

Dimensions V2W

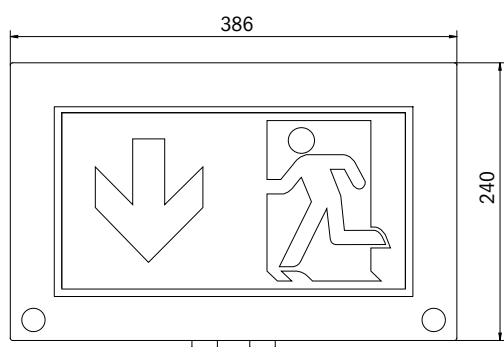

All Dimensions in mm

Drilling distances V2W

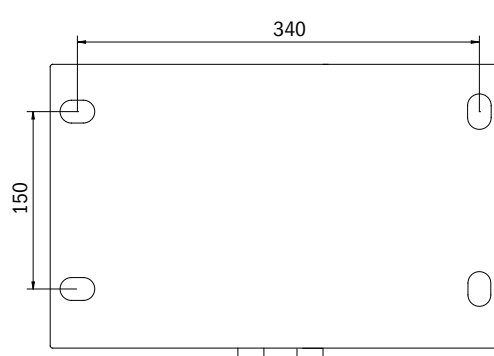

## ACCESSORIES



\*\* Only in optional V4A version suitable for use in swimming pools or slaughterhouses (not chlorine / chemical resistant)



 **WH**  
POLYCARBONATE CUBIC LUMINAIRES





## FACTS

- Plastic, white
- Viewing Distance : 30m / 50m
- IP65
- Mounting:  
Ceiling, Pendulum, Chain
- SelfContained: -5° to +40°C  
Central battery: -30° to +40°C

Due to the cube shape, this plastic luminaire is easily recognizable from four sides. It is ideal for applications at crossroads, such as in department stores with aisles.

Planning security is provided by logically specified imprinted pictograms.

LED exit sign luminaire according to DIN EN 60598-1, DIN EN 60598-2-22, DIN EN 7010 and DIN EN 1838.



## WHX (30M)

<b>SELF-CONTAINED LUMINAIRES WITH SELFCONTROL MODULE</b>					
LED, 1h, 230V AC	WHXD011SC	1 h	6 W	4,8V/2,0Ah NiMH	
LED, 3h, 230V AC	WHXD013SC	3 h	6 W	4,8V/2,0Ah NiMH	
LED, 8h, 230V AC	WHXD018SC	8 h	7,1 W	9,6V/2,0Ah NiMH	
<b>LUMINAIRES FOR CORE COMPACT CENTRAL SYSTEMS 24V AC/DC INCL. MONITORING MODULE</b>					
LED, 24V AC/DC	WHXD519CC	CPS	5,2 W		
<b>LUMINAIRES FOR CENTRAL BATTERY SYSTEMS AC/DC</b>					
LED, 230V AC/DC	WHXD019	CPS	4,6 W		
<b>LUMINAIRES FOR CENTRAL BATTERY SYSTEMS AC/DC INCL. MONITORING MODULE</b>					
LED, 230V AC/DC	WHXD019ML	CPS	5,2 W		



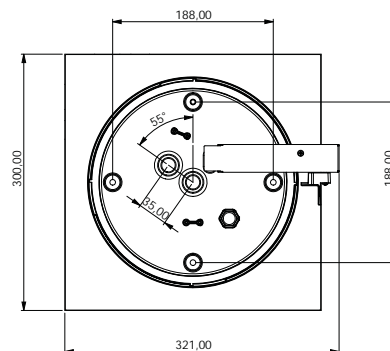
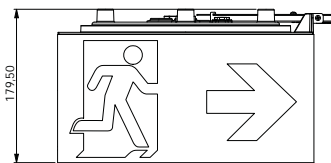





Dimensions WHX



WKO: 4 chain eyelets for suspended mounting

## POLYCARBONATE CUBIC LUMINAIRES

### WHG (50M)

					
<b>SELF-CONTAINED LUMINAIRES WITH SELFCONTROL MODULE</b>					
LED, 1h, 230V AC	WHGD011SC	1 h	6 W	4,8V/2,0Ah NiMH	
LED, 3h, 230V AC	WHGD013SC	3 h	6 W	4,8V/2,0Ah NiMH	
LED, 8h, 230V AC	WHGD018SC	8 h	7,1 W	9,6V/2,0Ah NiMH	
<b>LUMINAIRES FOR CENTRAL BATTERY SYSTEMS AC/DC</b>					
LED, 230V AC/DC	WHGD019	CPS	4,6 W		
<b>LUMINAIRES FOR CENTRAL BATTERY SYSTEMS AC/DC INCL. MONITORING MODULE</b>					
LED, 230V AC/DC	WHGD019ML	CPS	5,2 W		



Dimensions WHG

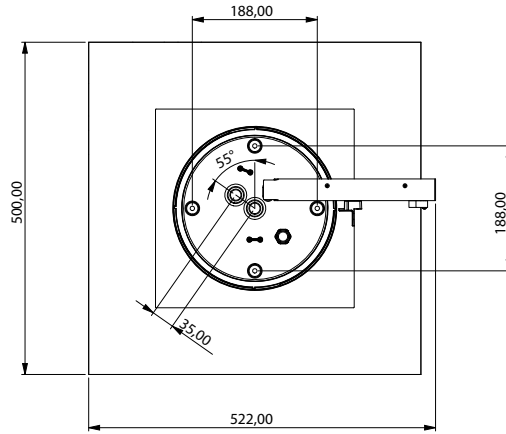
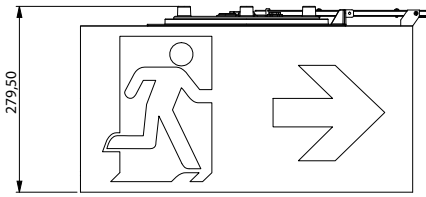

WKO: 4 chain eyelets for suspended mounting

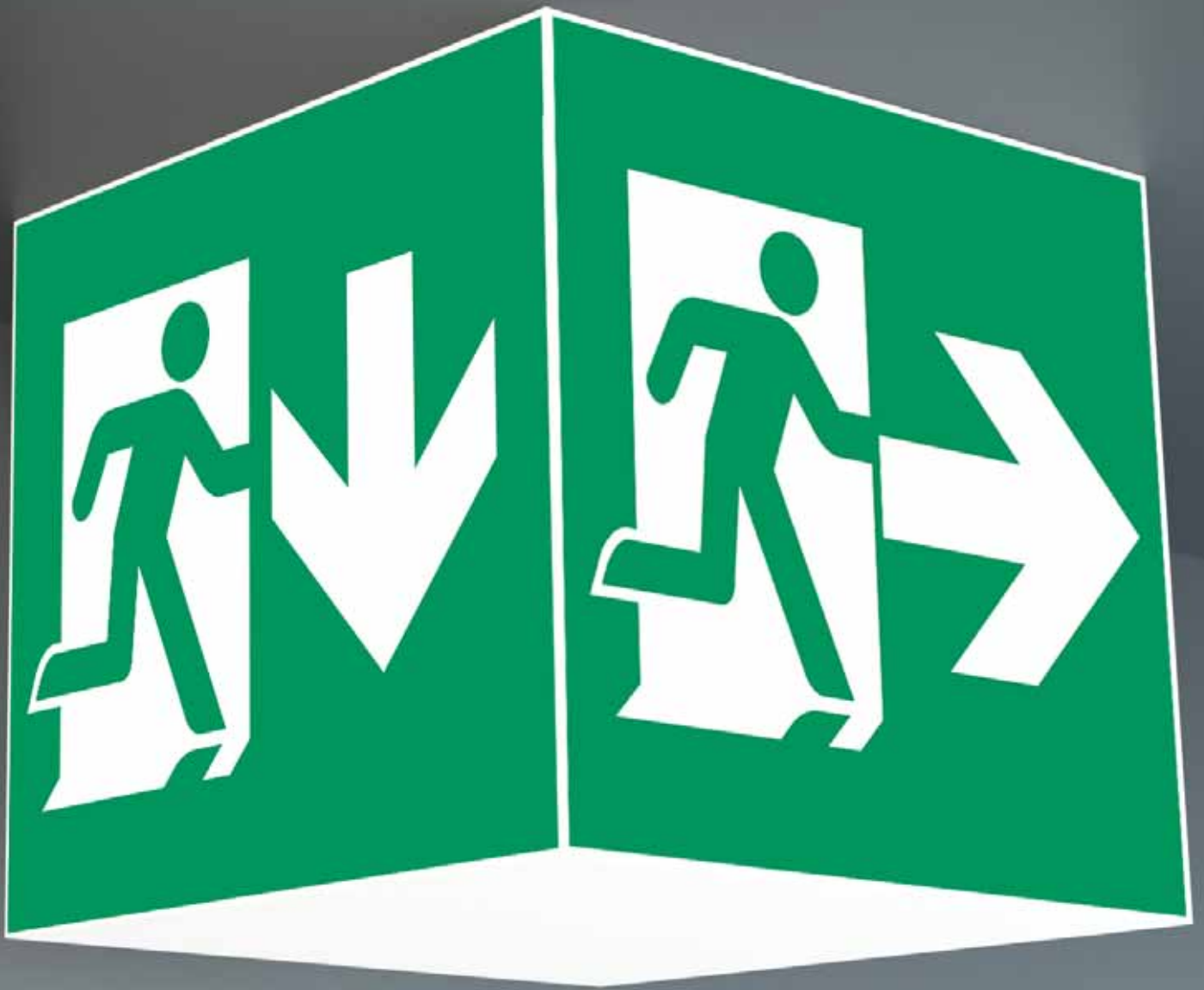

**WK / WG / WX**

POLYCARBONATE CUBIC LUMINAIRES



## FACTS

- Polycarbonate, white
- Recognition distance  
WK: 36m, WG: 46m, WX: 90m
- IP20
- Mounting:  
Wall, Ceiling, Pendulum, Chain
- Self-contained: -5° to +40°C  
Central battery systems:  
-30° to +40°C

Due to the cube shape, this plastic lamp is easily recognizable from four sides. This makes it ideal for applications at crossings, such as in department stores with aisles.

Planning security is provided by logically specified, printed pictograms.

LED escape sign luminaire according to DIN EN 60598-1, DIN EN 60598-2-22, DIN EN 7010 and DIN EN 1838.



## WK (36M)

<b>SELF-CONTAINED LUMINAIRES</b>						
LED, 3h, 230V AC	WKD013		3 h	6,1 W	4,8V/2,0Ah NiMH	
LED, 8h, 230V AC	WKD018		8 h	6,7 W	9,6V/2,0Ah NiMH	
<b>SELF-CONTAINED LUMINAIRES WITH SELFCONTROL MODULE</b>						
LED, 1h, 230V AC	WKD011SC	WKW011SC	1 h	6,1 W	4,8V/2,0Ah NiMH	
LED, 3h, 230V AC	WKD013SC	WKW013SC	3 h	6,1 W	4,8V/2,0Ah NiMH	
LED, 8h, 230V AC	WKD018SC		8 h	6,7 W	9,6V/2,0Ah NiMH	
<b>SELF-CONTAINED LUMINAIRES WITH WIRELESS PROFESSIONAL MODULE (NOT SWITCHABLE)</b>						
LED, 1h, 230V AC	WKD011WL	WKW011WL	1 h	7,5 W	12V/0,8Ah NiMH	
LED, 3h, 230V AC	WKD013WL	WKW013WL	3 h	7,5 W	12V/0,8Ah NiMH	
LED, 8h, 230V AC	WKD018WL		8 h	7,5 W	12V/0,8Ah NiMH	
<b>LUMINAIRES FOR CENTRAL BATTERY SYSTEMS AC/DC</b>						
LED, 230V AC/DC	WKW019		CPS	4,5 W		
<b>LUMINAIRES FOR CENTRAL BATTERY SYSTEMS AC/DC INCL. MONITORING MODULE</b>						
LED, 230V AC/DC	WKD019ML		CPS	5,2 W		

Dimensions WK

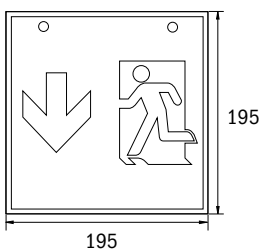



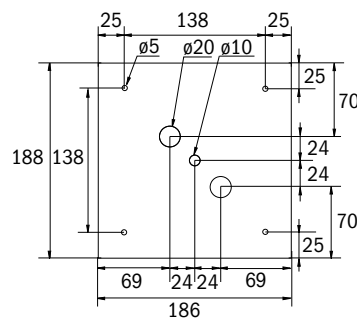









Drilling distances WK













# » WK / WG / WX

## POLYCARBONATE CUBIC LUMINAIRES

### WG (46M)

					
<b>SELF-CONTAINED LUMINAIRES</b>					
LED, 3h, 230V AC	WGD013		3 h	6,1 W	4,8V/2,0Ah NiMH
<b>SELF-CONTAINED LUMINAIRES WITH SELFCONTROL MODULE</b>					
LED, 1h, 230V AC	WGD011SC	WGW011SC	1 h	6,1 W	4,8V/2,0Ah NiMH 
LED, 3h, 230V AC	WGD013SC	WGW013SC	3 h	6,1 W	4,8V/2,0Ah NiMH 
<b>SELF-CONTAINED LUMINAIRES WITH WIRELESS PROFESSIONAL MODULE (NOT SWITCHABLE)</b>					
LED, 1h, 230V AC	WGD011WL	WGW011WL	1 h	7,5 W	12V/0,8Ah NiMH 
LED, 3h, 230V AC	WGD013WL	WGW013WL	3 h	7,5 W	12V/0,8Ah NiMH 
LED, 8h, 230V AC	WGD018WL		8 h	6,7 W	9,6V/2,0Ah NiMH 
<b>LUMINAIRES FOR CENTRAL BATTERY SYSTEMS AC/DC</b>					
LED, 230V AC/DC	WGD019	WGW019	CPS	4,5 W	
<b>LUMINAIRES FOR CENTRAL BATTERY SYSTEMS AC/DC INCL. MONITORING MODULE</b>					
LED, 230V AC/DC	WGW019ML		CPS	5,2 W	

### WX (90M)

					
<b>SELF-CONTAINED LUMINAIRES</b>					
LED, 3h, 230V AC	WXD013		3 h	6,1 W	4,8V/2,0Ah NiMH
<b>SELF-CONTAINED LUMINAIRES WITH SELFCONTROL MODULE</b>					
LED, 1h, 230V AC	WXD011SC		1 h	6,1 W	4,8V/2,0Ah NiMH 
LED, 3h, 230V AC	WXD013SC		3 h	6,1 W	4,8V/2,0Ah NiMH 
<b>SELF-CONTAINED LUMINAIRES WITH WIRELESS PROFESSIONAL MODULE (NOT SWITCHABLE)</b>					
LED, 1h, 230V AC	WXD011WL		1 h	7,5 W	12V/0,8Ah NiMH 
LED, 3h, 230V AC	WXD013WL		3 h	7,5 W	12V/0,8Ah NiMH 
<b>LUMINAIRES FOR CENTRAL BATTERY SYSTEMS AC/DC</b>					
LED, 230V AC/DC	WXD019		CPS	4,5 W	
<b>LUMINAIRES FOR CENTRAL BATTERY SYSTEMS AC/DC INCL. MONITORING MODULE</b>					
LED, 230V AC/DC	WXD019ML		CPS	5,2 W	



Dimensions WG

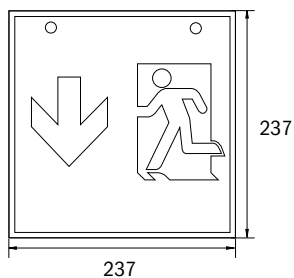

Drilling distances WG

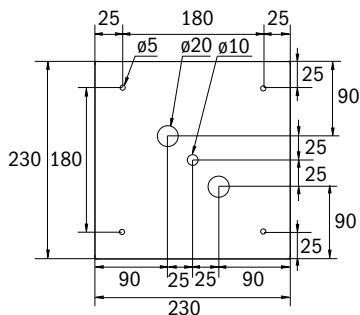

Dimensions WX

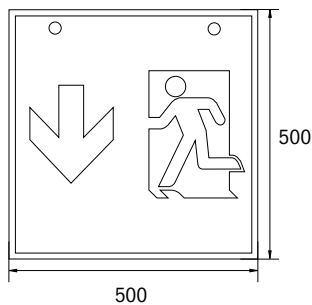

Drilling distances WX

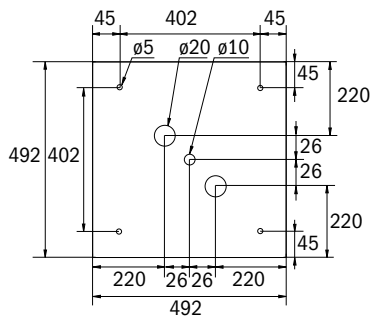

## ACCESSORIES

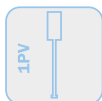

WKO: 4 chain eyelets for suspended mounting

WK



**WFXW**

POLYCARBONATE CUBIC LUMINAIRES





## FACTS

- Polycarbonate, white
- Recognition distance 60m
- IP65
- Wall mounting
- Self-contained luminaires:  
0° to +35°C  
Central battery systems:  
-20° to +40°C

Exit sign in square format for marking the escape and rescue routes with installation-friendly bayonet lock. Included in delivery is a standard pictogram (right, left, top or down) as specified.

Optionally, it is possible to use the luminaire to mark other ancillary rooms.



<b>SELF-CONTAINED LUMINAIRES WITH SELFCONTROL MODULE</b>					
LED, 1h, 230V AC	WFXW011SC	1h	6W - 520 lm	4,8V/2,0Ah NiMH	
LED, 3h, 230V AC	WFXW013SC	3h	6W - 260 lm	4,8V/2,0Ah NiMH	
LED, 8h, 230V AC	WFXW018SC	8h	7,1W - 220 lm	9,6V/2,0Ah NiMH	
<b>LUMINAIRES FOR CENTRAL BATTERY SYSTEMS AC/DC INCL. MONITORING MODULE</b>					
LED, 230V AC/DC	WFXW019ML	CPS	5,2W - 520 lm		

## WALL MOUNTING

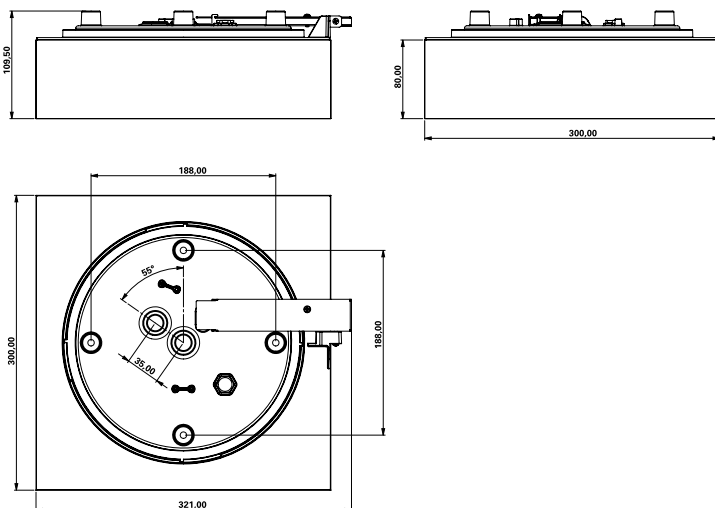

All dimensions in mm



XI

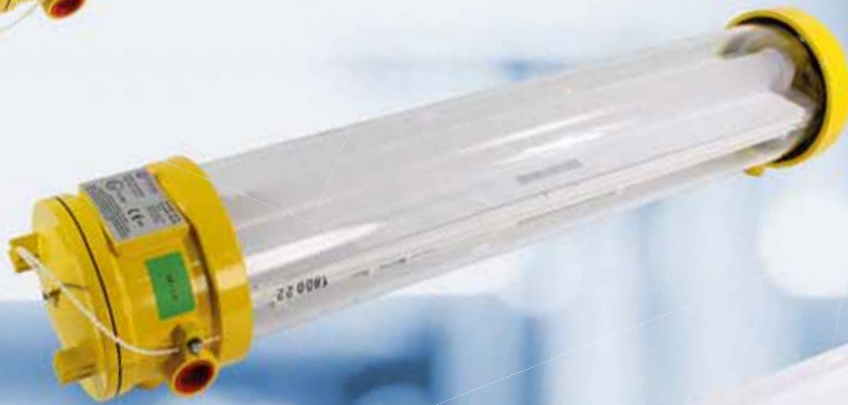

XM



XX

 **XI / XM / XX**  
EXPLOSION PROOF LUMINAIRES

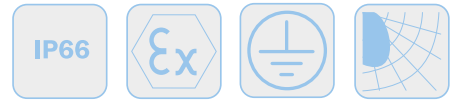

## FACTS

- Explosion proof glass or polycarbonate cylinder
- IK05 (polycarbonate cylinder) IK07 (glass cylinder)
- IP66
- Wall or ceiling mounting
- 0°C to +40°C (SelfContained) -20°C to +40°C (CBS)

Explosion-proof LED glass or polycarbonate cylinder Safety light for gas and dust Ex zones. Available in three sizes with a luminous flux of up to 5000lm.

Prepared for two cable entries for through-wiring. By applying a pictogram can also be used as a exit sign.

Mounting options Wall or ceiling mounting with adapter or suspension with chain eye.

**According to 94/9/EG (ATEX) Zone 1 / Zone 21 gas and dust**  
 • Ex d IIB T6 Gb / Ex d IIB T6 Gb  
 • Ex t IIIC T85°C Db

## XI (GLASS CYLINDER)



<b>SELF-CONTAINED LUMINAIRES WITH SELFCONTROL MODULE</b>					
LED, 1h, 230V AC - Non maintained mode	XGIU001SC-BS *	1 h	5,8 W - 350 lm	3,6V/1,6Ah NiCd	
LED, 1h, 230V AC - maintained-/non-maintained mode	XGIU011SC *	1 h	24 W - 750 lm	6V/1,6Ah NiCd	
LED, 3h, 230V AC - Non maintained mode	XGIU003SC-BS *	3 h	6,9 W - 350 lm	3,6V/1,6Ah NiCd	
<b>LUMINAIRES FOR CENTRAL BATTERY SYSTEMS AC/DC</b>					
LED, 230V AC/DC	XGIU009 *	CPS	11 W - 1200 lm		
LED, 230V AC/DC	XGIU019 *	CPS	20 W - 2100 lm		
<b>LUMINAIRES FOR CENTRAL BATTERY SYSTEMS AC/DC INCL. MONITORING MODULE</b>					
LED, 230V AC/DC	XGIU009ML *	CPS	11 W - 1200 lm		
LED, 230V AC/DC	XGIU019ML *	CPS	20 W - 2100 lm		

\*) only on request

## XI (POLYCARBONATE CYLINDER)



<b>SELF-CONTAINED LUMINAIRES WITH SELFCONTROL MODULE</b>					
LED, 1h, 230V AC - Non maintained mode	XPIU001SC-BS *	1 h	5,8 W - 350 lm	3,6V/1,6Ah NiCd	
LED, 1h, 230V AC - maintained-/non-maintained mode	XPIU011SC *	1 h	24 W - 750 lm	6V/1,6Ah NiCd	
LED, 1h, 230V AC - maintained-/non-maintained mode	XPIU011SC-NI	1 h	24 W - 750 lm	6V/1,6Ah NiMH	
LED, 3h, 230V AC - Non maintained mode	XPIU003SC-BS *	3 h	6,9 W - 350 lm	3,6V/1,6Ah NiCd	
<b>LUMINAIRES FOR CENTRAL BATTERY SYSTEMS AC/DC</b>					
LED, 230V AC/DC	XPIU009 *	CPS	11 W - 1200 lm		
LED, 230V AC/DC	XPIU019 *	CPS	20 W - 2100 lm		
<b>LUMINAIRES FOR CENTRAL BATTERY SYSTEMS AC/DC INCL. MONITORING MODULE</b>					
LED, 230V AC/DC	XPIU009ML	CPS	11 W - 1200 lm		
LED, 230V AC/DC	XPIU019ML *	CPS	20 W - 2100 lm		

\*) only on request

## EXPLOSION PROOF LUMINAIRES

### XM (GLASS CYLINDER)



<b>SELF-CONTAINED LUMINAIRES WITH SELFCONTROL MODULE</b>					
LED, 1h, 230V AC - Non-maintained mode	XGMU001SC-BS *	1 h	5,8 W - 700 lm	6V/1,6Ah NiCd	
LED, 1h, 230V AC - maintained-/Non-maintained mode	XGMU011SC *	1 h	40 W - 750 lm	6V/1,6Ah NiCd	
LED, 1h, 230V AC - maintained-/Non-maintained mode	XGMU013SC *	3 h	40 W - 750 lm	6V/4Ah NiCd	
LED, 3h, 230V AC - Non-maintained mode	XGMU003SC-BS *	3 h	9,2 W - 750 lm	6V/4Ah NiCd	
<b>LUMINAIRES FOR CENTRAL BATTERY SYSTEMS AC/DC</b>					
LED, 230V AC/DC	XGMU009 *	CPS	20 W - 2400 lm		
LED, 230V AC/DC	XGMU019 *	CPS	40 W - 4600 lm		
<b>LUMINAIRES FOR CENTRAL BATTERY SYSTEMS AC/DC INCL. MONITORING MODULE</b>					
LED, 230V AC/DC	XGMU009ML *	CPS	20 W - 2400 lm		
LED, 230V AC/DC	XGMU019ML *	CPS	40 W - 4600 lm		

\*) only on request

### XM (POLYCARBONATE CYLINDER)



<b>SELF-CONTAINED LUMINAIRES WITH SELFCONTROL MODULE</b>					
LED, 1h, 230V AC - Non-maintained mode	XPMU001SC-BS *	1 h	5,8 W - 700 lm	6V/1,6Ah NiCd	
LED, 1h, 230V AC - maintained-/Non-maintained mode	XPMU011SC *	1 h	40 W - 750 lm	6V/1,6Ah NiCd	
LED, 3h, 230V AC - Non-maintained mode	XPMU003SC-BS *	3 h	9,2 W - 750 lm	6V/4Ah NiCd	
LED, 3h, 230V AC - maintained-/Non-maintained mode	XPMU013SC *	3 h	40 W - 750 lm	6V/4Ah NiCd	
LED, 3h, 230V AC - maintained-/Non-maintained mode	XPMU013SC-NI	3 h	40 W - 750 lm	6V/4Ah NiMH	
<b>LUMINAIRES FOR CENTRAL BATTERY SYSTEMS AC/DC</b>					
LED, 230V AC/DC	XPMU009 *	CPS	20 W - 2400 lm		
LED, 230V AC/DC	XPMU019 *	CPS	40 W - 4600 lm		
<b>LUMINAIRES FOR CENTRAL BATTERY SYSTEMS AC/DC INCL. MONITORING MODULE</b>					
LED, 230V AC/DC	XPMU009ML *	CPS	20 W - 2400 lm		
LED, 230V AC/DC	XPMU019ML	CPS	40 W - 4600 lm		

\*) only on request

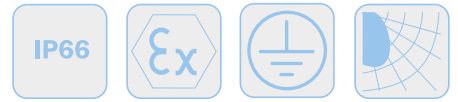

## XX (GLASS CYLINDER)



SELF-CONTAINED LUMINAIRES WITH SELFCONTROL MODULE					
LED, 1h, 230V AC - maintained-/Non-maintained mode	XGXU011SC *	1 h	45 W - 750 lm	6V/1,5Ah NiCd	
LED, 3h, 230V AC - maintained-/Non-maintained mode	XGXU013SC *	3 h	45 W - 750 lm	6V/4Ah NiCd	
LUMINAIRES FOR CENTRAL BATTERY SYSTEMS AC/DC					
LED, 230V AC/DC	XGXU009 *	CPS	40 W - 4600 lm		
LUMINAIRES FOR CENTRAL BATTERY SYSTEMS AC/DC INCL. MONITORING MODULE					
LED, 230V AC/DC	XGXU009ML *	CPS	40 W - 4600 lm		

\*) only on request

## XX (POLYCARBONATE CYLINDER)



SELF-CONTAINED LUMINAIRES WITH SELFCONTROL MODULE					
LED, 1h, 230V AC - maintained-/Non-maintained mode	XPXU011SC *	1 h	45 W - 750 lm	6V/1,5Ah NiCd	
LED, 3h, 230V AC - maintained-/Non-maintained mode	XPXU013SC *	3 h	45 W - 750 lm	6V/4Ah NiCd	
LUMINAIRES FOR CENTRAL BATTERY SYSTEMS AC/DC					
LED, 230V AC/DC	XPXU009 *	CPS	40 W - 4600 lm		
LUMINAIRES FOR CENTRAL BATTERY SYSTEMS AC/DC INCL. MONITORING MODULE					
LED, 230V AC/DC	XPXU009ML	CPS	40 W - 4600 lm		

\*) only on request

## ACCESSORIES



4-fold pictograph set  
Viewing distance 14m.

X4N

Art.-No. X4N



Chain eyes  
Art.-No. X-KO001

X-KO001



Mounting brackets for wall/ceiling mounting  
Art.-No. X-MB001





X-MB001







Metal cable gland with strain relief

## EXPLOSION PROOF LUMINAIRES





Distance table XGIU003SC for plane emergency routes

Mounting height (m)					
2.00	4.04	9.73	9.58	9.44	3.94
2.50	4.44	10.79	10.66	10.52	4.33
3.00	4.75	11.72	11.58	11.43	4.64
3.50	4.98	12.52	12.37	12.21	4.89
4.00	5.14	13.17	13.01	12.86	5.08

Distance table XGMU013SC for plane emergency routes

Mounting height (m)					
2.00	4.60	11.40	10.34	9.30	3.89
2.50	5.50	13.65	12.44	11.22	4.68
3.00	5.88	14.65	13.47	12.26	5.07
3.50	6.21	15.51	14.36	13.16	5.42
4.00	6.46	16.29	15.14	13.92	5.72

Distance table XGXU013SC for plane emergency routes

Mounting height (m)					
2.00	5.18	12.92	11.70	10.49	4.35
2.50	5.89	14.84	13.48	12.12	5.01
3.00	6.22	15.84	14.48	13.14	5.38
3.50	6.52	16.62	15.29	14.02	5.69
4.00	6.76	17.28	16.05	14.82	5.96

The distance table is based on the following parameters: Maintenance factor: 0.8; emergency lighting factor 1.00; Minimum illumination on the center line: 1.00 lux; Minimum illumination on the half width of the rescue route: 0.50 lux, uniformity on the midline maximum 40:1; Width of the rescue route 2.00m

The luminaire distances for luminaires with polycarbonate cylinders is approx. 10-15% smaller than the distances specified in these tables for luminaires with glass cylinders.



Dimensions XI



Dimensions XM

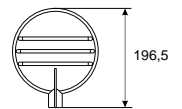
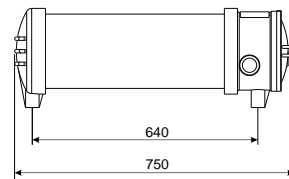
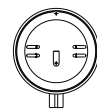
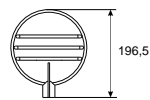
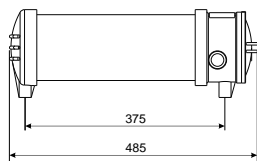
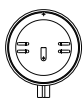
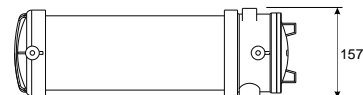

Dimensions XX

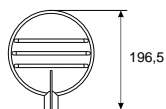
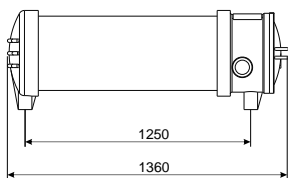
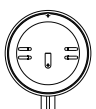
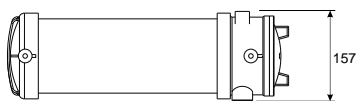



**U6**

RECESSED WALL MOUNTED LUMINAIRE





## FACTS

- Zinc housing, white
- Complete set of pictographs (ISO 7010)
- IP40
- 22m viewing distance
- Recessed wall mounting
- SelfContained: -5° to +40°C  
Central battery: -30° to +40°C

Integrated into the wall this escape route indication luminaire adapts to the interior design. The variable use and toolless change of pictograms provides planning security on site.

LED escape route luminaire for recessed wall mounting according to DIN EN 60598-1, EN 60598-2-22, EN 7010 and DIN EN 1838.



<b>SELF-CONTAINED LUMINAIRES WITH SELFCONTROL MODULE</b>					
LED, 1h, 230V AC	U6E011SC	1 h	6,1 W	4,8V/2,0Ah NiMH	
LED, 3h, 230V AC	U6E013SC	3 h	6,1 W	4,8V/2,0Ah NiMH	
<b>SELF-CONTAINED LUMINAIRES WITH WIRELESS PROFESSIONAL MODUL (NOT SWITCHABLE)</b>					
LED, 3h, 230V AC	U6E013WL	3 h	7,5 W	12V/0,8Ah NiMH	
<b>LUMINAIRES FOR CENTRAL BATTERY SYSTEMS AC/DC</b>					
LED, 230V AC/DC	U6E019	CPS	4,5 W		
<b>LUMINAIRES FOR CENTRAL BATTERY SYSTEMS AC/DC INCL. MONITORING MODULE</b>					
LED, 230V AC/DC	U6E019ML	CPS	5,2 W		

## RECESSED WALL MOUNTING

Dimensions U6

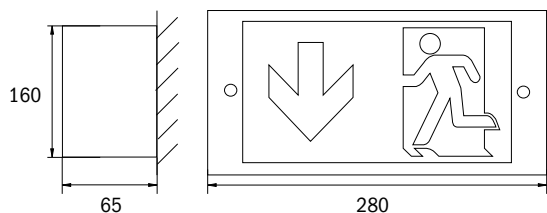

Cut-Out U6

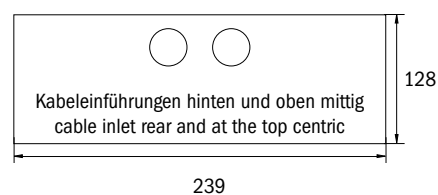

All Dimensions in mm



 **SKS / SGS**  
EMERGENCY FLOODLIGHT



## FACTS

- Steelsheet housing
- IP54
- Wall mounting
- -5°C to +40°C

Emergency floodlight in a non-maintained circuit for lighting spaces or emergency routes with pre-mounted or externally mountable floodlights, for fixed location or transportable. Remote monitoring via Wireless Professional is possible. Technical specifications with deep discharge protection and integrated lock against switching back on, limit switch, IC technology.

With maintenance free, long-life, gas-proof, Pb rechargeable batteries, electronic construction with switching option as well as LED function monitoring indicator.







<b>SELF-CONTAINED LUMINAIRES WITH SELFCONTROL MODULE</b>					
LED Emergency floodlight, 230V AC	SKS2101SC	1 h	2 x 900 lm	AGM Battery 12V 9Ah	
LED Emergency floodlight, 230V AC	SKS2103SC	3 h	2 x 900 lm	AGM Battery 12V 9Ah	
LED Emergency floodlight, 230V AC	SKS2108SC	8 h	2 x 900 lm	AGM Battery 12V 17Ah	
LED Emergency floodlight, 230V AC	SKS2301SC	1 h	2 x 2500 lm	AGM Battery 12V 17Ah	
LED Emergency floodlight, 230V AC	SGS2303SC	3 h	2 x 2500 lm	AGM Battery 12V 28Ah	
LED Emergency floodlight, 230V AC	SGS1308SC	8 h	2 x 900 lm	AGM Battery 12V 28Ah	
LED Emergency floodlight, 230V AC	SGS2501SC	1 h	2 x 4100 lm	AGM Battery 12V 28Ah	
LED Emergency floodlight, 230V AC	SGS2503SC	3 h	2 x 4100 lm	AGM Battery 12V 40Ah	
<b>SELF-CONTAINED LUMINAIRES WITH WIRELESS PROFESSIONAL MODUL (NOT SWITCHABLE)</b>					
LED Emergency floodlight, 230V AC	SKS2101WL	1 h	2 x 900 lm	AGM Battery 12V 9Ah	
LED Emergency floodlight, 230V AC	SKS2103WL	3 h	2 x 900 lm	AGM Battery 12V 9Ah	
LED Emergency floodlight, 230V AC	SKS2108WL	8 h	2 x 900 lm	AGM Battery 12V 17Ah	
LED Emergency floodlight, 230V AC	SKS2301WL	1 h	2 x 2500 lm	AGM Battery 12V 17Ah	
LED Emergency floodlight, 230V AC	SGS2303WL	3 h	2 x 2500 lm	AGM Battery 12V 28Ah	
LED Emergency floodlight, 230V AC	SGS1308WL	8 h	2 x 900 lm	AGM Battery 12V 28Ah	
LED Emergency floodlight, 230V AC	SGS2501WL	1 h	2 x 4100 lm	AGM Battery 12V 28Ah	
LED Emergency floodlight, 230V AC	SGS2503WL	3 h	2 x 4100 lm	AGM Battery 12V 40Ah	





Note: Versions with 30 / 50W LED floodlight don't have lights mounted on the housing. The illuminants have to be mounted separately within max. 1m distance.

## EMERGENCY FLOODLIGHT

Distance table SKS2101 for plane emergency routes. The luminaire distances are measured with the theoretical ceiling mount of the luminaire.

Mounting height (m)					
2,00	3,46	6,91	8,26	9,16	4,29
2,50	4,16	8,64	10,33	11,45	5,13
3,00	4,80	10,07	11,82	13,14	5,64
3,50	5,39	11,38	13,10	14,48	6,06
4,00	5,93	12,58	14,16	15,57	6,40
5,00	6,64	14,74	16,26	17,44	7,14
6,00	7,40	16,62	18,10	18,96	7,40
7,00	7,78	18,28	19,62	20,22	7,78
7,50	7,77	19,02	20,25	20,73	7,77
8,00	7,72	19,74	20,80	21,14	7,72
9,00	7,56	20,67	21,78	21,87	7,56
10,00	7,28	21,36	22,16	22,16	7,28
10,50	7,08	21,51	22,20	22,23	7,08
12,00	6,93	21,72	22,02	22,08	6,39
14,00	6,52	20,80	21,16	21,24	4,84
16,00	0,84	19,84	20,00	19,80	0,56

Distance table SGS1308 for plane emergency routes. The luminaire distances are measured with the theoretical ceiling mount of the luminaire.

Mounting height (m)					
2,00	4,10	9,23	9,47	10,09	4,29
2,50	5,13	11,54	11,84	12,61	5,36
3,00	6,15	13,85	14,21	15,13	6,43
3,50	7,18	16,16	16,57	17,66	7,51
4,00	8,20	18,47	18,94	20,18	8,58
5,00	9,40	22,60	23,04	24,34	10,26
6,00	10,82	25,68	25,80	26,70	10,82
7,00	11,20	27,94	28,00	28,72	11,64
7,50	11,55	28,98	29,01	29,61	12,00
8,00	11,86	29,96	29,98	30,48	12,32
9,00	12,39	31,77	31,74	32,04	12,84
10,00	12,80	33,20	33,16	33,40	13,28
10,50	12,96	33,78	33,75	34,02	13,44
12,00	13,32	35,34	35,37	35,67	13,80
14,00	13,52	36,92	37,00	37,36	14,00
16,00	13,44	38,08	38,20	38,60	13,92



Distance table SGS2501 / SGS2503 for plane emergency routes. The luminaire distances are measured with the theoretical ceiling mount of the luminaire.

Mounting height (m)					
2,00	3,76	8,20	8,60	9,15	4,10
2,50	4,70	10,25	10,74	11,43	5,13
3,00	5,64	12,30	12,89	13,72	6,15
3,50	6,58	14,36	15,04	16,01	7,18
4,00	7,52	16,40	17,20	18,30	8,20
5,00	9,40	20,50	21,48	22,86	10,26
6,00	11,28	24,60	25,79	27,44	12,30
7,00	12,62	28,08	29,14	31,02	13,16
7,50	12,99	29,58	30,51	32,49	13,53
8,00	13,85	31,04	31,80	33,69	13,85
9,00	14,40	33,78	34,26	35,70	14,40
10,00	14,85	36,33	36,49	37,49	15,40
10,50	15,00	37,53	37,56	38,34	15,57
12,00	15,92	40,48	40,18	40,64	16,52
14,00	16,67	43,05	42,69	43,20	17,29
16,00	16,56	45,04	44,72	45,30	17,76

The distance table is based on the following parameters: Maintenance factor: 0.8; emergency lighting factor 1.00; Minimum illumination on the center line: 1.00 lux; Minimum illumination on the half width of the rescue route: 0.50 lux, uniformity on the midline maximum 40:1; Width of the rescue route 2.00m

For a light calculation adapted to the particular mounting situation and alignment of the spotlights, please use a software for the light calculation and the provided LDT files.

## WALL MOUNTING

Dimensions SKS 9Ah, 17Ah

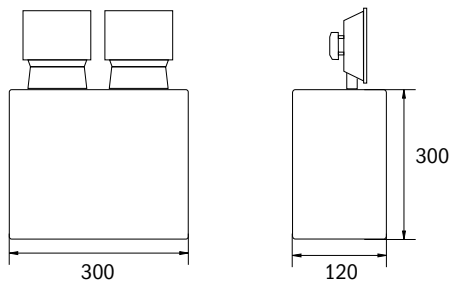

Dimensions SGS 28Ah, 40Ah

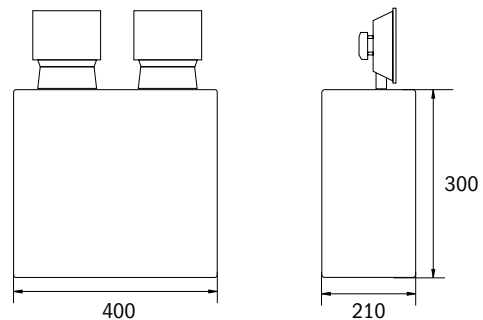

All Dimensions in mm



 **HX**  
HANDHELD SPOTLIGHT

IP54



230V AC  
12V AC

## FACTS

- Polycarbonate, impact-resistant, black
- IP54
- 3 Watt Power-LED, white
- Li-ion battery maintenance-free 7,4V
- Charging time max. 6 hrs.
- Operating time at 100% luminosity: 5 hrs at 25% luminosity: 10 hrs
- Charging voltage: 230V AC or 12V DC
- Weight: 655g

Rechargeable Signal Lamp with 3W Power-LED and magnetic socket for professional use.

Upon mains failure the emergency function turns the light on automatically. Swiveling Lamp head with tilt angle 70° slew forward and 110° backward. Including flashing as well as dimmed mode for longer operation time. Wall bracket with charger function (230V supply).



<b>SELF-CONTAINED LUMINAIRES</b>			
LED 230V AC, 4h	HX	3 h - 180 lm	Li-Ion, 7,4V



An explosion proof version is available on request.

### Dimensions

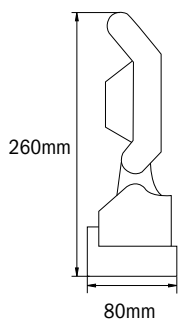

All Dimensions in mm

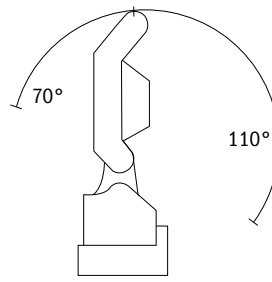
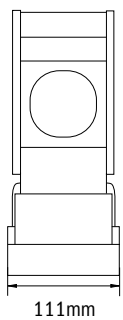

Distance to the handheld spotlight	luminosity (un-dimmed)
1m	5100 lux
2m	1100 lux
3m	525 lux
4m	415 lux
5m	320 lux
10m	100 lux



## GENERAL-PURPOSE LIGHTING FOR SAFETY USE







 **QAW**  
GENERAL PURPOSE AND EMERGENCY LIGHTING



## FACTS

- Metal housing with PMMA Cover
- IP20
- Wall or ceiling mounting
- Self-Contained: -5° to +40°C  
Central battery: -30° to +40°C

Round metal luminaire for general lighting and the lighting of escape and rescue routes according to DIN EN 60598-1, DIN EN 60598-2-22 and EN 1838.

In mains operation the luminaire works with 26W / 1.600lm LED. Available for central power systems or as a self-contained emergency luminaire - on request with motion sensor.

SELF-CONTAINED LUMINAIRES WITH SELFCONTROL MODULE			(lm in battery operation)		
LED, 1h, 230V AC	QAW421SC *	QAW421SC-SI*	1 h	29,7 W - 250 lm	3,2V/3,3Ah LiFePO4
LED, 3h, 230V AC	QAW403SC *	QAW403SC-SI*	3 h	30 W - 360 lm	3,2V/4,5Ah LiFePO4
LED, 3h, 230V AC	QAW423SC *	QAW423SC-SI*	3 h	29,7 W - 250 lm	3,2V/3,3Ah LiFePO4
LED, 8h, 230V AC	QAW428SC *	QAW428SC-SI*	8 h	29,7 W - 125 lm	3,2V/3,3Ah LiFePO4
SELF-CONTAINED LUMINAIRES WITH WIRELESS PROFESSIONAL MODUL			(lm in battery operation)		
LED, 1h, 230V AC	QAW421WL *	QAW421WL-SI*	1 h	30 W - 250 lm	3,2V/3,3Ah LiFePO4
LED, 3h, 230V AC	QAW423WL *	QAW423WL-SI*	3 h	30 W - 250 lm	3,2V/3,3Ah LiFePO4
LED, 8h, 230V AC	QAW428WL *	QAW428WL-SI*	8 h	30 W - 125 lm	3,2V/3,3Ah LiFePO4
LUMINAIRES FOR CENTRAL BATTERY SYSTEMS AC/DC			(lm in battery operation)		
LED, 230V AC/DC	QAW009 *	QAW009-SI*	CPS	26 W - 2300 lm	
LUMINAIRES FOR CENTRAL BATTERY SYSTEMS AC/DC INCL. MONITORING MODULE			(lm in battery operation)		
LED, 230V AC/DC	QAW009ML *	QAW009ML-SI*	CPS	26 W - 2300 lm	
LED, 230V AC/DC	QAW029ML *	QAW029ML-SI*	CPS	30,6 W - 360 lm	

\* Also available with an integrated HF motion sensor. It switches the luminaire only in mains operation. Add -BM at the end of the order number.

## WALL- ODER CEILING MOUNTING

Dimensions QAW

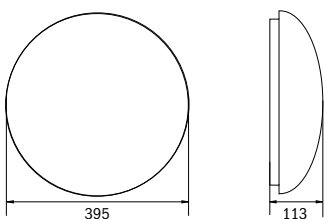

All Dimensions in mm



**QBW**

GENERAL PURPOSE AND EMERGENCY LIGHTING



## FACTS

- Plastic housing, white
- IP44
- 17W LED with 1.800lm luminous flux in mains mode
- SelfContained: -5° to +40°C  
Central battery: -30° to +40°C

Round plastic luminaire for general lighting and illumination of escape and rescue routes according to DIN EN 60598-1, DIN EN 60598-2-22 and DIN EN 1838.

Robust and timeless design, suitable for indoor use. The emergency light LED can be unfolded tool-free during assembly e.g. for optimally illumination of the escape and rescue routes especially for wall mounting.

<b>SELF-CONTAINED LUMINAIRES WITH SELFCONTROL MODULE</b>				(lm in battery operation)			
LED, 1h, 230V AC	QBW021SC	1 h	19 W - 470 lm	4,8V/2,0Ah NiMH			
LED, 3h, 230V AC	QBW023SC	3 h	19 W - 235 lm	4,8V/2,0Ah NiMH			
LED, 8h, 230V AC	QBW028SC	8 h	19 W - 110 lm	4,8V/2,0Ah NiMH			
<b>LUMINAIRES FOR CENTRAL BATTERY SYSTEMS AC/DC</b>				(lm in battery operation)			
LED, 230V AC/DC	QBW009	CPS	17 W - 1800 lm				
<b>LUMINAIRES FOR CENTRAL BATTERY SYSTEMS AC/DC INCL. MONITORING MODULE</b>				(lm in battery operation)			
LED, 230V AC/DC	QBW029ML	CPS	19 W - 470 lm				

## WALL- ODER CEILING MOUNTING

Dimensions QBW

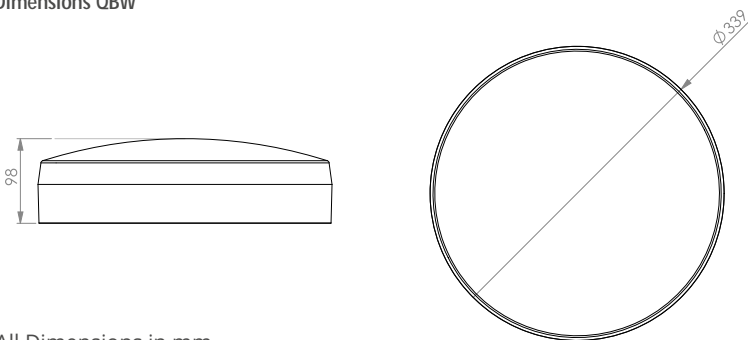

All Dimensions in mm

Distance table QBW009 for plane emergency routes

Mounting height (m)					
2.00	4.63	11.32	11.28	11.23	4.60
2.50	5.79	14.15	14.10	14.04	5.75
3.00	6.95	16.99	16.92	16.85	6.90
3.50	7.71	18.90	18.82	18.75	7.66
4.00	8.13	20.00	19.92	19.85	8.07



**QCW**

GENERAL PURPOSE AND EMERGENCY LIGHTING



## FACTS

- Zinc die-cast housing, white or anthracite
- IP54
- 17W LED with 1.600lm luminous flux in mains mode
- Self-Contained: -5° to +40°C  
Central battery: -30° to +40°

Round die-cast aluminum luminaire for general lighting and illumination of escape and rescue routes according to DIN EN 60598-1, DIN EN 60598-2-22 and DIN EN 1838.

Robust and timeless design, suitable for indoor and outdoor use. The emergency light LED can be unfolded tool-free during assembly e.g. for optimally illumination of the escape and rescue routes especially for wall mounting.

SELF-CONTAINED LUMINAIRES WITH SELFCONTROL MODULE		(lm in battery operation)			
LED, 1h, 230V AC	QCW021SC	QCW021SC-AZ	1 h	19 W - 470 lm	4,8V/2,0Ah NiMH
LED, 3h, 230V AC	QCW023SC	QCW023SC-AZ	3 h	19 W - 235 lm	4,8V/2,0Ah NiMH
LED, 8h, 230V AC	QCW028SC	QCW028SC-AZ	8 h	20 W - 210 lm	9,6V/2,0Ah NiMH
LUMINAIRES FOR CENTRAL BATTERY SYSTEMS AC/DC		(lm in battery operation)			
LED, 230V AC/DC	QCW009	QCW009-AZ	CPS	17 W - 1600 lm	
LUMINAIRES FOR CENTRAL BATTERY SYSTEMS AC/DC INCL. MONITORING MODULE		(lm in battery operation)			
LED, 230V AC/DC	QCW029ML	QCW029ML-AZ	CPS	19 W - 470 lm	

## WALL- OR CEILING MOUNTING

Dimensions QCW

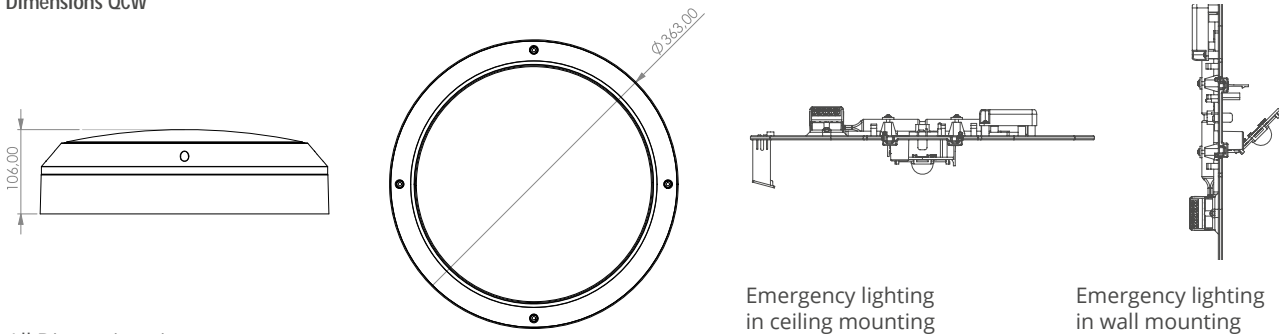

All Dimensions in mm

Distance table QCW009 for plane emergency routes

Mounting height (m)					
2.00	4.47	10.86	10.75	10.65	4.40
2.50	5.59	13.57	13.44	13.31	5.50
3.00	6.71	16.29	16.13	15.98	6.60
3.50	7.52	18.30	18.13	17.96	7.40
4.00	7.94	19.42	19.25	19.09	7.82



**LFD**

GENERAL PURPOSE AND EMERGENCY LIGHTING





## FACTS

- Glass fiber reinforced polyester, grey
- Acrylic glass prismatic transparent
- IP65
- Wall or ceiling mounting
- -5°C to +40°C

Combined LED general and emergency luminaire for illuminating escape and rescue routes according to DIN EN 60598-1, DIN EN 60598-2-22 and DIN EN 1838.

The robust LED wall and ceiling luminaire made of glass fiber reinforced polyester for wet room applications is suitable for illuminating storage areas, car parks etc. In mains operation, the luminaire provides up to 7.000lm. External mounting brackets facilitate installation.

<b>SELF-CONTAINED LUMINAIRES WITH SELFCONTROL MODULE</b>					
LED, 3h, 230V AC	LFD12003SC-NW	3 h	40 W - 500 lm	3,2V/4,5Ah LiFeP04	
LED, 3h, 230V AC	LFD15003SC-NW	3 h	55 W - 500 lm	3,2V/4,5Ah LiFeP04	
<b>LUMINAIRES FOR CENTRAL BATTERY SYSTEMS AC/DC</b>					
LED, 230V AC/DC	LFD12009-NW	CPS	36 W - 4500 lm		
LED, 230V AC/DC	LFD15009-NW	CPS	54 W - 7000 lm		
<b>LUMINAIRES FOR CENTRAL BATTERY SYSTEMS AC/DC INCL. MONITORING MODULE</b>					
LED, 230V AC/DC	LFD12009ML-NW	CPS	38 W - 4500 lm		
LED, 230V AC/DC	LFD15009ML-NW	CPS	56 W - 7000 lm		

Versions with 1h und 8h in development.

## WALL- OR CEILING MOUNTING

Dimensions LFD

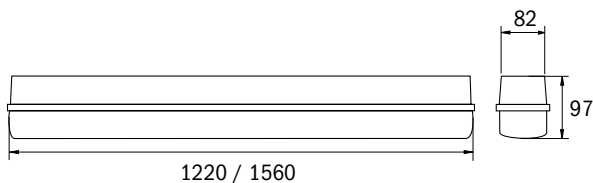

All Dimensions in mm

Distance table LFD15003SC for plane emergency routes (additional distance tables on our website)

Mounting height (m)					
2.00	4.32	10.66	10.16	9.66	4.00
2.50	4.70	11.68	11.16	10.64	4.35
3.00	4.99	12.54	12.01	11.47	4.64
3.50	5.23	13.27	12.72	12.17	4.86
4.00	5.40	13.89	13.34	12.78	5.04



 **FLU**  
EMERGENCY ROUTE LIGHTING



### FACTS

- Zinc die-cast housing
- LED mit 10W, 30W or 50W
- IP66
- -25°C to +40°C

Robust ceiling-mounted Aluminium die-cast luminaire for the lighting of escape and rescue routes according to DIN EN 60598-1, DIN EN 605982-22 and EN 1838.

The IP66 flood light is suitable for indoor and outdoor use. Due to the wide beam angle, large areas can be easily illuminated. The MU05 monitoring module is installed in the supplied separate housing.



<b>LUMINAIRES FOR CENTRAL BATTERY SYSTEMS AC/DC INCL. MONITORING MODULE</b>				
10W, 230V AC/DC	FLU10ML	CPS	11,5 W - 1400 lm	
30W, 230V AC/DC	FLU30ML	CPS	31,5 W - 4200 lm	
50W, 230V AC/DC	FLU50ML	CPS	51,5 W - 7000 lm	

### WALL- OR CEILING MOUNTING

**FLU10ML**  
All Dimensions in mm

**FLU30ML**

**FLU50ML**

### ACCESSORIES



Dimensions MU05-BOX

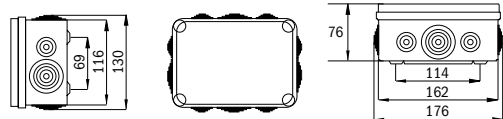



# ROPA – PREMIUM PANEL

GENERAL PURPOSE AND EMERGENCY LIGHTING



## FACTS

- LED 54W
- IP20
- For 620mm grid ceilings (For 600mm grid ceilings on request)
- 0°C to +40°C

The Premium LED panel for suspended ceilings offers you the highest brightness of approx. 4,500 lm at the best price. That's about 135 lm per watt!

The cover is made of PMMA plastic and therefore UV resistant which prevents yellowing.

The Premium LED Panel cleverly combines energy-saving general lighting with the prescribed emergency lighting.



<b>SELF-CONTAINED LUMINAIRES WITH SELFCONTROL MODULE</b>				
LED, 3h, 230V AC	ROPA4202SC	3 h	33 W - 660 lm	
<b>LUMINAIRES FOR CENTRAL BATTERY SYSTEMS AC/DC</b>				
LED, 230V AC/DC	ROPA4201	CPS	31 W - 4300 lm	
<b>LUMINAIRES FOR CENTRAL BATTERY SYSTEMS AC/DC INCL. MONITORING MODULE</b>				
LED, 230V AC/DC	ROPA4201ML	CPS	33 W - 4300 lm	

Distance table ROPA4201SC for plane emergency routes

Mounting height (m)					
2.00	3.80	8.73	4.64	7.79	3.84
2.50	4.13	10.22	5.11	8.49	4.17
3.00	4.38	10.98	11.05	11.12	4.44
3.50	4.57	11.63	11.71	11.78	4.63
4.00	4.71	12.17	12.25	12.33	4.77

# » WIRELESS BASIC & LIGHTLINX®

CONTROL AND MONITOR EMERGENCY LIGHTS COMFORTABLE BY APP



**Wireless Basic®** connects up to 50(\*) self-contained luminaires in a small emergency lighting system via Bluetooth Low Energy (BLE) to your Android Smartphone or Tablet. The luminaires communicate via BLE with each other and build a closed, safe Bluetooth Mesh Network. Each exit sign or emergency luminaire equipped with a **Wireless Basic®** module will report its current status and the results of the legally required regular tests to the Bluetooth-requesting mobile device. In addition, the results of the tests will be stored safely in the cloud based RP-Onlineportal LIGHTLINX® (www.Lightlinx.com).

The installation of the luminaires is done quick and easy, because there are no additional wires needed thanks to the Bluetooth radio modules.

In the **Wireless Basic®** app luminaires can be grouped and assigned to projects. The lights can also be switched or a test triggered via the Bluetooth interface.

As with the Wireless Professional, the individual luminaires also communicate with each other during the **Wireless Basic®** monitoring, thus increasing the range of the Bluetooth signal. If a mobile device is within range of a luminaire of a system, the data of all associated luminaires can be transmitted. This minimizes testing effort.

The wireless connection of the **Wireless Basic®** luminaires via BLE offers several advantages for smaller emergency lighting systems with up to 50 individual luminaires: minimal installation and maintenance effort, omission of a central control unit, cost-effective monitoring via app, secure storage of data and test protocols in the cloud.

In the current version, the app offers a central, noticeable display version of the current status to meet the pre-standard VDE V0108-100-1: 2018-12. The central mode ensures that the status of all luminaires registered in the network is displayed on a device that remains at the installation site.

The Wireless Basic App is available for download at Google Play store or Apple App store.

\* - Depending on the country of installation, further restrictions may be imposed by local regulations.

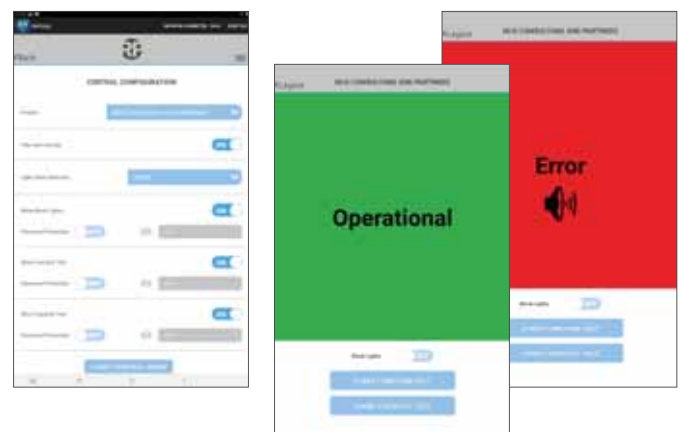

The central mode of the Wireless Basic App fulfills the Pre-standard VDE V0108-100-1: 2018-12

**LIGHTLINX®** 1 Error , 0 Warning , 1 Info

Startseite | Ordner und Projekte verwalten | APTTest Techniken | Abmelden | Deutsch

Alle

Projekte nach Status filtern: Alle Ok Info Warnung Fehler

Status	Projektname	Physikalische Zahl	Stadt	Zuletzt aktualisiert	Typ
Fehler	Demo Project	63110	Rodgau	24.01.2020, 16:57:34	WirelessBasic
Ok	Freies Project 1	63110	Rodgau	24.01.2020, 16:57:34	WirelessBasic
Ok	Freies Project 2	63110	Rodgau	24.01.2020, 16:57:34	WirelessBasic
Ok	Freies Project 3	63110	Rodgau	24.01.2020, 16:57:34	WirelessBasic
Info	Test Project	63110	Rodgau	24.01.2020, 16:57:34	WirelessBasic
Info	Test Project II	63110	Rodgau	24.01.2020, 16:57:34	WirelessBasic

The **Lightlinx®** Cloud gives the operator of emergency lighting systems an overview of the various installed systems and their status.

In the event of a malfunction, it is possible to react quickly and efficiently to ensure the operation of the system.

**Wireless Basic®** is currently available for luminaires of the following types:

- ASMU
- EA
- IL
- KM
- KMB
- KS
- ZAW

Further luminaire types are in preparation.

# » WIRELESS PROFESSIONAL

## WIRELESS LUMINAIRE MONITORING

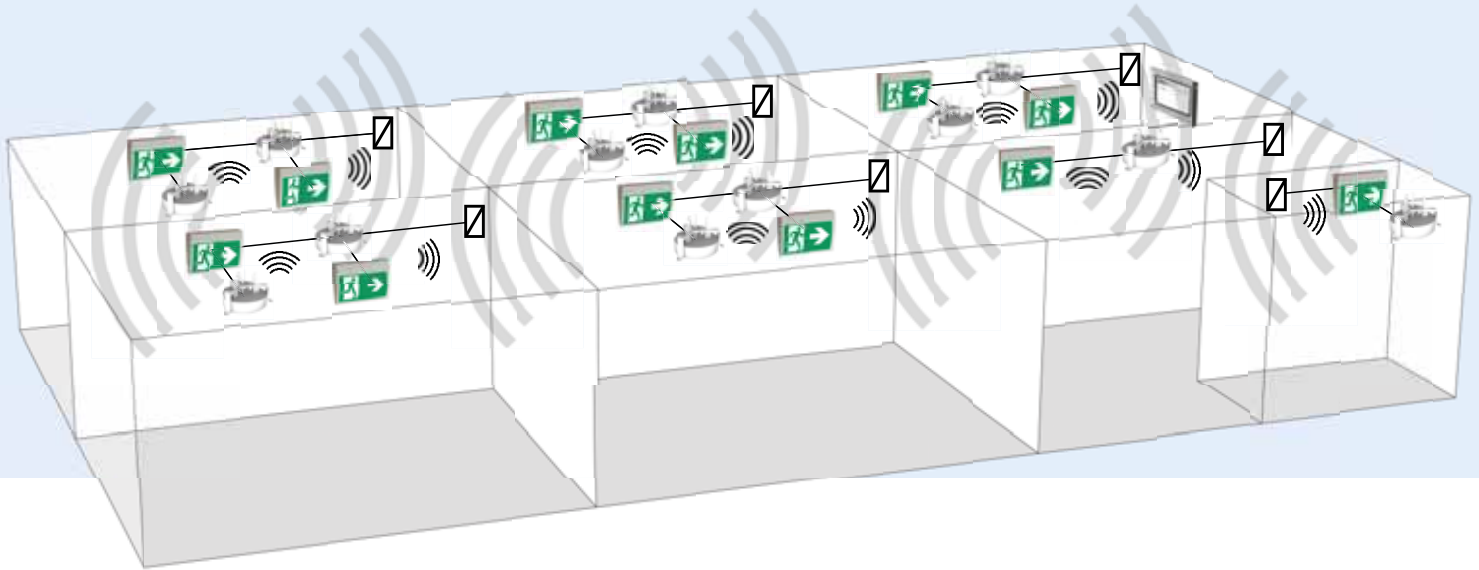

## NEXT GENERATION LUMINAIRE MONITORING AND CONTROL

With the new Wireless Professional the control and monitoring of self-contained emergency and security lighting is a snap! To install the lights the only thing necessary is a connection to a normal power supply with 230V AC. The subsequent installation of the wireless system for monitoring and controlling the luminaires is taking care of itself.

Each luminaire equipped with wireless professional may connect to other luminaires or the central unit on the European approved frequency of 868 MHz and report its own and the status of others through the system registered luminaires. The indoor range sums up to at least 30m. Thanks to the radio frequency of 868 MHz even a reinforced concrete ceiling between floors is no insurmountable barrier.

The wireless system can include 250 devices (sum of all luminaires, repeater and I/O boxes connected to the system) per central unit as standard and is expandable up to 1,000. Furthermore 5 timerfunctions and a networked system are possible by standard. The extent of functions can be expanded afterwards with a code within the software.

The radio system is organizing itself ad-hoc. Each Wireless Professional luminaire automatically contacts all reachable nodes: other luminaires, repeaters or the central control unit itself. By networking of several central units the 1,000 luminaire limit can be exceeded.

The software for the central unit is available in several languages, allows the storage of building maps and can be installed on an existing Windows system. The registered luminaires can be placed on the digital floor map and appear with their current status.

Many of the available Wireless Professional luminaires can be switched by radio. A timetable stored in the central unit makes it possible to put the emergency lights in an unused building at the weekend in standby mode. Thus, the Wireless Professional saves energy and even the security is guaranteed at all times.

Wireless Professional lights are very inconspicuous. Even in stainless steel or aluminum cases the radio technology works without any visible antennas.





## WIRELESS PROFESSIONAL - ADVANTAGES AT A GLANCE

- Easy installation – only 230V AC needed
- Self-organizing ad-hoc wireless system
- Range between luminaires guaranteed 30m inside buildings (even through a concrete ceiling)
- Europe conform frequency of 868 MHz
- Up to 4 times higher range than 2.4 GHz-Systems
- Resistant to DECT, Bluetooth and WLAN signals
- 250 devices per system (expandable in steps of 250 up to 1,000 per system)
- 5 Timerfunctions (expandable in steps of 10)
- 1 networking system (expandable in steps of 5)
- Multi-language easy to use software
- No visible antenna on the luminaires
- Many luminaires can be switched via timetable
- Status and error reports are delivered to the system via E-Mail administrator
- Log for daily/weekly function test stored in the central unit
- Capacity test (also in groups) of the battery for the whole operating time (usually 3h) possible
- Repeater for range extension
- Switching of luminaires between non-maintained and maintained mode by software
- No faulty connection – no BUS-line
- Polarised
- Monitoring system according to EN 62034 Type ER



### WLZENT 01

The Wireless Professional control centre developed for industrial use is based on a Linux Embedded PC. The functional, service-friendly wall-mounted housing with touch screen can be installed directly at a permanently manned location. Thus, all functions and system information of your Wireless Professional installation are available at your fingertips.

# » WIRELESS PROFESSIONAL

## WIRELESS LUMINAIRE MONITORING

### WIRELESS PROFESSIONAL CENTRAL - AVAILABLE VERSIONS

Version	Order number	Scope of delivery
USB-Coordinator (1x needed per system)	WLKOR3	USB-Coordinator incl. Wireless Professional Software for connection to an existing Windows®-System; pre-programmed for up to 250 luminaires
Linux-Industrial-PC incl. WirelessProfessional Software	WLZENT01	Industrial-PC, Touchdisplay, incl. USB Koordinator und Wireless Professional Software for up to 250 Luminaires
Linux-Industrial-PC incl. WirelessProfessional Software	WLZENT01-500	Industrial-PC, Touchdisplay, incl. USB Koordinator und Wireless Professional Software for up to 500 Luminaires
Linux-Industrial-PC incl. WirelessProfessional Software	WLZENT01-750	Industrial-PC, Touchdisplay, incl. USB Koordinator und Wireless Professional Software for up to 750 Luminaires
Linux-Industrial-PC incl. WirelessProfessional Software	WLZENT01-1000	Industrial-PC, Touchdisplay, incl. USB Koordinator und Wireless Professional Software for up to 1000 Luminaires
System extension networking	WLCODE-S5	Software license for additional 5 networking systems
Repeater	WLREP1-IP20	Repeater for range extension in areas with bad reception, IP20 housing
Repeater	WLREP2-IP54	Repeater for range extension in areas with bad reception, IP54 housing
Wireless Embedded PC for 250 Luminaires	WLCPC2	Wireless Professional Compact PC, DIN rail mounting 5TE Embedded, incl. WL Software, mains supply, USB-Coordinator (WLCPC1 can assign 250 luminaires)
Wireless Embedded PC	WLCPC2.OK	Wireless Professional Compact PC, DIN rail mounting 5TE Embedded, incl. WL Software, mains supply, <b>without USB-Coordinator</b> (WLCPC2.OK can assign 250 luminaires)



Wireless Embedded PC

# » WIRELESS IO-BOX



## FACTS

- 1 potential-free combined fault indication contact
- 2 potential-free programmable contacts
- 2 programmable galvanically isolated inputs
- Reverse polarity tolerant inputs
- Special fire alarm function integrated
- 24V DC auxiliary voltage output

Art.-No.: WLIO32

The IO-box is an interface module of the automatic test and control system for emergency lighting Wireless Professional, whose inputs and outputs signalise states and conditions of and to the test and control system. The IO-box has 3 outputs in form of potential-free changeover contacts, of which contact 1 is used for a system disturbance combined fault indication. The other two contacts can be programmed by means of the Wireless Professional software, in order to signalise various system states such as last test - failure, and operating status or switch single luminaires or groups. An LED is allocated to each output relay which signalises whether the relay is triggered.

Furthermore, there are 2 galvanically isolated switch inputs to integrate control and/or sensor signals of e.g. an external test pushbutton or a key switch. An LED is allocated to each input to signalize that a switch voltage is applied to it. The IO-box has an auxiliary voltage output which provides an auxiliary voltage that can be used to energize the inputs. The auxiliary voltage can be used as shown in the connection example.

The IO-box is designed for mounting on a hat rail in a switching cabinet. The information transfer from the IO-box to the Wireless Professional centre is wireless. IO Box is able to switch luminaires regardless of the central unit.

## DIMENSIONS AND CONNECTION EXAMPLE

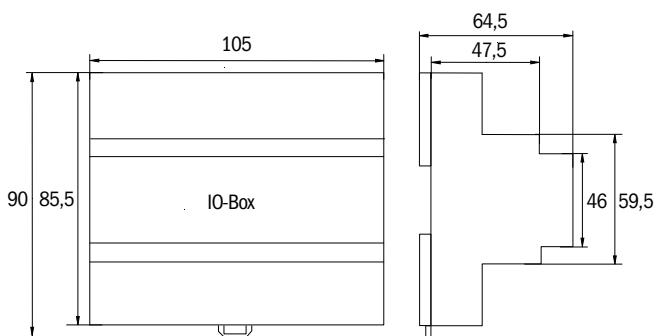

All Dimensions in mm

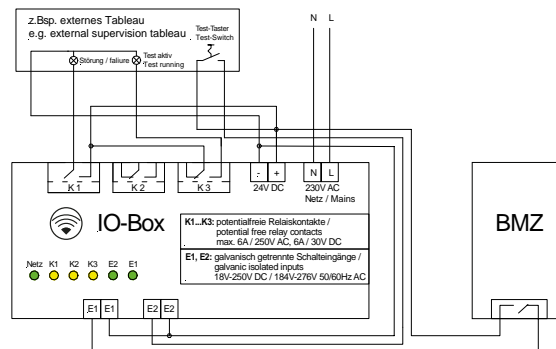

# » ACCESSORIES

Name	1PW	1PV	2PW	2PV	2DW	2DS	DSA / DSA2 / DSA3 / DSA4
Colour	white	chrom	white	chrom	white	silver	silver
Standard length	50 cm	50 cm	50 cm	50 cm	50 cm	50 cm	1,5 m / 3m / 5m / 8m
Optional length	1 m / 2m	1 m / 2m	1 m / 2m	1 m / 2m	1 m / 2m	1 m / 2m	-
Material	Steel pipe	Steel pipe	Steel pipe	Steel pipe	Steel pipe	Steel pipe	Steel rope
Suitable for	WK, WG, WX,	WK, WG, WX,	LM, LX, LS, KB, KX, KS, KM, KC, KD, KL, KW, PF, KE	LM, LX, LS, KB, KX, KS, KM, KC, KD, KL, KW, PF, KE, AS	LM, LX, LS, KB, KX, KS, KM, KC, KD, KL, KW, PF, KE	LM, LX, LS, KB, KX, KS, KM, KC, KD, KL, KW, PF, KE	LM, LX, LS, KB, KX, KS, KM, KC, KD, KL, KW, PF, KE, AS

Please specify: Art.-No. -EB: Self-Contained 4-pole / - AC: 3-pole, wired

Pendulum / Cord suspension

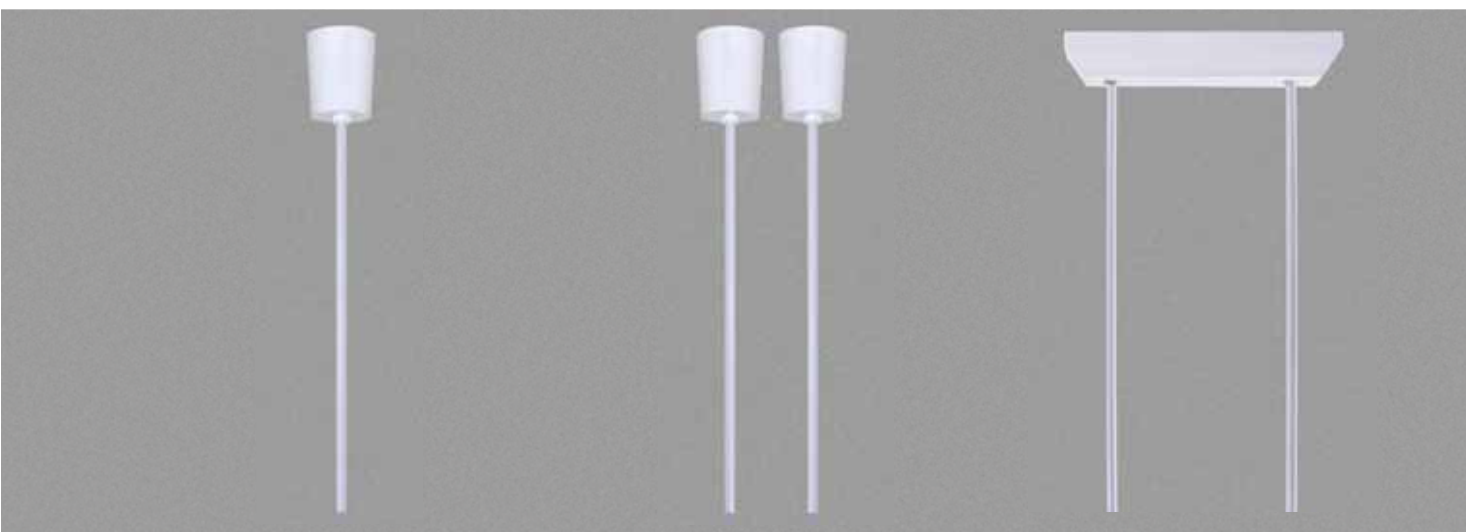

1PW

2PW

2DW /2DS

Wall bracket

Wall bracket



AWM AWX

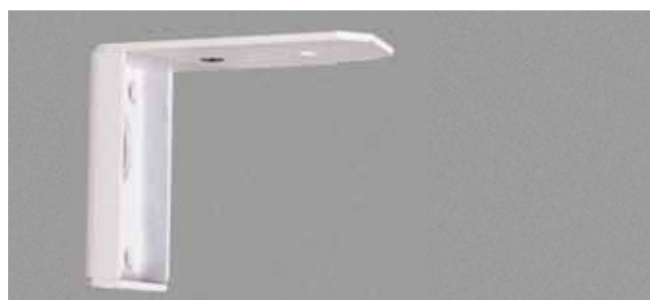

AWM suitable for:  
RM, RI, LM, ASU, KT

AWKSU suitable for:  
KS, KM, KT

# » BALL PROTECTION

## STEEL, POWDER COATED

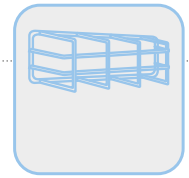

Suitable for luminaire types:  
KD / KM / KS / LI / LM / SD / VM

Dimensions:  
B x H x T 320 x 220 x 120 mm

Drilling distances:

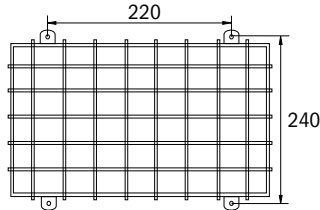

**BALL1**

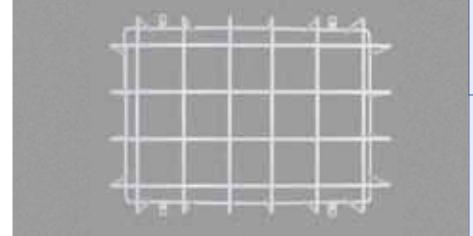

Suitable for luminaire types:  
KC / KL / LX / PF

Dimensions:  
B x H x T 450 x 280 x 125 mm

Drilling distances:

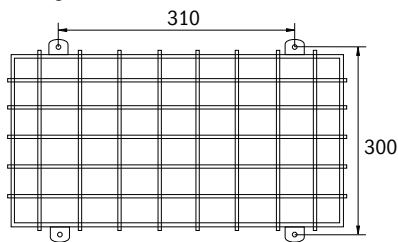

**BALL2**

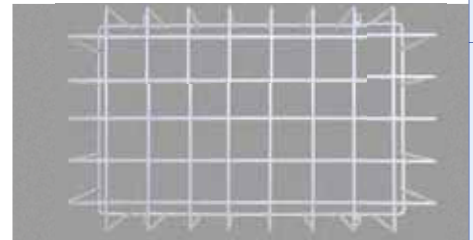

Suitable for luminaire types:  
IL, KI, VI, RI, KT, DAQ, DAR

Dimensions:  
B x H x T 200 x 200 x 80 mm

Drilling distances:

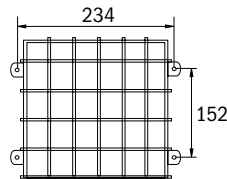

**BALL3**

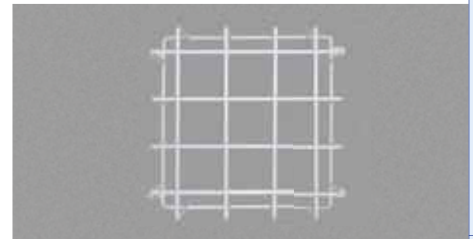

Suitable for luminaire types:  
KW

Dimensions:  
B x H x T 420 x 170 x 170 mm

Drilling distances:

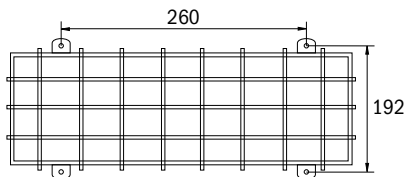

**BKW**

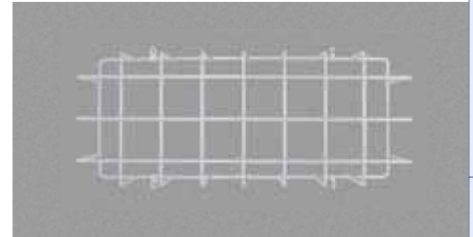



 **BALL PROTECTION**  
POLYCARBONATE, TRANSPARENT

## POLYCARBONATE BALL PROTECTION

290 x 210 x 77mm

Art.-No. BALLPLX-AM

Suitable for luminaires of types:  
**AM**

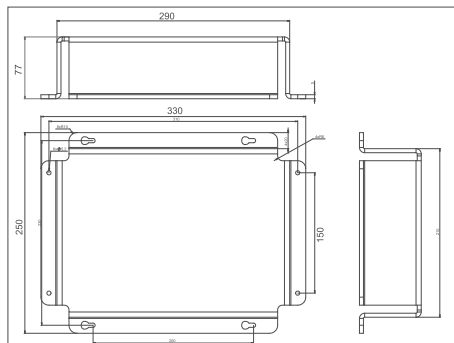

## POLYCARBONATE BALL PROTECTION

390 x 250 x 88mm

Art.-No. BALLPLX-AX

Suitable for luminaires of types:  
**AX, KC**

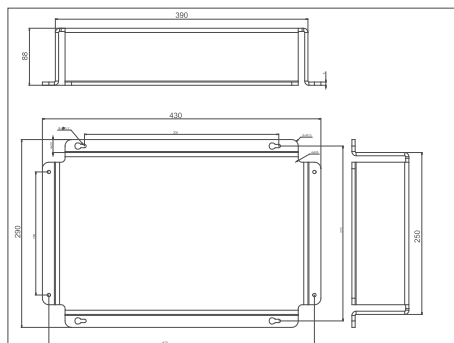

## POLYCARBONATE BALL PROTECTION

370 x 140 x 77mm

Art.-No. BALLPLX-KBU

Suitable for luminaires of types:  
**KBU**

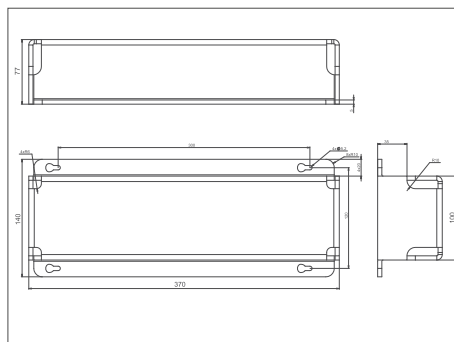

## POLYCARBONATE BALL PROTECTION

370 x 282 x 77mm

Art.-No. BALLPLX-KBS

Suitable for luminaires of types:  
**KB incl. KBG (KBM / KBK)**

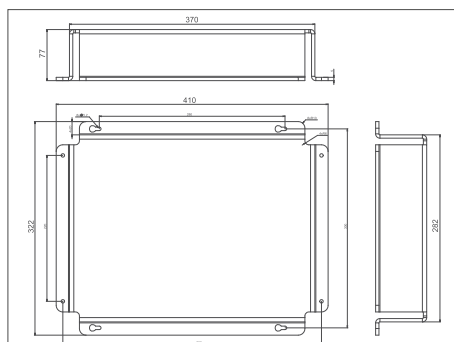

## POLYCARBONATE BALL PROTECTION

415 x 171 x 31mm

Art.-No. BALLPLX-KBE

Suitable for luminaires of types:  
**KBU in Recessed frame KBE**

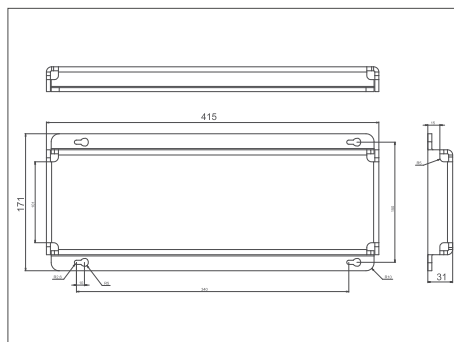

GENERAL  
INFORMATIONS

DESIGN LUMINAIRES

DYNAMIC  
LUMINAIRES

UNIVERSAL  
LUMINAIRES

INDUSTRIAL  
LUMINAIRES

GENERAL LIGHTING  
WITH EMERGENCY LIGHT

WIRELESS MONITORING

ACCESSORIES

MODULES

# » BALL PROTECTION

## POLYCARBONATE, TRANSPARENT

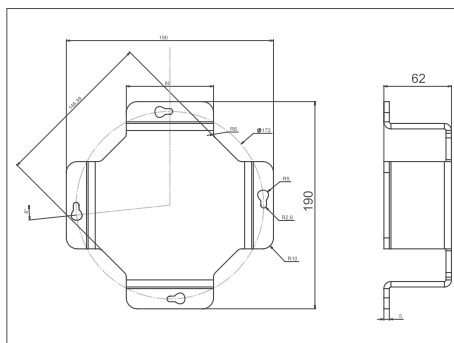

### POLYCARBONATE BALL PROTECTION

190 x 190 x 62mm

Art.-No. BALLPLX-ILD

Suitable for luminaires of types:  
**ILDx**  
**EAR / EAQ**

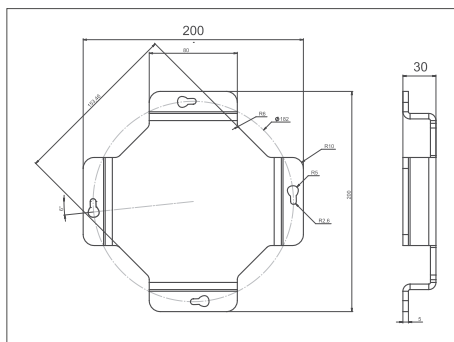

### POLYCARBONATE BALL PROTECTION

200 x 200 x 30mm

Art.-No. BALLPLX-ILE

Suitable for luminaires of types:  
**ILEx**  
**EE**

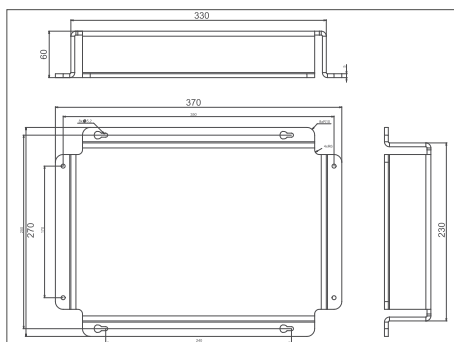

### POLYCARBONATE BALL PROTECTION

330 x 230 x 60mm

Art.-No. BALLPLX-KMU

Suitable for luminaires of types:  
**KMU, KSU, KSC**

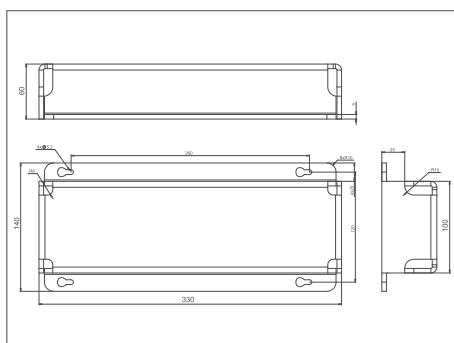

### POLYCARBONATE BALL PROTECTION

330 x 100 x 60mm

Art.-No. BALLPLX-KMB

Suitable for luminaires of types:  
**KMB**



## POLYCARBONATE BALL PROTECTION

370 x 270 x 100mm

Art.-No. BALLPLX-KD

Suitable for luminaires of types:  
KD

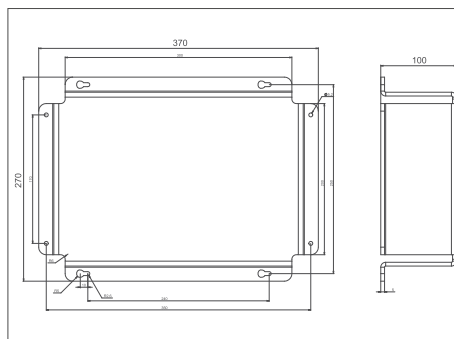

## POLYCARBONATE BALL PROTECTION

413 x 183 x 112mm

Art.-No. BALLPLX-KWW

Suitable for luminaires of types:  
KW

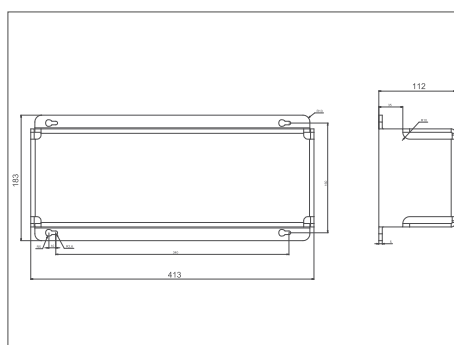

## MOUNTING RECOMMENDATION

Stone or concrete wall: Dowel 8mm, Screw 5,5mm

Wood: Screw 5,5 x 35mm

# » MLED 500 / NT24

## EMERGENCY LIGHT MODULES CENTRAL BATTERY SYSTEMS



The **MLED500** is an electronic switching power supply with integrated individual light monitoring, light management function, mains monitoring, dimmer and flashing functions. All switching modes are possible. The mains monitor allows the operation of connected luminaires in non-maintained mode in a maintained circuit. In case of a mains failure all lights are switched on automatically. LED illuminants with a max. output of 8W can be used as consumers.

The MLED500 is also capable of dimming the lights to 30% or 50% in mains operation and to execute a flashing function in emergency operation.

The MLED500 is suitable for use with emergency lighting systems of the MC series.



### **NT24: Switch-mode power supply up to 5W for LED lights**

Set-up of various output voltages (3.3V/5V/12V/24V) possible.

The NT24 power supply can be used in conjunction with a monitoring module for use in emergency light systems of the MC series. The respective output voltage is set via the switch.

# » LPU / LEM / LEX / WRLED

## SELF-CONTAINED EMERGENCY LIGHT MODULES

The **LPU** is a microprocessor-controlled self-contained emergency lighting unit for LED luminaires with 1-5W ERT modules, 5 to 11-fold low-power or 12V LED Strip LED modules. The operating time can be chosen between 1, 3 or 8 hours - depending on the capacity of the battery. In a 3 - or 8-hour operation, the lamp may operate in dimmed mode. The LED supply is equipped with connector for up to two 4.8 V batteries.

LPU meets the requirements acc. to EN 60598-2-22 and DIN VDE 0108 (deep discharge, lock-out and switching). In addition, the LPU is equipped with Self-Control (SC) function. All switching modes (including dimming and flashing function) are possible. Blocking of emergency operation is possible via the built-in Ff contact by 6-12V DC.

The **LEM** is a self-contained emergency lighting module intended for use on LED lights with 1x1W ERT or 8 to 11-fold low power LED strips.

externally connected test button (adhesive pad). A charge indicator LED is also integrated into this pad. This accurately displays the battery charge. Expandable with SELF-CONTROL, BUS-CONTROL and Wireless Professional.

The technical configuration of the LEM complies with EN 60598-2-22 and DIN VDE 0108 (deep discharge protection, restart interlock and switch-over device). A functionality test is possible at any time with the

The **LEX** (LED supply module) is intended for use with LED lights with a max. 4W output (e.g. 12V LED disc or LED strip). The technical configuration of the LEX complies with requirements per DIN EN 60598-2-22 and DIN VDE 0108 (deep discharge protection, restart interlock and switch-over device).

The LED lights that are connected to the LEX can be operated as switched lights, maintained lights or as non-maintained lights. It is possible to operate the connected lights whilst dimmed in maintained operation via the integrated cinema switching. The light intensity here equates to approx. 12.5% of the standard light intensity.

**WRLED...(-Box)** for LED panels and downlights combines the electronics with an accumulator in the same housing for easy installation in confined spaces. Strain relief and wires led out make work easier for the installer. A microprocessor automatically adjusts the LED current to the connected luminaire and the battery used, thus providing maximum illuminance throughout the emergency operating period.

During regular mains operation, the LED array is supplied by the LED driver. During emergency operation, the power is supplied by the rechargeable battery installed in the Emergency Box.

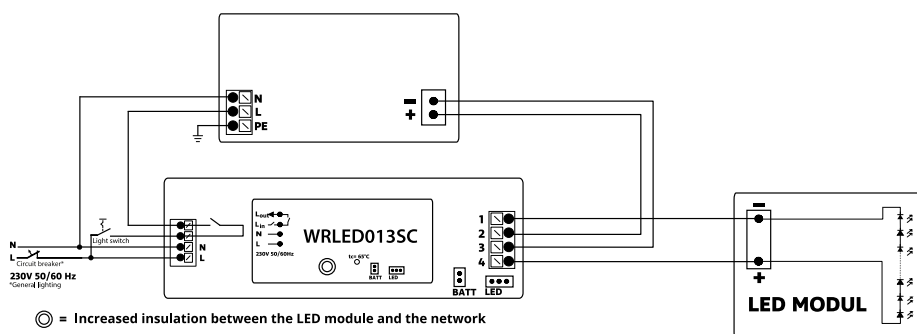



 **NVG**  
SELF-CONTAINED POWER SUPPLY

IP54

Ausgang  
230V/50HzGENERAL  
INFORMATIONS

## FACTS

- Steelsheet or PC housing
- IP54
- Wall mounting
- -5°C to +40°C

Emergency power supply with output voltage: 230V / AC by an inverter. 2-wire-system up to max. 500 m distance. Single and double supply luminaire with the available illuminants: florescent lamps, filament lamps and LED at 100% luminous flux.

Technical specifications according to DIN EN 60598-2-22. With deep discharge protection and integrated switch-on-lock, treshold switch. The Power is provided by maintenance-free long-life and gas-proof Pb rechargeable batteries. The full electronic and time guided charging extends the battery life. The operational state and fails are shown by the LED function monitor. It is possible to manually activate a test via the build in test switch (not on WL).

DESIGN LUMINAIRES

DYNAMIC  
LUMINAIRESUNIVERSAL  
LUMINAIRESINDUSTRIAL  
LUMINAIRESGENERAL LIGHTING  
WITH EMERGENCY LIGHT















WIRELESS MONITORING

ACCESSORIES

MODULES



## SELF-CONTAINED POWER SUPPLY

Order number	Housing	Dimensions	Output (inkl. 20% Reserve)			Ingress Protection	Protection class	Battery	
			1h	3h	8h				
<b>SELF-CONTAINED SUPPLY INCL. SELF-CONTROL MODULE</b>									
NVKS203SC	Steelsheet	120 x 300 x 300 mm	-	20 W	-	IP54	1	OGIV1290LP, AGM Battery 12V 9Ah	
NVKS403SC	Steelsheet	120 x 300 x 300 mm	-	40 W	-	IP54	1	OGIV12170LP, AGM Battery 12V 17Ah	
NVGS653SC	Steelsheet	210 x 400 x 500 mm	-	65 W	-	IP54	1	OGIV12280L, AGM Battery 12V 28Ah	
NVGS903SC	Steelsheet	210 x 400 x 500 mm	-	90 W	-	IP54	1	OGIV12400LP, AGM Battery 12V 40Ah	
NVGK203SC	PC	230 x 265 x 540 mm	-	20 W	-	IP54	2	OGIV1290LP, AGM Battery 12V 9Ah	
NVGK403SC	PC	230 x 265 x 540 mm	-	40 W	-	IP54	2	OGIV12170LP, AGM Battery 12V 17Ah	
NVGK653SC	PC	230 x 265 x 540 mm	-	65 W	-	IP54	2	OGIV12280L, AGM Battery 12V 28Ah	
NVGK903SC	PC	230 x 265 x 540 mm	-	90 W	-	IP54	2	OGIV12400LP, AGM Battery 12V 40Ah	
<b>SELF-CONTAINED SUPPLY WITH WIRELESS PROFESSIONAL MODULE</b>									
NVKK451WL	PC	120 x 300 x 300 mm	45 W	-	-	IP54	2	OGIV1290LP, AGM Battery 12V 9Ah	
NVGK451WL	PC	230 x 265 x 540 mm	45 W	-	-	IP54	2	OGIV1290LP, AGM Battery 12V 9Ah	
NVKK601WL	PC	120 x 300 x 300 mm	60 W	-	-	IP54	2	OGIV12170LP, AGM Battery 12V 17Ah	
NVGK1051WL	PC	185 x 280 x 570 mm	105 W	-	-	IP54	2	OGIV12170LP, AGM Battery 12V 17Ah	
NVGK1301WL	PC	230 x 265 x 540 mm	130 W	-	-	IP54	2	OGIV12280L, AGM Battery 12V 28Ah	
NVGK2101WL	PC	230 x 265 x 540 mm	210 W	-	-	IP54	2	OGIV12400LP, AGM Battery 12V 40Ah	
NVKK203WL	PC	120 x 300 x 300 mm	-	20 W	-	IP54	2	OGIV1290LP, AGM Battery 12V 9Ah	
NVGK203WL	PC	230 x 265 x 540 mm	-	20 W	-	IP54	2	OGIV1290LP, AGM Battery 12V 9Ah	
NVKK403WL	PC	120 x 300 x 300 mm	-	40 W	-	IP54	2	OGIV12170LP, AGM Battery 12V 17Ah	
NVGK403WL	PC	230 x 265 x 540 mm	-	40 W	-	IP54	2	OGIV12170LP, AGM Battery 12V 17Ah	
NVGK653WL	PC	230 x 265 x 540 mm	-	65 W	-	IP54	2	OGIV12280L, AGM Battery 12V 28Ah	
NVGK903WL	PC	230 x 265 x 540 mm	-	90 W	-	IP54	2	OGIV12400LP, AGM Battery 12V 40Ah	
NVGK308WL	PC	230 x 265 x 540 mm	-	-	30 W	IP54	2	OGIV12280L, AGM Battery 12V 28Ah	

Order number	Housing	Dimensions	Output (inkl. 20% Reserve)			Ingress Protection	Protection class	Battery	
			1h	3h	8h				
SELF-CONTAINED SUPPLY WITH SWITCHABLE WIRELESS PROFESSIONAL MODULE									
NVKK451WLSE	PC	120 x 300 x 300 mm	45 W	-	-	IP54	2	OGIV1290LP, AGM Battery 12V 9Ah	
NVGK451WLSE	PC	230 x 265 x 540 mm	45 W	-	-	IP54	2	OGIV1290LP, AGM Battery 12V 9Ah	
NVKK601WLSE	PC	120 x 300 x 300 mm	60 W	-	-	IP54	2	OGIV12170LP, AGM Battery 12V 17Ah	
NVGK1051WLSE	PC	185 x 280 x 570 mm	105 W	-	-	IP54	2	OGIV12170LP, AGM Battery 12V 17Ah	
NVGK1301WLSE	PC	230 x 265 x 540 mm	130 W	-	-	IP54	2	OGIV12280L, AGM Battery 12V 28Ah	
NVGK2101WLSE	PC	230 x 265 x 540 mm	210 W	-	-	IP54	2	OGIV12400LP, AGM Battery 12V 40Ah	
NVKK203WLSE	PC	120 x 300 x 300 mm	-	20 W	-	IP54	2	OGIV1290LP, AGM Battery 12V 9Ah	
NVGK203WLSE	PC	230 x 265 x 540 mm	-	20 W	-	IP54	2	OGIV1290LP, AGM Battery 12V 9Ah	
NVKK403WLSE	PC	120 x 300 x 300 mm	-	40 W	-	IP54	2	OGIV12170LP, AGM Battery 12V 17Ah	
NVGK403WLSE	PC	230 x 265 x 540 mm	-	40 W	-	IP54	2	OGIV12170LP, AGM Battery 12V 17Ah	
NVGK653WLSE	PC	230 x 265 x 540 mm	-	65 W	-	IP54	2	OGIV12280L, AGM Battery 12V 28Ah	
NVGK903WLSE	PC	230 x 265 x 540 mm	-	90 W	-	IP54	2	OGIV12400LP, AGM Battery 12V 40Ah	
NVGK308WLSE	PC	230 x 265 x 540 mm	-	-	30 W	IP54	2	OGIV12280L, AGM Battery 12V 28Ah	

It is not necessary to state the operation time for Self-Control Versions! Nameplates for all possible operation times will be enclosed.

For Wireless Professional-Versions it is necessary to state the operation time because this is set by default on the radio chip. Not all types are suitable for 8h operation due to the charging unit.

With the NVK types, a load of less than 10W per output leads to the detection of a lamp fault. With the NVG types, a load of less than 18W per output leads to the detection of a lamp fault.

Dimensions small PC / steelsheet housing

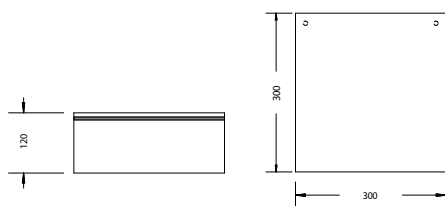

Dimensions large PC housing

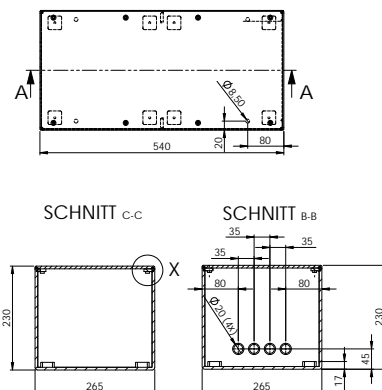

Dimensions large steelsheet housing

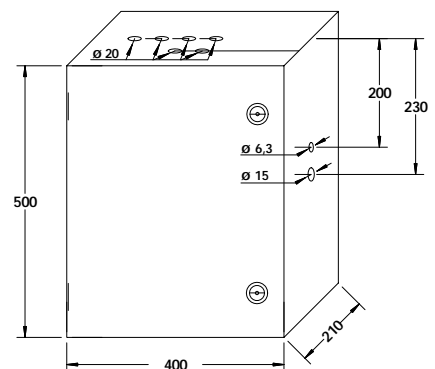

All dimensions in mm

## SECURITY IN ACCORDANCE WITH VALID STANDARDS

Our power supply systems are manufactured in cooperation with well-known partner companies according to ISO 9001 and in Germany.

Our plant manufacturing facility as well as selected systems of the multiControl plus series are certified by TÜV Rheinland.

Our power supply systems are developed, manufactured and tested in accordance with the applicable European and national installer standards as well as the applicable directives and electrotechnical requirements.

This applies in particular to:

- DIN EN 50171: 2001; Central power supply systems
- E DIN EN 50171: 2013; Central power supply systems
- DIN EN 50172: 2005; Emergency lighting systems
- DIN VDE 0100-718: 2005; Erection of low-voltage systems - Part 718: Requirements for business premises, rooms and systems of a special kind - Structural systems for gatherings of people
- DIN VDE 0100-560: 2013; Erection of low-voltage systems - Part 5-56: Selection and erection of electrical equipment - Equipment for safety purposes (IEC 60364-5-56: 2009, modified)
- DIN VDE 0100-600: 2008; Installation of low voltage systems - Part 6: Tests (IEC 60364-6: 2006, modified)
- DIN VDE V 0108-100-1: 2018-12; Emergency lighting systems
- DIN EN 50272-2 (VDE 0510-2): 2001-12; Safety requirements for batteries and battery systems - Part 2: Stationary batteries
- DIN EN 62034: 2013; Automatic test systems for battery-operated emergency lighting for escape routes (IEC 62034: 2012)

## OUR SAFETY POWER SUPPLY SYSTEMS

The systems of the multiControl plus series are battery-based safety power supply systems according to EN50171, which are designed for the supply and monitoring of exit sign and emergency luminaires. Up to 96 circuits per system enable the supply and additional line-free monitoring of up to 1920 lights.

The integration of commercially available lights (AC/DC compatible) is possible.

The circuit modules, which operate in AC / DC switchover mode, enable functions such as additional line-less individual light monitoring of up to 20 lights per circuit\*, mains monitoring\*, maintained, non-maintained or switched maintained luminaire. The mixed operation function\* for the operation of maintained and non-maintained lights as well as earth fault, overload and fuse monitoring is integrated in every circuit module.

The display and control unit, consisting of an LC display, keypad and status LEDs, provides information about the current system status and enables configurations directly on the system.

The test book records / stores data over a period of > 5 years. Each system has a BUS interface for connecting external switch request modules (SAM24), network monitors (MC-LM) and signaling and control panels (MCT-15).

A network monitor loop can be monitored on any system of the multiControl plus series, whereby all compact systems have an integrated CCIF for additional detection of clumping. The CCIF is optionally available for the multiControl plus.

Each IOM manages up to 4 freely programmable inputs, e.g. for monitoring functions. The multiControl plus and MDC systems offer the option of connecting up to 5 IO modules in order to implement further messages.

All systems of the multiControl plus series can be visualized and configured via an integrated (patented) web interface.

\* not MDC





## FROM LOW POWER SYSTEMS TO CENTRAL BATTERY SYSTEMS

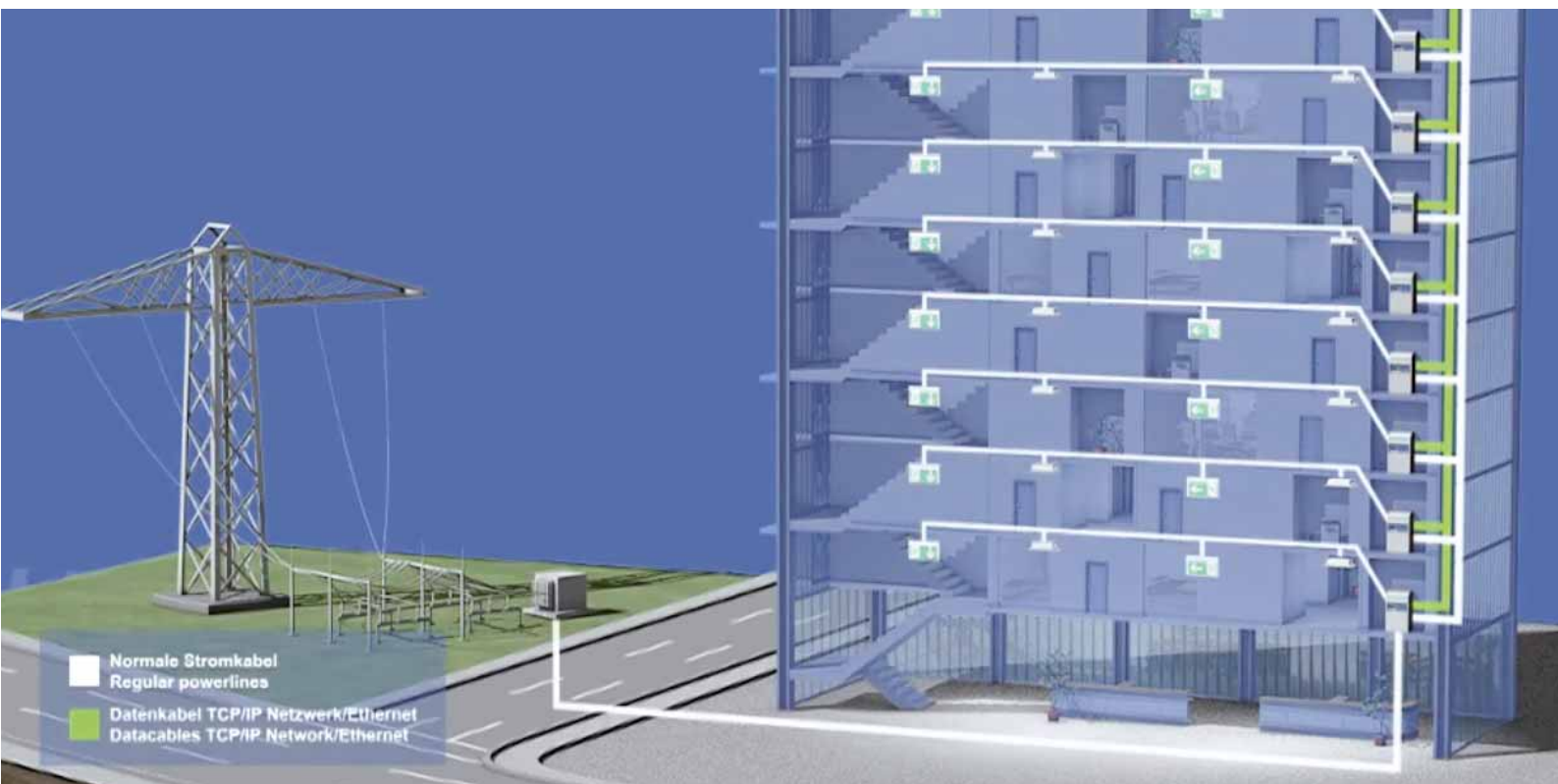

Power supply systems with limited output form the concept of decentralization of fire compartment-related safety lighting systems to supply emergency and safety lights in the fire compartment. This decentralized concept makes the use of cables in the maintenance of functions, for supplying the lights, superfluous according to MLAR 2005. Low power systems are approved up to an output power of 1500 W.

Despite decentralized systems, central monitoring and visualization via TCP / IP addressing of the entire system, consisting of up to 33 networked systems, is possible.



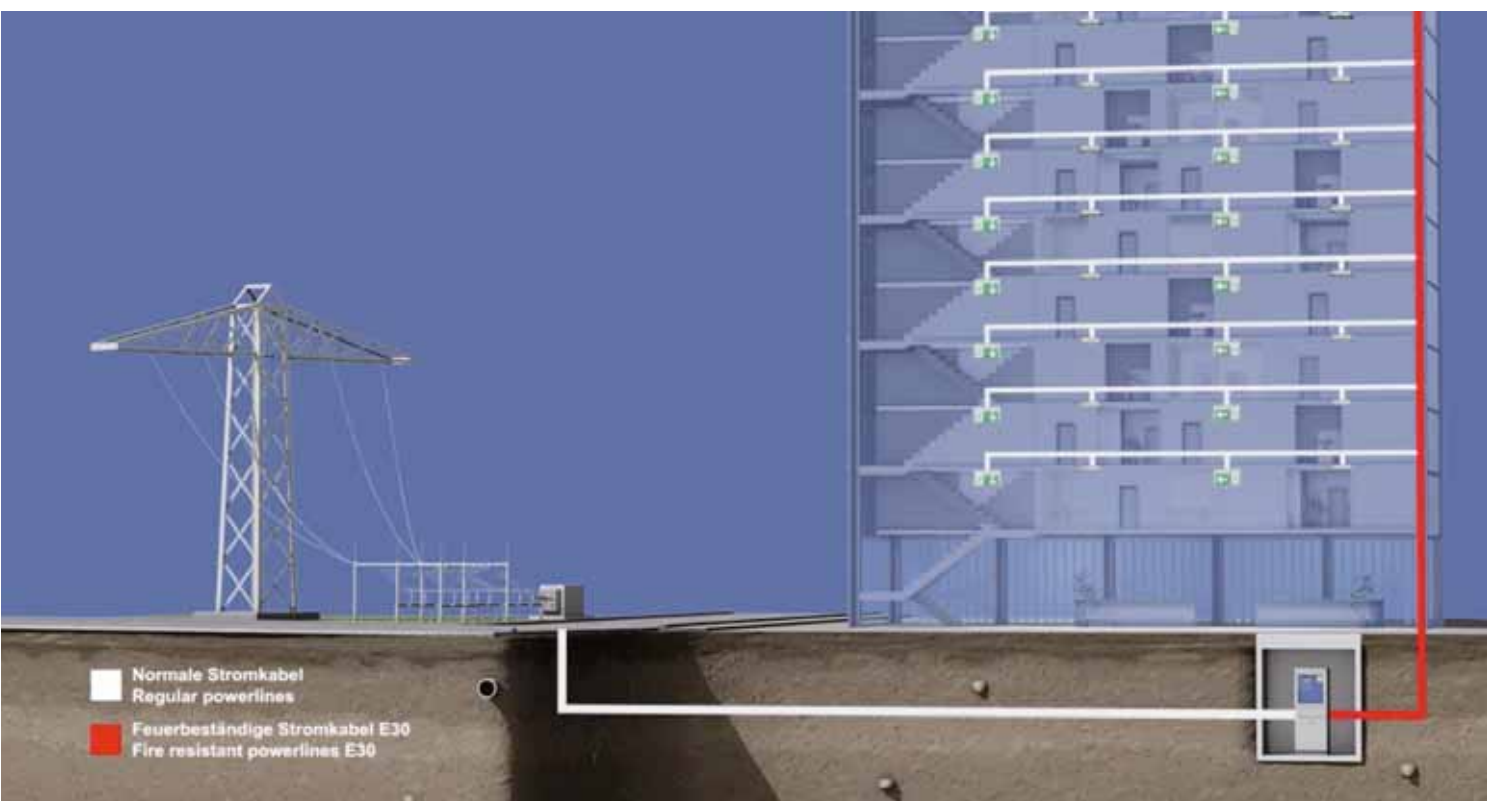

LOW POWER SYSTEMS

CENTRAL BATTERY SYSTEMS

SUBSTATIONS AND  
SUBDISTRIBUTIONS

ACCESSORIES AND MODULES

BATTERIA AND  
BATTERY MONITORING

Central Battery Systems without power limitation form the concept of cross-fire compartment safety lighting systems for the supply of exit signs and emergency lights from a central point. The individual fire compartments are supplied by fire-proof cables that maintain their function. With up to 96 circuits, a maximum of 1920 lights can be supplied and monitored by the multiControl plus. To meet individual requirements, central battery systems offer the option of connecting substations and sub-distributors. By connecting a maximum of 32 substations, the possible number of luminaires that can be monitored increases to over 63,000. A large selection of different housing variants - from the wall cabinet to the free-standing cabinet - can meet many spatial needs.



## CoreCompact 24

4 mains circuits, max. 80 luminaires

The Core Compact 24 emergency lighting system is a state-of-the-art 24-volt low-power system that is extremely easy to install, operate and maintain, offering operational safety and cost-effectiveness at the same time.



## microControl *plus*

max. 6 mains circuits, 500 W / 1h, max. 120 luminaires

The microControl *plus* is a decentralized power supply system with limited output (low power system) up to a maximum of 500 W and service-friendly modular plug-in technology.



## miniControl *plus*

max. 12 mains circuits, 1500 W / 1h, max. 240 luminaires

The dimensions of the miniControl *plus* lie between the smaller microControl plus (500 W / 1h, max. 6 circuits) and the larger miniControl XL plus (1500 W / 1h, max. 32 circuits).



## miniControl XL *plus*

max. 32 mains circuits, 1500 W / 1h, max. 640 luminaires

The miniControl XL *plus* is the largest low power system with a maximum of 32 circuits and a maximum output of 1500 W / 1h.



## midiControl *plus*

max. 32 mains circuits, 5700 W / 1h, max. 640 luminaires

The midiControl *plus* is a preconfigured central battery system with a maximum output of 5700 W / 1h.

As an entry-level model in central battery systems, the midiControl *plus* with its compact motherboard for up to 16 circuit modules and up to 2 charging units offers an optimal price / performance ratio.



## multiControl *plus*

max. 96 main circuits, max. 1920 luminaires

The multiControl *plus* is a central power supply system that convinces with a high degree of flexibility for individual requirements.

A large selection of different housing variants - from the wall cabinet to the free-standing cabinet - can meet many spatial needs. System expansions, which can be found in the options table, can be used to achieve an extensive increase in the range of functions.

LOW POWER SYSTEMS

CENTRAL BATTERY SYSTEMS

SUBSTATIONS AND  
SUBDISTRIBUTIONS

ACCESSORIES AND MODULES

BATTERIES AND  
BATTERY MONITORING

## » SOPHISTICATED TO THE DETAIL



The connection panel is located on the inside of the cabinet on a mounting plate and is used to connect the system to the power supply, to external signaling and operating elements, and to connect to the consumer circuits. As shown in the figure, the electronics compartment offers enough space for wiring the connecting cables.

Depending on the housing, the cable entries are possible from above or optionally from below. Ventilation openings ensure the necessary air circulation in the electronics and battery compartment.

The central power supply system is available in two separate housings (electronics and battery housings) as a wall or floor cabinet. There is also the option of using a combination housing (see figure), which combines the electronic components and the battery in one housing, but separates them from one another by means of an internal partition.



The painting is carried out as standard using textured paint in the color RAL 7035. In order to achieve optimum service convenience, the electronic components are designed in modular slide-in technology, mounted in the cabinet door, which can optionally be equipped with a transparent door.

As shown, the battery can be placed in the sealed battery compartment of the combination housing or in separate housings or battery racks.





# » CENTRAL BATTERY SYSTEMS



## MDC

Central battery system

The MDC system is a central battery system with no power limitation. Depending on the housing design of the MDC, there is space for up to 72 circuits of 10 A each, a charging unit of up to 17.5 A and a permanent and standby light switch, in a standing housing.

Single luminaire or circuit monitoring is not possible with this system. The switchability of the circuits is only possible in connection with the associated contactor changeover.



# THE SYSTEMS COMPARED

	Core Compact 24	microControl plus	miniControl plus	miniControl XL plus	midiControl plus	multiControl plus	MDC
Cabinet	250 x 455 x 230mm	660 x 350 x 230mm	1100 x 500 x 230mm	1470 x 570 x 230mm	1950 x 600 x 450 mm	several	several
max. mains circuits	4	6 (+1)	12 (+1)	32	32	96	72
max. current per circuits	3,6A	3A	3A	4A	4A	6A	6A
possible mains circuit modules	-	DCM 12-E/32	DCM 12-E/32	DCM 12-E/32/42	DCM 12-E/42	DCM 12-E/32/42/62	-
LPS / CBS	LPS	LPS	LPS	LPS	CPS	CPS	CPS
Connection of 230 V luminaires							
max.connected load AC (Total)	440 VA	1682 VA	1682 VA	2810 VA	7340VA	47777 VA $\eta=0,9$	47777 VA $\eta=0,9$
max.supply power (Total)	255 W / 1h 85 W / 3h 25 W / 3h	500 W / 1h 200 W / 3h 80 W / 8h	1500 W / 1h 500 W / 3h 300 W / 8h	1500 W / 1h 500 W / 3h 300W / 8h	5700 W / 1h 2604 W / 3h 1264 W / 8h	43200 W	43200 W
Automatic test facility according to DIN EN 62034							
Single luminaire switching and monitoring without additional wires							
Programmable mains circuits							
Networking of several systems							
Control and monitoring by Web-Interface							
Floor plans in Web-Interface							
Substations / Subdistributions possible							

## » THE CPU

The NLSR emergency lighting control computer forms the central display and test facility for the systems. Via the LCD and web interface, it visualizes the system parameters / states and enables the system to be configured.

- Service-friendly modular slide-in technology
- SD card slot
- Ethernet port
- integrated web interface
- 2x USB port 2.0
- multilingual message texts



The software of the NLSR is continuously developed. With the integrated interfaces (SD card slot, USB ports), it is possible to load new firmware without any special programming knowledge.



The Ethernet interface integrated in the control unit enables the system to be completely configured and monitored via a web interface.

The system can be checked by the manufacturer in the event of service. For this it is necessary to integrate the system into an existing network with an internet connection.



The integrated USB ports offer the option of a standard USB keyboard for configuration of the system via LCD, connection of an external printer (PCL6) and firmware update using a USB stick.

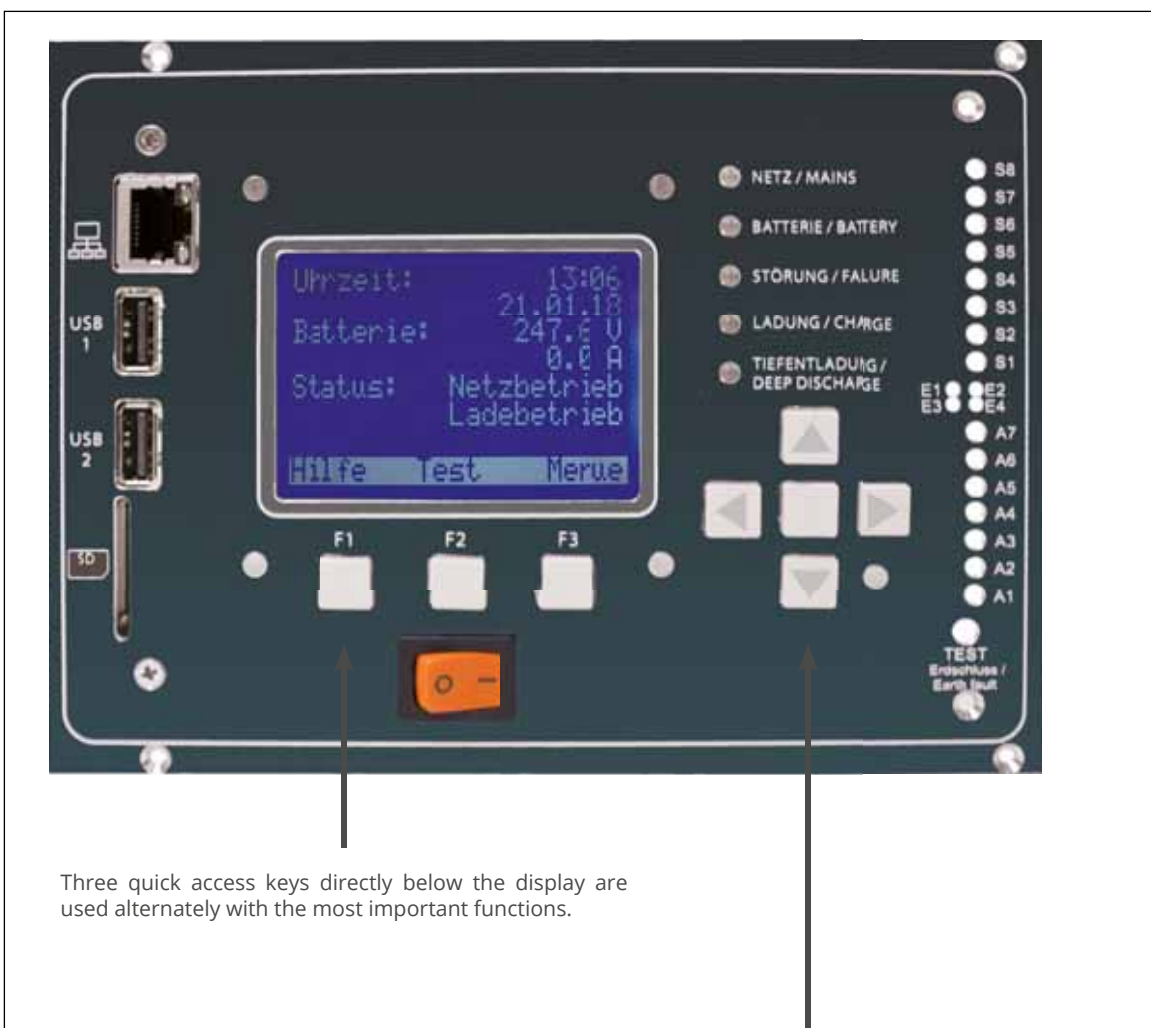

Three quick access keys directly below the display are used alternately with the most important functions.

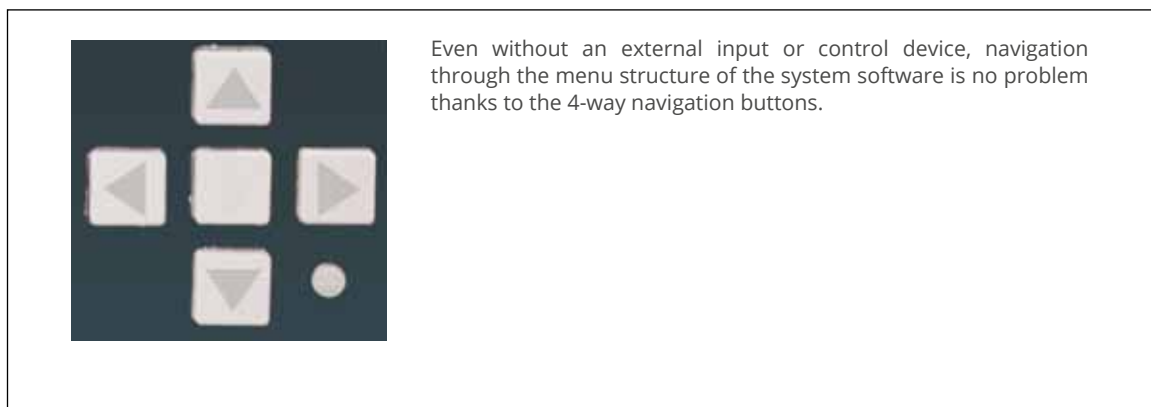

Even without an external input or control device, navigation through the menu structure of the system software is no problem thanks to the 4-way navigation buttons.

# » THE WEB-INTERFACE



The innovative Web-Interface of the multiControl plus series enables information on the system status to be queried with the well-known Internet browsers.

The selectable system status shows information on the current system status, contact details, the result of the last function test and an overview of the circuits.



Individually stored building floor plans make it easier to find faulty lights.

Each installed luminaire can be placed using „drag & drop“ and displayed graphically with type and operating mode.

The plans for the building can be saved as a file directly in the NLSR or, in the case of larger data volumes, on a connected NAS drive.

# » SINGLE LUMINAIRE SWITCHING

When using the DCM12E circuit module, it is possible to switch our luminaires individually and without additional cables in the circuit.

The DCM12E circuit module is designed for use in systems of the multiControl *plus* series (except myControl plus).

The circuit parameters (number of luminaires, operating mode and switching commands) are configured via the Web-Interface.



## 24V LOW POWER SYSTEM

### CORE COMPACT 24 – LOW POWER SYSTEM

The Core Compact 24 emergency lighting system is a state-of-the-art 24-volt low-power system that is extremely easy to install, operate and maintain, offering operational safety and cost-effectiveness at the same time.

The system can be installed and maintained from any end device via an intuitive web interface that, thanks to its modern, responsive design, automatically adapts to the respective screen size. The graphical user interface guarantees increased ease of use and thus short training times for the installer and the Employees of the building operator. A central software update for all system components, including the connected lights, can be carried out from the control center in just a few simple steps via the integrated USB interface. This reduces the effort for data backups and firmware updates to a minimum.

All lights are centrally programmable and dimmable. Schedules can also be programmed, for example to control function tests, scenes and to define building quiet times. These features ensure flexible adaptation to demanding application requirements.

An intelligent setup wizard makes the most important settings at the push of a button, automatically assigns all lights to the correct operating mode as permanent light or stand-by light, and thus shortens the commissioning time, which saves costs and effort.

Thanks to our tried-and-tested monitoring technology, which detects line breaks and short-circuits alike, expensive E30 material can be dispensed with when designing the network monitor loop. Messages on the system status of the system are displayed both on the integrated touch display and on the web interface that can be operated externally. Automatic e-mail notifications when errors occur increase operational reliability. In addition, the system can easily communicate its status to an existing building management system using freely programmable relay contacts.

The system automatically keeps a log book that helps the in-house technician save time during service and maintenance. This means that hardly any additional documentation is required for regular checks. The protective extra-low voltage of maximum 24 volts on the output side guarantees safe working on the system and the connected lights at all times.

When delivered, the system is equipped with a lithium iron phosphate battery. Compared to conventional lead-acid batteries, this type of battery offers a high level of intrinsic safety and a significantly longer service life.





## FACTS

<b>Version:</b>	Wall mounting
<b>Housing:</b>	Steel sheet
<b>Dimensions:</b>	250 x 455 x 230mm
<b>Protection category:</b>	IP20
<b>Insulation class:</b>	I (Input) / III (Output)
<b>Mains connection:</b>	230V AC
<b>Battery:</b>	LiFePO <sub>4</sub> , 20 Ah
<b>permissible ambient Temperature:</b>	10° to 35°C
<b>max. connecting load (AC):</b>	440A
<b>max. supply power (AC):</b>	255 W / 1h 85 W / 3h 25 W / 3h

## FEATURES AT A GLANCE:

- Power supply system according to DIN EN 50171 for Safety lighting systems according to DIN EN 50172 and systems according to DIN VDE 0100-718
- Automatic testing device according to DIN EN 62034
- Combined switching type for non-maintained, maintained and switched maintained luminaires
- Electronic test log for recording all data about a Period > 5 years
- Multilingual menu navigation in German and English
- Management, control and monitoring of up to 20 lights per circuit
- 4 circuits, each with a maximum of 86 VA
- maximum connected load (AC operation) of 440 VA
- Status information of the system in the front touch display
- Web interface for visualization and configuration
- 4x message output (potential-free changeover contact, max. 400V AC/125V DC, 6A, 1500VA), programmable
- 4x galvanically isolated switching input (6-350V AC/DC), reverse polarity tolerant, programmable
- 1x integrated Critical Circuit Interface Module (CCIF) for potential-free mains monitor loop with monitoring Interruption and short circuit of the line

Version	Order number	Battery power	Mains circuits	max. luminaires
Core Compact 24 Compact system	CC24-20	20 Ah	4	80

## LOW POWER SYSTEM



### MICROCONTROL *PLUS* – DECENTRALIZED POWER SUPPLY SYSTEM WITH LIMITED OUTPUT

The microControl plus is a decentralized power supply system with limited output (low power system) up to a maximum of 500 W and service-friendly modular plug-in technology.

This system can be equipped with up to 6 circuits, each of which switches independently and is fused bipolar.

Various switching states can be implemented with the circuits via switch query modules or network monitors. A SAM with 8 inputs is integrated, 15 additional BUS modules can be connected to the system via the BUS interface.

An IO module for forwarding the system status to an external display unit or a building management system via potential-free contacts is integrated in the microControl plus. The microControl plus also has four freely programmable voltage inputs. The connection to the building management system via Modbus or BACnet is possible via another interface.

A CCIF is integrated to monitor a potential-free network monitor loop for interruption and / or termination.

A supply and monitoring of a 24V DC fan is available for the ventilation of optional E30 fire protection distributor housings.

Switched mode enables the connection of our luminaires listed in the catalog, as well as commercially available luminaires, which are designed for supply by an AC and DC voltage.

## FACTS

<b>Version:</b>	Wall housing
<b>Cabinet:</b>	Steel sheet RAL 7035
<b>Dimensions (HxWxD):</b>	660 x 350 x 230mm
<b>Dimensions „E30“ (HxWxD):</b>	918 x 711 x 365mm
<b>Protection category:</b>	IP20 („E30“: IP50)
<b>Insulation class:</b>	I
<b>Mains connection:</b>	230 V AC (±10% ) 50/60Hz
<b>Switched mode:</b>	230 V AC / 216 V DC ±15%
<b>Battery:</b>	216 V DC 18x 12 V / 5,2 Ah
<b>Permissible temp.:</b>	10° to 35° C
<b>max. connected load AC:</b>	1682 VA
<b>max. connected load DC:</b>	500 W / 1h 200 W / 3h 80 W / 8h

## FEATURES AT A GLANCE:

- Power supply system according to DIN EN 50171 for safety lighting systems according to DIN EN 50172 and systems according to DIN VDE 0100-718
- automatic test facility according to DIN EN 62034
- Combined switching type for maintained, non-maintained and switched maintained light
- Service-friendly modular 19 "slide-in technology
- Electronic test book for recording all data over a period of > 5 years
- multilingual menu navigation, e.g. German English
- Management and error display of up to 20 lights each circuit
- 6 circuits of max. 650 VA
- 1 auxiliary circuit max. 150 VA
- Maximum connected load (AC operation) of 1682 VA
- Status information of the system in plain text as well as status LEDs
- Interface for external modules SAM24, MC-LM, MCT15 via RS485BUS
- up to 6 switching inputs per circuit
- Networking of systems possible via Ethernet (TCP / IP)
- Web interface for visualization and configuration

### integrated light switch query module SAM:

- 8x switching input on terminal (200 - 255 V AC or 24 - 255 V DC) for switching the circuits in AC operation
- 3 circuit types (sw. maintained, maintained, non-maintained) programmable

### integrated IO module:

- 7x relay output, 230 V AC, 6 A / 30 V DC, 6A, floating changeover contact
- 4x galvanically isolated switching input (200 - 255 V AC or 24 - 255 V DC), reverse polarity-tolerant, function programmable

### integrated CCIF - Critical Circuit Interface Module

- Monitoring of a potential-free network monitor loop for interruption and termination of the line



Version	Order number	Mains circuits	max. Luminaires
microControl <i>plus</i> 102	MI102	2	40
microControl <i>plus</i> 104	MI104	4	80
microControl <i>plus</i> 106	MI106	6	120

## LOW POWER SYSTEM

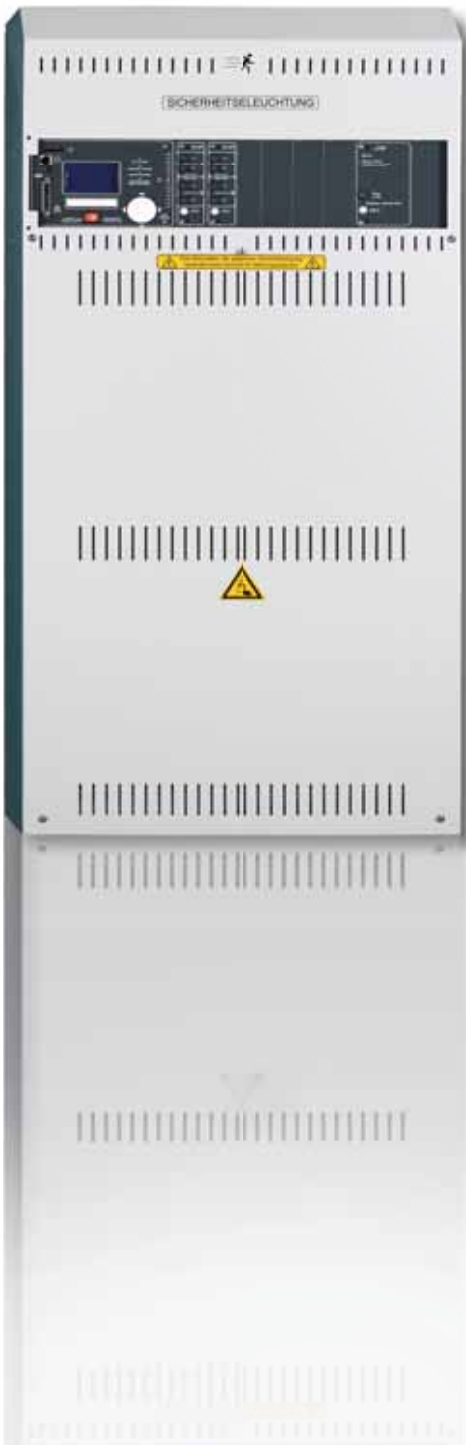

### MINICONTROL *PLUS* – DECENTRALIZED POWER SUPPLY SYSTEM WITH LIMITED OUTPUT

The miniControl plus is a decentralized power supply system with limited output (low power system) up to a maximum of 1500 W and service-friendly modular plug-in technology.

This system can be equipped with up to 12 circuits, each switching independently and being fused bipolar.

Various switching states can be implemented with the circuits via switch query modules or network monitors. A SAM with 8 inputs is integrated, 15 additional BUS modules can be connected to the system via the BUS interface.

An IO module for forwarding the system status to an external display unit or a building management system via potential-free contacts is integrated in the miniControl plus. The miniControl plus also has four freely programmable voltage inputs. The connection to the building management system via Modbus or BACnet is possible via another interface.

A CCIF is integrated to monitor a potential-free network monitor loop for interruption and / or termination.

A supply and monitoring of a 24V DC fan is available for the ventilation of optional E30 fire protection distributor housings.

Switched mode enables the connection of our luminaires listed in the catalog, as well as commercially available luminaires, which are designed for supply by an AC and DC voltage.

## FACTS

<b>Version:</b>	Wall housing
<b>Cabinet:</b>	Steel sheet RAL 7035
<b>Dimensions (HxWxD):</b>	1100 x 500 x 230mm
<b>Dimensions „E30“ (HxWxD):</b>	1388 x 861 x 365mm
<b>Protection category:</b>	IP20 („E30“: IP50)
<b>Insulation class:</b>	I
<b>Mains connection:</b>	230 V AC (±10% ) 50/60Hz
<b>Switched mode:</b>	230 V AC / 216 V DC ±15%
<b>Battery:</b>	216 V DC
	18x 12 V / 17 Ah
<b>Permissible temp.:</b>	10° to 35° C
<b>max. connected load AC:</b>	1682 VA
<b>max. connected load DC:</b>	1500 W / 1h 500 W / 3h 300 W / 8h

## FEATURES AT A GLANCE:

- Power supply system according to DIN EN 50171 for safety lighting systems according to DIN EN 50172 and systems according to DIN VDE 0100-718
- automatic test facility according to DIN EN 62034
- Combined switching type for maintained, non-maintained and switched maintained light
- Service-friendly modular 19 "slide-in technology
- Electronic test book for recording all data over a period of > 5 years
- multilingual menu navigation, e.g. German English
- Management and error display of up to 20 lights each circuit
- 12 circuits of max. 650 VA
- 1 auxiliary circuit max. 150 VA
- Maximum connected load (AC operation) of 1682 VA
- Status information of the system in plain text as well as status LEDs
- Interface for external modules SAM24, MC-LM, MCT15 via RS485BUS
- up to 6 switching inputs per circuit
- Networking of systems possible via Ethernet (TCP / IP)
- Web interface for visualization and configuration

### integrated light switch query module SAM:

- 8x switching input on terminal (200 - 255 V AC or 24 - 255 V DC) for switching the circuits in AC operation
- 3 circuit types (sw. maintained, maintained, non-maintained) programmable

### integrated IO module:

- 7x relay output, 230 V AC, 6 A / 30 V DC, 6A, floating changeover contact
- 4x galvanically isolated switching input (200 - 255 V AC or 24 - 255 V DC), reverse polarity-tolerant, function programmable

### integrated CCIF - Critical Circuit Interface Module

- Monitoring of a potential-free network monitor loop for interruption and termination of the line



Version	Order number	Mains circuits	max. Luminaires
miniControl plus 102	MN102	2	40
miniControl plus 104	MN104	4	80
miniControl plus 106	MN106	6	120
miniControl plus 108	MN108	8	160
miniControl plus 110	MN110	10	200
miniControl plus 112	MN112	12	240

# » miniControl XL *plus*

## LOW POWER SYSTEM

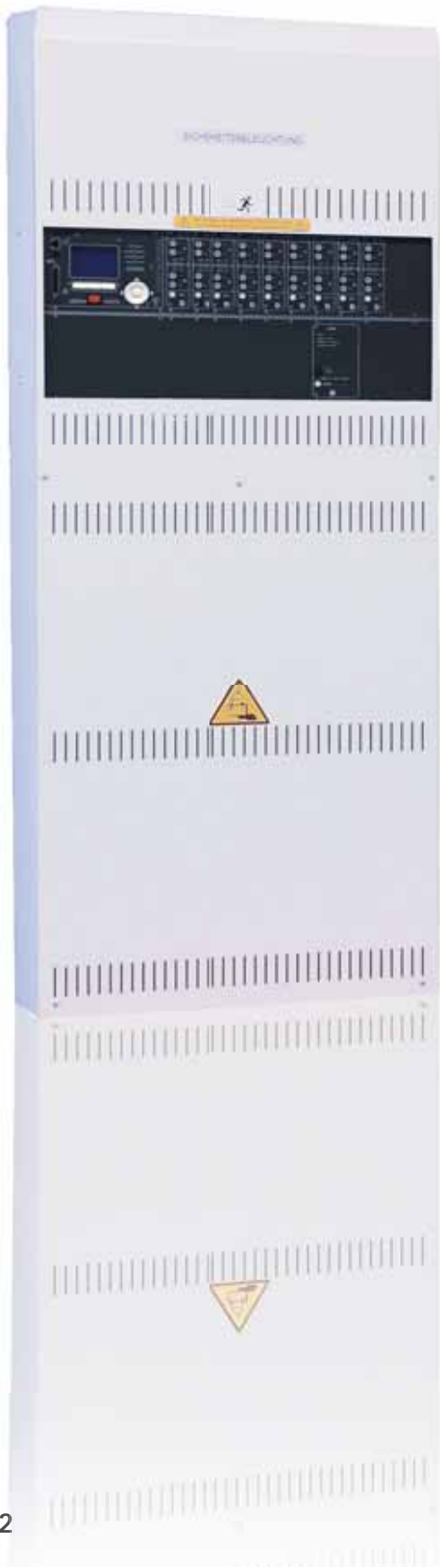

### MINICONTROL XL PLUS – DECENTRALIZED POWER SUPPLY SYSTEM WITH LIMITED OUTPUT

The miniControl XL plus is a decentralized power supply system with limited output (low power system) up to a maximum of 1500 W and service-friendly modular plug-in technology.

This system can be equipped with up to 32 circuits, each of which switches independently and is fused bipolar.

Various switching states can be implemented with the circuits via switch query modules or network monitors. A SAM with 8 inputs is integrated, 15 additional BUS modules can be connected to the system via the BUS interface.

An IO module for forwarding the system status to an external display unit or a building management system via potential-free contacts is integrated in the miniControl XL plus. The miniControl XL plus also has four freely programmable voltage inputs. The connection to the building management system via Modbus or BACnet is possible via another interface.

A CCIF is integrated to monitor a potential-free network monitor loop for interruption and / or termination.

A supply and monitoring of a 24V DC fan is available for the ventilation of optional E30 fire protection distributor housings.

Switched mode enables the connection of our luminaires listed in the catalog, as well as commercially available luminaires, which are designed for supply by an AC and DC voltage.

**Also available with BAT-LOGG®:  
Making batteries smart!**

## FACTS

<b>Version:</b>	Wall housing
<b>Cabinet:</b>	Steelsheet RAL 7035
<b>Dimensions (HxWxD):</b>	1472,5 x 570 x 230mm
<b>Dimensions „E30“ (HxWxD):</b>	1828 x 908 x 395mm
<b>Protection category:</b>	IP20 („E30“: IP50)
<b>Insulation class:</b>	I
<b>Mains connection:</b>	230 V AC (±10% ) 50/60Hz
<b>Switched mode:</b>	230 V AC / 216 V DC ±15%
<b>Battery:</b>	216 V DC 18x 12 V / 17 Ah
<b>Permissible temp.:</b>	10° to 35° C
<b>max. connected load AC:</b>	2810 VA
<b>max. connected load DC:</b>	1500 W / 1h 500 W / 3h 300 W / 8h

## FEATURES AT A GLANCE:

- Power supply system according to DIN EN 50171 for safety lighting systems according to DIN EN 50172 and systems according to DIN VDE 0100-718
- automatic test facility according to DIN EN 62034
- Combined switching type for standby, steady light and switched steady light
- Service-friendly modular 19 "slide-in technology
- Electronic test book for recording all data over a period of > 5 years
- multilingual menu navigation, e.g. German English
- Management and error display of up to 20 lights each circuit
- 32 circuits of max. 860 VA
- Maximum connected load (AC operation) of 2810 VA
- Status information of the system in plain text as well as status LEDs
- Interface for external modules SAM24, MC-LM, MCT15 via RS485BUS
- up to 6 switching inputs per circuit
- Networking of systems possible via Ethernet (TCP / IP)
- Web interface for visualization and configuration

### integrated light switch query module SAM:

- 8x switching input on terminal (200 - 255 V AC or 24 - 255 V DC) for switching the circuits in AC operation
- 3 circuit types (sw. maintained, maintained, non-maintained) programmable

### integrated IO module:

- 7x relay output, 230 V AC, 6 A / 30 V DC, 6A, floating changeover contact
- 4x galvanically isolated switching input (200 - 255 V AC or 24 - 255 V DC), reverse polarity-tolerant, function programmable

### integrated CCIF - Critical Circuit Interface Module

- Monitoring of a potential-free network monitor loop for interruption and termination of the line

Version	Order number	Mains circuits	max. Luminaires
miniControl XL <i>plus</i> 102	MNXL102	2	40
miniControl XL <i>plus</i> 104	MNXL104	4	80
miniControl XL <i>plus</i> 106	MNXL106	6	120
miniControl XL <i>plus</i> 108	MNXL108	8	160
...	...	...	...
miniControl XL <i>plus</i> 132	MNXL132	32	640

## CENTRAL BATTERY SYSTEM



### MIDICONTROL *PLUS* – CENTRAL BATTERY SYSTEM

The midiControl plus is a central battery system up to a maximum of 5700 W and service-friendly modular slide-in technology.

This system can be equipped with up to 32 circuits, each of which switches independently and is fused bipolar.

Various switching states can be implemented with the circuits via switch query modules or network monitors. A SAM with 8 inputs is integrated, 15 additional BUS modules can be connected to the system via the BUS interface.

An IO module for forwarding the system status to an external display unit or a building management system via floating contacts is integrated in the midiControl plus. The midiControl plus also has four freely programmable voltage inputs. The connection to the building management system via Modbus or BACnet is possible via another interface.

A CCIF is integrated to monitor a potential-free network monitor loop for interruption and / or termination.

Switched mode enables the connection of our luminaires listed in the catalog, as well as commercially available luminaires, which are designed for supply by an AC and DC voltage.

With up to two 2.5A chargers and battery housings up to a maximum battery size of 55 Ah, an output of 5700W is possible for one hour.

**Also available with BAT-LOGG®:  
Making batteries smart!**



## FACTS

<b>Version:</b>	Tower housing
<b>Cabinet:</b>	Steel sheet RAL 7035
<b>Dimensions (HxWxD):</b>	1950 x 600 x 450mm
<b>Protection category:</b>	IP20
<b>Insulation class:</b>	I
<b>Mains connection:</b>	3x 230 V AC (±10%) 50/60Hz
<b>Switched mode:</b>	230 V AC / 216 V DC ±15%
<b>Battery:</b>	216 V DC max. 18x 12 V / 55 Ah
<b>Permissible temp.:</b>	10° to 35° C
<b>max. connected load AC:</b>	7340 VA
<b>max. connected load DC*:</b>	5700 W / 1h 2604 W / 3h 1264 W / 8h

\* Battery-dependent, the values given correspond to 55 Ah

## FEATURES AT A GLANCE:

- Central power supply system according to DIN EN 50171 for safety lighting systems according to DIN EN 50172 and systems according to DIN VDE 0100-718
- automatic test facility according to DIN EN 62034
- Combined switching type for maintained, non-maintained and switched maintained light
- Service-friendly modular 19 "slide-in technology
- Electronic test book for recording all data over a period of > 5 years
- multilingual menu navigation, e.g. German English
- Management and error display of up to 20 lights each circuit
- 32 circuits of max. 860 VA
- Maximum connected load (AC operation) of 7340 VA
- Status information of the system in plain text as well as status LEDs
- Interface for external modules SAM24, MC-LM, MCT15 via RS485BUS
- up to 6 switching inputs per circuit
- Networking of systems possible via Ethernet (TCP / IP)
- Web interface for visualization and configuration

### Integrated light switch query module SAM:

- 8x switching input on terminal (200 - 255 V AC or 24 - 255 V DC) for switching the circuits in AC operation
- 3 circuit types (sw. maintained, maintained, non-maintained) programmable

### Integrated IO module:

- 7x relay output, 230 V AC, 6 A / 30 V DC, 6A, floating changeover contact
- 4x galvanically isolated switching input (200 - 255 V AC or 24 - 255 V DC), reverse polarity-tolerant, function programmable

### Integrated CCIF - Critical Circuit Interface Module

- Monitoring of a potential-free network monitor loop for interruption and termination of the line

Version	Order number	Charger	Mains circuits	max. Luminaires
midicontrol <i>plus</i> 102	MD102	1	2	40
midicontrol <i>plus</i> 104	MD104	1	4	80
...	...	...	...	...
midicontrol <i>plus</i> 132	MD132	1	32	640
midicontrol <i>plus</i> 202	MD202	2	2	40
midicontrol <i>plus</i> 204	MD204	2	4	80
...	...	...	...	...
midicontrol <i>plus</i> 232	MD232	2	32	640

## CENTRAL BATTERY SYSTEM



### MULTICONTROL *PLUS* – CENTRAL BATTERY SYSTEM

The multiControl plus is a central battery system up to a maximum of 43200 W and service-friendly modular slide-in technology.

This system can be equipped with up to 96 circuits, each of which switches independently and is fused bipolar.

Various switching states can be implemented with the circuits via switch query modules or network monitors. Up to 16 BUS modules can be connected to the system via the BUS interface.

An IO module for forwarding the system status to an external display unit or a building management system via potential-free contacts is integrated in the multiControl plus. The multiControl plus also has two programmable voltage inputs connected to the terminal. The connection to the building management system via Modbus or BACnet is possible via another interface.

The monitoring of a potential-free network monitor loop for interruption is integrated. The monitoring of the network monitor loop for clumping / closing is optionally possible.

Switched mode enables the connection of our luminaires listed in the catalog, as well as commercially available luminaires, which are designed for supply by an AC and DC voltage.

With up to ten 2.5A chargers as standard and battery sets connected in parallel, a maximum output of 43200W is possible for one hour.

Up to 32 systems or substations can be connected to the multiControl plus and monitored.

By using sub-distributors of type MCVU and MCVU-E, circuits of the multiControl plus can be outsourced based on the fire compartment, thereby reducing the fire load and the installation material.

**Also available with BAT-LOGG®:  
Making batteries smart!**

## FACTS

<b>Version:</b>	Tower- / Surface or wall housing
<b>Cabinet:</b>	Steelsheet RAL 7035
<b>Dimensions:</b>	see systems list
<b>Protection category:</b>	IP20 (optional IP21, IP54, E30)
<b>Insulation class:</b>	I
<b>Mains connection:</b>	3 x 230V AC (± 10%) 50/60Hz
<b>Switched mode:</b>	230 V AC / 216 V DC ±15%
<b>Battery:</b>	216 V DC, Up to three strings of 18 x 12V lead acid batteries
<b>permissible Temp.:</b>	10°C to 35°C
<b>Cable feed:</b>	from Top (from below on request)



## FEATURES AT A GLANCE:

- Central power supply system according to DIN EN 50171 for safety lighting systems according to DIN EN 50172 and systems according to DIN VDE 0100-718
- automatic test facility according to DIN EN 62034
- Combined switching type for maintained, non-maintained and switched maintained light
- Service-friendly modular 19 "slide-in technology
- Electronic test book for recording all data over a period of > 5 years
- multilingual menu navigation, e.g. German English
- Management and error display of up to 20 lights each circuit
- 96 circuits of max. 1300 VA
- Maximum connected load (AC operation) of 47777 VA
- Status information of the system in plain text as well as status LEDs
- Interface for external modules SAM24, MC-LM, MCT15 via RS485BUS
- up to 6 switching inputs per circuit
- Networking of systems possible via Ethernet (TCP / IP)
- Web interface for visualization and configuration

### Optional light switch query module SAM:

- 8x switching input on terminal (200 - 255 V AC or 24 - 255 V DC) for switching the circuits in AC operation
- 3 circuit types (sw. maintained, maintained, non-maintained) programmable

### Integrated IO module:





- 7x relay output, 230 V AC, 6 A / 30 V DC, 6A, floating changeover contact
- 4x galvanically isolated switching input (200 - 255 V AC or 24 - 255 V DC), reverse polarity-tolerant, function programmable

### Integrated monitoring of a mains monitor loop

- Monitoring of a potential-free mains monitor loop for interruption and termination of the line

## CENTRAL BATTERY SYSTEM

Auszug aus der Anlagenliste – weitere Konfigurationen sind möglich

	Version	Order number	Charger	Cabinet HxWxD	max. circuits	max. DCM
	<b>Combi device incl. central unit and battery compartment up to 17Ah, AC-Feeding 1x, 2x or 3x 230V, 50/60Hz</b>					
	multiControl <i>plus</i> 12/2,5A Combi 1000	MCK112	2,5A	1000 x 600 x 400	12	6
	multiControl <i>plus</i> 24/2,5A Combi 1000	MCK124	2,5A	1000 x 600 x 400	24	12
	multiControl <i>plus</i> 36/2,5A Combi 1000	MCK136	2,5A	1000 x 600 x 400	36	18
	<b>Combi device incl. central unit and battery compartment up to 45Ah, AC-Feeding 1x, 2x or 3x 230V, 50/60Hz</b>					
	multiControl <i>plus</i> 12/2,5A Combi 1500	MCG112	2,5A	1500 x 600 x 450	12	6
	multiControl <i>plus</i> 24/2,5A Combi 1500	MCG124	2,5A	1500 x 600 x 450	24	12
	multiControl <i>plus</i> 36/2,5A Combi 1500	MCG136	2,5A	1500 x 600 x 450	36	18
	<b>Surface- / Wall housing, without battery compartment, incl. charger AC-Feeding 1x, 2x or 3x 230V, 50/60Hz</b>					
	multiControl <i>plus</i> 900 12/2,5A	MCW112	2,5A	900 x 600 x 450	12	6
	multiControl <i>plus</i> 900 24/2,5A	MCW124	2,5A	900 x 600 x 450	24	12
	multiControl <i>plus</i> 900 36/5,0A	MCW236	5,0A	900 x 600 x 450	36	18
	multiControl <i>plus</i> 900 36/7,5A	MCW336	7,5A	900 x 600 x 450	36	18
	multiControl <i>plus</i> 900 48/7,5A	MCW348	7,5A	900 x 600 x 450	48	24
	<b>Tower Housing incl. central unit, without battery compartment, incl. charger, AC-Feeding 1x, 2x or 3x 230V, 50/60Hz</b>					
	multiControl <i>plus</i> 1800 12/7,5A	MCS312	7,5A	1800 x 600 x 450	12	6
	multiControl <i>plus</i> 1800 12/10,0A	MCS412	10,0A	1800 x 600 x 450	12	6
	multiControl <i>plus</i> 1800 12/12,5A	MCS512	12,5A	1800 x 600 x 450	12	6
	multiControl <i>plus</i> 1800 12/15,0A	MCS612	15,0A	1800 x 600 x 450	12	6
	multiControl <i>plus</i> 1800 12/17,5A	MCS712	17,5A	1800 x 600 x 450	12	6
	multiControl <i>plus</i> 1800 12/20,0A	MCS812	20,0A	1800 x 600 x 450	12	6
	multiControl <i>plus</i> 1800 12/22,5A	MCS912	22,5A	1800 x 600 x 450	12	6
	multiControl <i>plus</i> 1800 12/25,0A	MCS1012	25,0A	1800 x 600 x 450	12	6
	multiControl <i>plus</i> 1800 24/20,0A	MCS824	20,0A	1800 x 600 x 450	24	12
	multiControl <i>plus</i> 1800 24/25,0A	MCS1024	25,0A	1800 x 600 x 450	24	12
	multiControl <i>plus</i> 1800 36/10,0A	MCS436	10,0A	1800 x 600 x 450	36	18
	multiControl <i>plus</i> 1800 36/20,0A	MCS836	20,0A	1800 x 600 x 450	36	18
	multiControl <i>plus</i> 1800 36/25,0A	MCS1036	25,0A	1800 x 600 x 450	36	18
	multiControl <i>plus</i> 1800 48/12,5A	MCS548	12,5A	1800 x 600 x 450	48	24
	multiControl <i>plus</i> 1800 48/25,0A	MCS1048	25,0A	1800 x 600 x 450	48	24
	multiControl <i>plus</i> 1800 60/20,0A	MCS860	20,0A	1800 x 600 x 450	60	30
	multiControl <i>plus</i> 1800 72/15,0A	MCS672	15,0A	1800 x 600 x 450	72	36
multiControl <i>plus</i> 1800 72/25,0A	MCS1072	25,0A	1800 x 600 x 450	72	36	
multiControl <i>plus</i> 1800 96/15,0A	MCS696	15,0A	1800 x 600 x 450	96	48	

Further system configurations on request (e.g. additional loaders, MCABUS, etc.)

\* Attention: When connecting substations / sub-distributors or installing optional modules (SAM24M), please contact our technical department in advance (additional space may be required in the cabinet)!

This can reduce the max. number of possible circuits or the number of charger modules!

## GEHÄUSE



Type	MCW	MCK	MCG	MCS	MCX
Cabinet	Wall housing	Tower-/ Wall housing	Tower housing	Tower housing	Tower housing
Dimensions in mm	900 x 600 x 450	1000 x 600 x 400	1500 x 600 x 450	1800 x 600 x 450	1850 x 800 x 600
Cable feed	from Top (from below on request)				
max. charging current	7,5 A	2,5 A	2,5 A	25 A	10 A
max. mains circuits	48	36	48	96	60
Mains connection	3x 230 V, 50/60 Hz				

# CONNECTION DIAGRAM

## MULTICONTROL

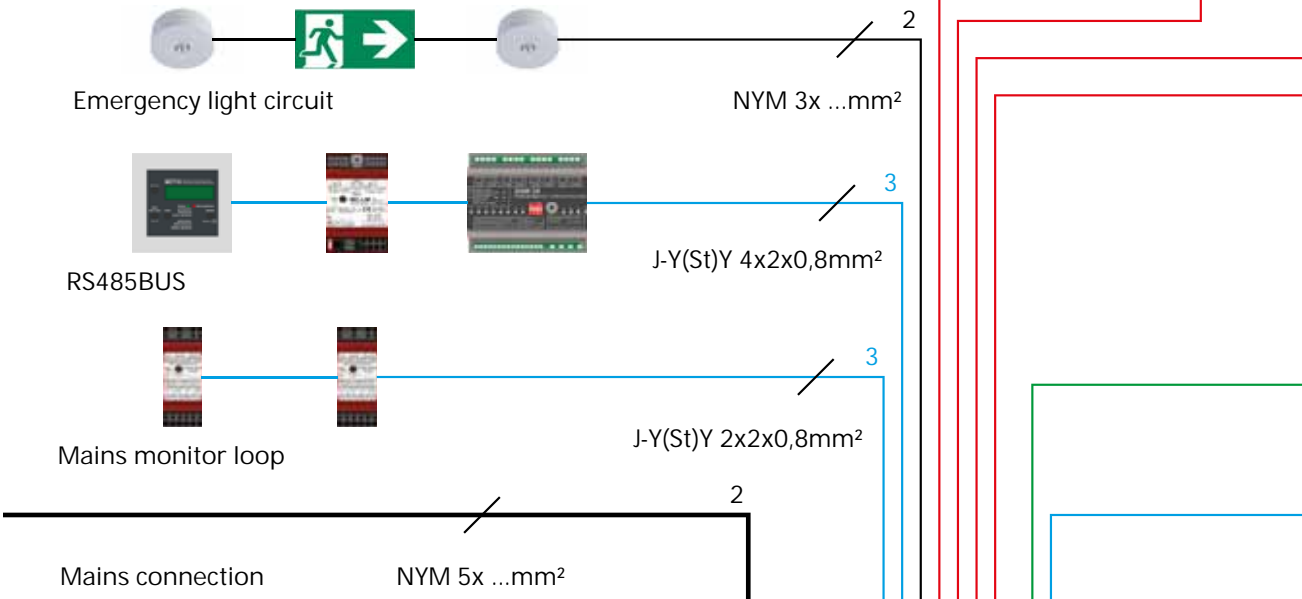
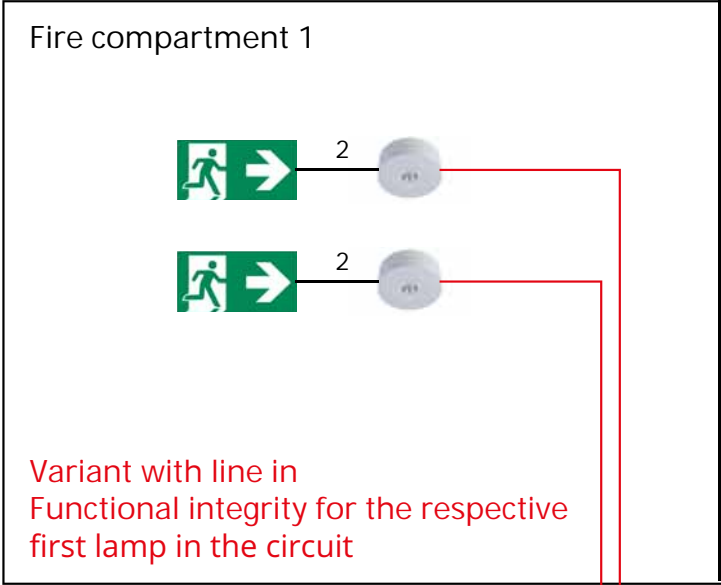

- 1 — Line in functional integrity (N)HXH ... 3x ...
- 2 — Normal mains line NYM...
- 3 — Data cable J-Y(St)Y
- 4 — Network cable Cat.5 / Cat.7



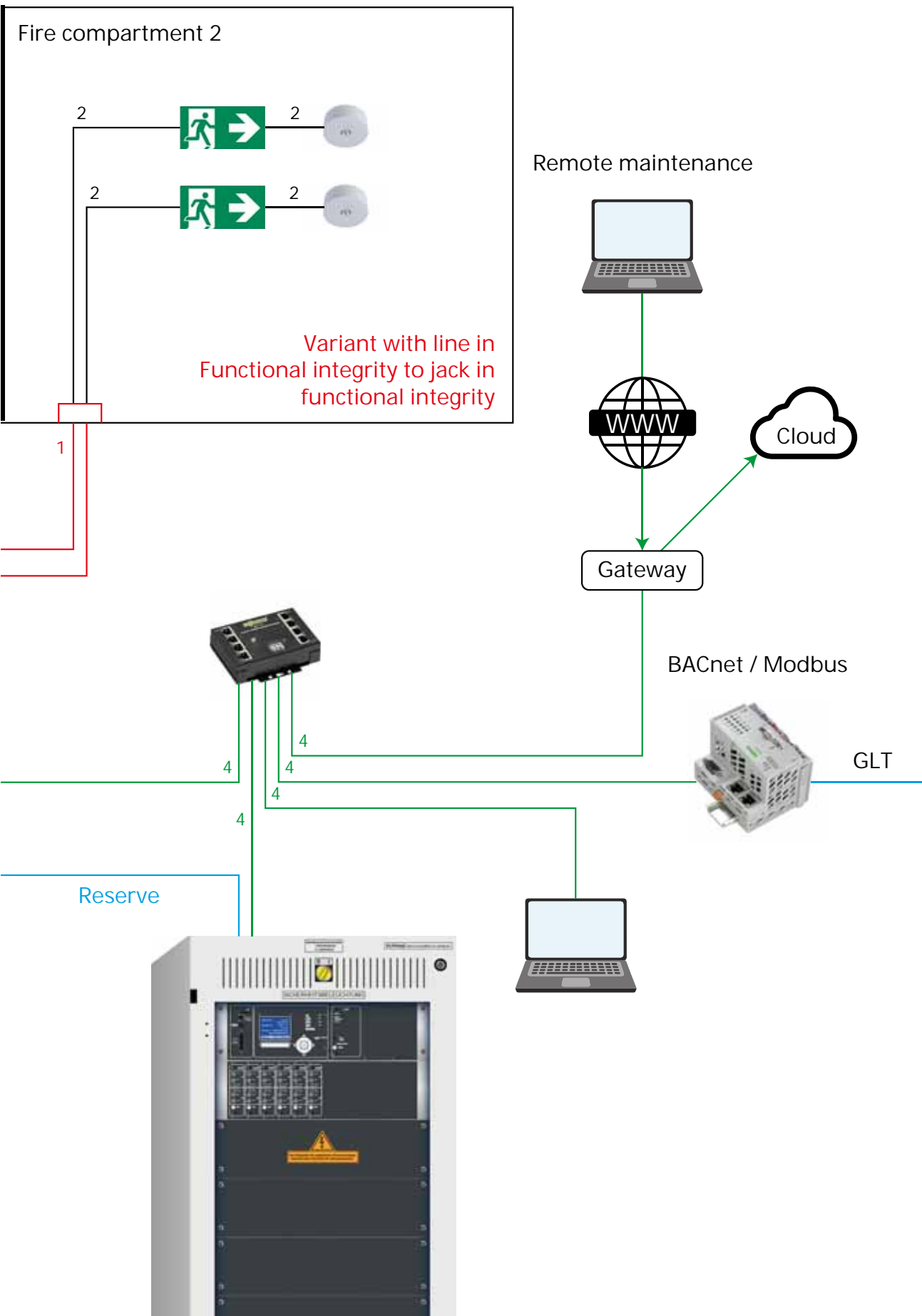

## CENTRAL BATTERY SYSTEM



### MDC – CENTRAL BATTERY SYSTEM

The MDC is a central battery system up to a maximum of 43200 W and service-friendly modular slide-in technology.

This system is equipped with separate two-pole fused circuits. The system is switched via AC / DC contactor switches. The combined operation of continuous and standby lights (mixed operation), individual light monitoring and current monitoring of individual circuits is not possible.

Various switching states can be implemented with the contactor changeovers via switch query modules or network monitors. Up to 16 BUS modules can be connected to the system via the BUS interface.

An IO module for forwarding the system status to an external display unit or a building management system via potential-free contacts is integrated in the MDC. The MDC also has two programmable voltage inputs connected to the terminal. The connection to the building management system via Modbus or BACnet is possible via another interface.

The monitoring of a potential-free network monitor loop for interruption is integrated. The monitoring of the network monitor loop for clumping / closing is optionally possible, depending on the requirements for the overall system or selectively for each contactor changeover.

Switched mode enables the connection of our luminaires listed in the catalog, as well as commercially available luminaires, which are designed for supply by an AC and DC voltage.

With up to ten 2.5A chargers as standard and battery sets connected in parallel, a maximum output of 43200W is possible for one hour.

Up to 32 systems or substations can be connected to the MDC and monitored.

**Also available with BAT-LOGG®:  
Making batteries smart!**



## FACTS

<b>Version:</b>	Tower- / Wall housing
<b>Cabinet:</b>	Steelsheet RAL 7035
<b>Dimensions:</b>	see systems list
<b>Protection category:</b>	IP20 (optional IP21, IP54, E30)
<b>Insulation class:</b>	I
<b>Mains connection:</b>	3 x 230V AC (± 10%) 50/60Hz
<b>Switched mode:</b>	230 V AC / 216 V DC ±15%
<b>Battery:</b>	216 V DC, 18x 12 V maintenance free closed lead acid battery
<b>permissible Temp.:</b>	10°C to 35°C
<b>Cable feed:</b>	from Top (from below on request)

## FEATURES AT A GLANCE:

- Central power supply system according to DIN EN 50171 for safety lighting systems according to DIN EN 50172 and systems according to DIN VDE 0100-718
- Service-friendly modular 19 "slide-in technology
- Electronic test book for recording all data over a period of > 5 years
- multilingual menu navigation, e.g. German English
- Maximum connected load (AC operation) of 47777 VA
- Status information of the system in plain text as well as status LEDs
- Interface for external modules SAM24, MC-LM, MCT15 via RS485BUS
- up to 6 switching inputs per changeover
- Networking of systems possible via Ethernet (TCP / IP)
- Web interface for visualization and configuration

### Optional switch query module SAM24M:

- 8x switch input on terminal (200 - 255 V AC or 24 - 255 V DC) for switching the circuits in AC mode
- 2 circuit types (gDS, MB) programmable

### Integrated IO module:

- 7x relay output (3x on terminal), 230 V AC, 6 A / 30 V DC, 6A, floating changeover contact
- 4x galvanically (2x on terminal) separate switching input (200 - 255 V AC or 24 - 255 V DC), reverse polarity-tolerant, function programmable

### Integrated monitoring of a network monitor loop

- Monitoring of a potential-free network monitor loop for interruption

Version	Order number	Charger	Cabinet
<b>Combi device with central unit and battery compartment 1500mm incl. charger, battery compartment up to 45Ah, AC-Feeding 1x, 2x or 3x 230V, 50/60Hz</b>			
MDC220 / 2,5A Combi 1500 without DBU	MDG1	2,5A	1500 x 600 x 450
<b>Surface- / Wall housing with central unit, without battery compartment incl. charger, AC-Feeding 3x 230V, 50/60Hz</b>			
MDC220 / 2,5A ES900 without DBU	MDW1	2,5A	900 x 600 x 450
MDC220 / 5A ES900 without DBU	MDW2	5,0A	900 x 600 x 450
MDC220 / 7,5A ES900 without DBU	MDW3	7,5A	900 x 600 x 450
<b>Tower housing with central unit, without battery compartment, incl. charger, AC-Feeding 3x 230V, 50/60Hz</b>			
MDC220 / 2,5A ES1800 without DBU	MDS1	2,5A	1800 x 600 x 450
MDC220 / 5A ES1800 without DBU	MDS2	5,0A	1800 x 600 x 450
MDC220 / 7,5A ES1800 without DBU	MDS3	7,5A	1800 x 600 x 450
MDC220 / 10A ES1800 without DBU	MDS4	10,0A	1800 x 600 x 450
MDC220 / 12,5A ES1800 without DBU	MDS5	12,5A	1800 x 600 x 450
MDC220 / 15A ES1800 without DBU	MDS6	15,0A	1800 x 600 x 450
MDC220 / 17,5A ES1800 without DBU	MDS7	17,5A	1800 x 600 x 450
MDC220 / 20A ES1800 without DBU	MDS8	20,0A	1800 x 600 x 450

## SUBSTATIONS

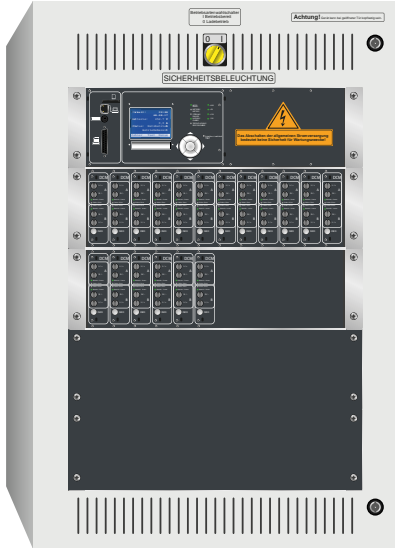

### MULTICONTROL *PLUS* SUBSTATION

The multiControl plus substation is a system for connection to multiControl plus type main systems, whereby it serves to increase the number of circuits of an overall system and / or to reduce installation effort / material without its own battery.

The energy supply (AC / DC voltage) is realized by an outgoing substation in the main system.

This system can be equipped with up to 96 circuits, each of which switches independently and is fused bipolar.

Various switching states can be implemented with the circuits via switch query modules or network monitors. Up to 16 BUS modules can be connected to the system via the BUS interface.

An IO module for forwarding the system status to an external display unit or a building management system via potential-free contacts is integrated in the multiControl plus substation. The multiControl plus substation also has two programmable voltage inputs connected to the terminal. The connection to the building management system via Modbus or BACnet is possible via another interface.

The monitoring of a potential-free network monitor loop for interruption is integrated. The monitoring of the network monitor loop for clumping / closing is optionally possible.

Switched mode enables the connection of our luminaires listed in the catalog, as well as commercially available luminaires, which are designed for supply by an AC and DC voltage.

By using sub-distributors of type MCVU and MCVU-E, circuits of the multiControl plus substation can be outsourced based on the fire section, thereby reducing the fire load and the installation material.



### microControl *plus* SUBSTATION

The compact substation with up to 6 circuits, based on the microControl plus, for connection to main systems of the multiControl plus type.

The range of functions corresponds to that of the microControl plus. The maximum connected load is 1500W.

## FACTS

<b>Version:</b>	Wall housing
<b>Cabinet:</b>	Steelsheet RAL 7035
<b>Dimensions:</b>	see systems list
<b>Protection category:</b>	IP20 (optional IP21, IP54, E30)
<b>Insulation class:</b>	I
<b>Mains connection:</b>	3 x 230V AC (± 10%) 50/60Hz
<b>Switched mode:</b>	230 V AC / 216 V DC ±15%
<b>permissible Temp.:</b>	0°C to 35°C
<b>Cable feed:</b>	from Top (from below on request)

## FEATURES AT A GLANCE:

- Central power supply system according to DIN EN 50171 for safety lighting systems according to DIN EN 50172 and systems according to DIN VDE 0100-718
- automatic test facility according to DIN EN 62034
- Combined switching type for standby, steady light and switched steady light
- Service-friendly modular 19 "slide-in technology
- Electronic test book for recording all data over a period of > 5 years
- multilingual menu navigation, e.g. German English
- Management and error display of up to 20 lights each circuit
- 96 circuits of max. 1300 VA
- Maximum connected load (AC operation) of the entire system consisting of main system, substation (s) and sub-distributor (-n) of 47777 VA
- Status information of the system in plain text as well as status LEDs
- Interface for external modules SAM24, MC-LM, MCT15 via RS485BUS
- up to 6 switching inputs per circuit
- Networking of systems possible via Ethernet (TCP / IP)
- Web interface for visualization and configuration

### Optional light switch query module SAM:

- 8x switching input on terminal (200 - 255 V AC or 24 - 255 V DC) for switching the circuits in AC operation
- 3 circuit types (sw. maintained, maintained, non-maintained) programmable

### Integrated IO module:

- 7x relay output, 230 V AC, 6 A / 30 V DC, 6A, floating changeover contact
- 4x galvanically isolated switching input (200 - 255 V AC or 24 - 255 V DC), reverse polarity-tolerant, function programmable

### Integrated CCIF - Critical Circuit Interface Module

- Monitoring of a potential-free network monitor loop for interruption and termination of the line

Version	Order number	Cabinet	max. Circuits	max. DCM
multiControl <i>plus</i> Substation UCW012	UCW012	550 x 600 x 450mm	12	6
multiControl <i>plus</i> Substation UCW024	UCW024	550 x 600 x 450mm	24	12
multiControl <i>plus</i> Substation UCW036	UCW036	900 x 600 x 450mm	36	18
multiControl <i>plus</i> Substation UCW048	UCW048	900 x 600 x 450mm	48	24
multiControl <i>plus</i> Substation UCW060	UCW060	900 x 600 x 450mm	60	30
multiControl <i>plus</i> Substation UCW072	UCW072	900 x 600 x 450mm	72	36
multiControl <i>plus</i> Substation UCW084	UCW084	900 x 600 x 450mm	84	42
multiControl <i>plus</i> Substation UCW096	UCW096	900 x 600 x 450mm	96	48

## SUBDISTRIBUTOR MCUV



The MCUV is a system for connecting to main systems of the multiControl plus type, whereby it is used to outsource circuits and reduce the amount of installation work and materials without its own battery.

The energy supply (AC / DC voltage) is realized through an outgoing sub-distributor in the main system.

Power is supplied by separate cables for the mains and battery voltage.

Switching from mains to battery voltage takes place separately in each circuit module.

Each sub-distributor is equipped with a UV controller on which an integrated mains monitoring system monitors the mains voltage at the MCUV.

### FACTS

<b>Version:</b>	Wall housing
<b>Dimensions:</b>	see systems list
<b>Protection category:</b>	IP20 (optional IP21, IP54, E30)
<b>Insulation class:</b>	I
<b>Energieanschluss:</b>	230 V AC ( $\pm 10\%$ ) 50/60Hz / 216 V DC
<b>Switched mode:</b>	230 V AC / 216 V DC $\pm 15\%$
<b>permissible Temp.:</b>	0°C to 35°C
<b>Cable feed:</b>	from Top (from below on request)

### FEATURES AT A GLANCE:

- Power supply system according to DIN EN 50171 for safety lighting systems according to DIN EN 50172 and systems according to DIN VDE 0100-718
- Max. 48 circuits of max. 1300 W.
- Status information of the system via StatusLEDs
- Data terminals for further wiring to other MCUV systems
- up to 6 switching inputs per circuit

#### Optional light switch query module SAM24M:

- 8x switching input on terminal (200 - 255 V AC or 24 - 255 V DC) for switching the circuits in AC operation
- 3 circuit types (sw. maintained, maintained, non-maintained) programmable

Version	Order number	Cabinet HxBxT in mm	Circuits	max. DCM
multiControl plus UV, UV-C	MCUV12	500x400x250	max. 12	6
multiControl plus UV, UV-C	MCUV12E30	678x581x345	max. 12	6
multiControl plus UV, UV-C	MCUV24	550x600x450	max. 24	12
multiControl plus UV, UV-C	MCUV24E30	1050x650x341	max. 24	12
multiControl plus UV, UV-C	MCUV36	900x600x450	mx. 36	18
multiControl plus UV, UV-C	MCUV36E30	1150x760x575	max. 36	18
multiControl plus UV, UV-C	MCUV48	900x600x450	max. 48	24

# CONNECTION DIAGRAM MC-UV / MC-US

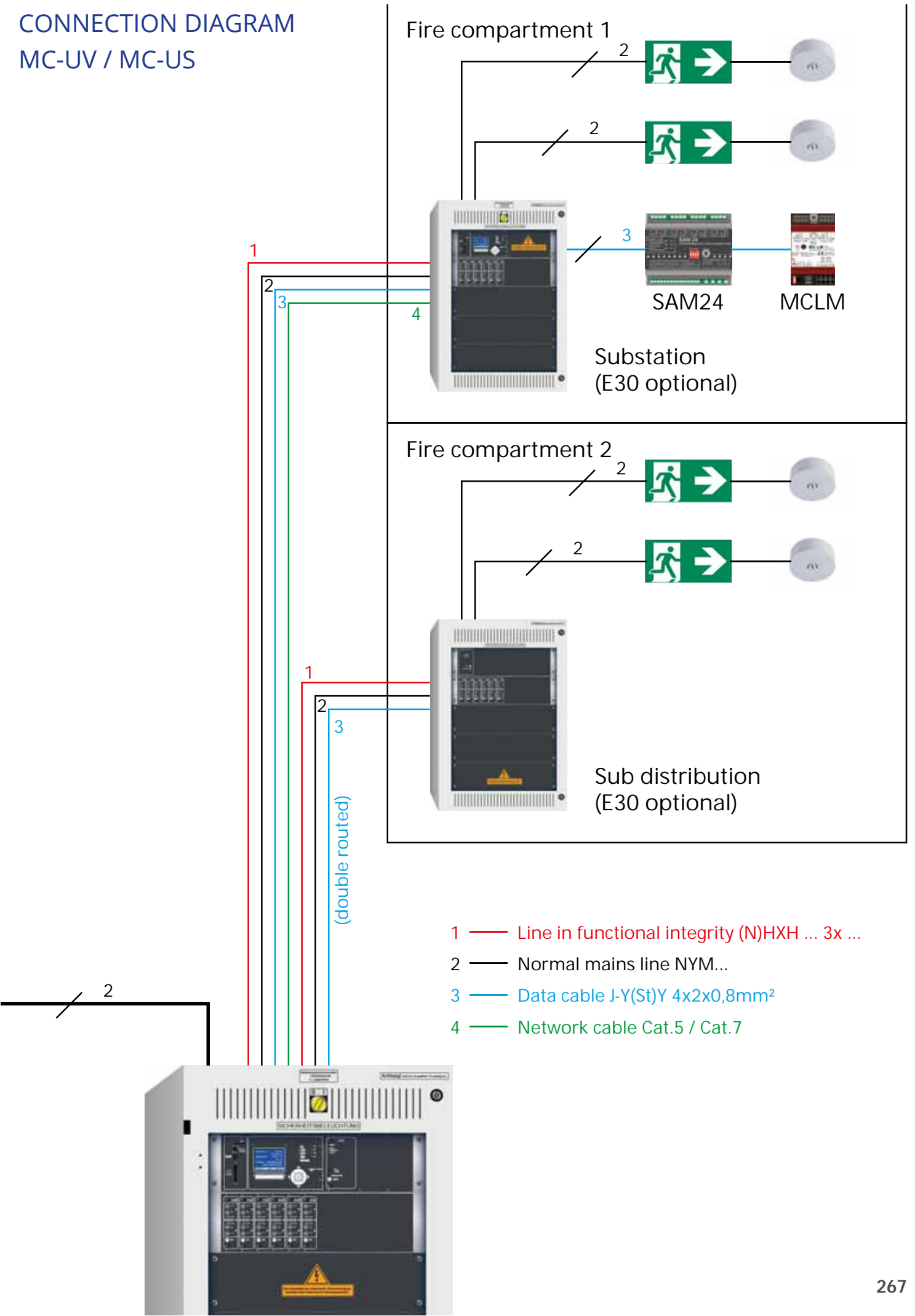

## SUBDISTRIBUTION - SINGLE CONDUCTOR TECHNOLOGY MCUV-E

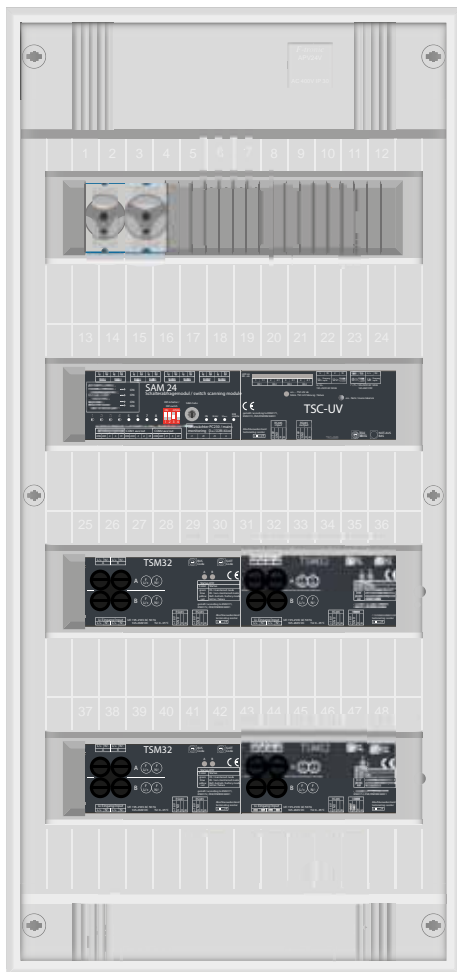

The MCUV-E is a system for connecting to main systems of the multiControl plus series, whereby it is used to outsource circuits and reduce installation effort / material without its own battery.

The energy supply (AC/DC voltage) is realized through an outgoing sub-distributor in the main system.

The energy is supplied in single-wire technology by an AC / DC switchover in the multiControl plus main system.

If the main system works in mains operation, the MCUV-E is supplied with AC voltage. The MCUV-E is supplied with DC voltage during battery or test operation of the main system.

In contrast to conventional systems with two supply lines (AC line and DC line), only one supply line (AC / DC line) is required, with which further savings in installation material can be achieved.

Each sub-distributor has four separate CCIFs, which means that four network monitor loops can be monitored individually on each MCUV-E.

An additional supply for energy supply from a local general light distributor is optionally available. This enables a tenant-related energy supply for the lights connected to the MCUV-E to be implemented. When the system is ready for operation, the luminaires are supplied by feeding the local general light distributor. The luminaires are only supplied by the main system if the general lighting distributor fails or if the main system has priority emergency or test operation.

Version	Order number	max. Mains circuits
MCUV-E02	UV multiControl plus ZBS, TSC-UV, 1x TSM32	2
MCUV-E02-LE	UV multiControl plus ZBS, TSC-UV, 1x TSM32, local feed	2
MCUV-E02-LE-SAM	UV multiControl plus ZBS, TSC-UV, 1x TSM32, local feed, incl. SAM24	2
MCUV-E04	UV multiControl plus ZBS, TSC-UV, 2x TSM32	4
MCUV-E04-LE	UV multiControl plus ZBS, TSC-UV, 2x TSM32, local feed	4
MCUV-E04-LE-SAM	UV multiControl plus ZBS, TSC-UV, 2x TSM32, local feed, incl. SAM24	4
MCUV-E06	UV multiControl plus ZBS, TSC-UV, 3x TSM32	6
MCUV-E06-LE	UV multiControl plus ZBS, TSC-UV, 3x TSM32, local feed	6
MCUV-E06-LE-SAM	UV multiControl plus ZBS, TSC-UV, 3x TSM32, local feed, incl. SAM24	6
...further configurations on request		

# CONNECTION DIAGRAM

## MCUV-E

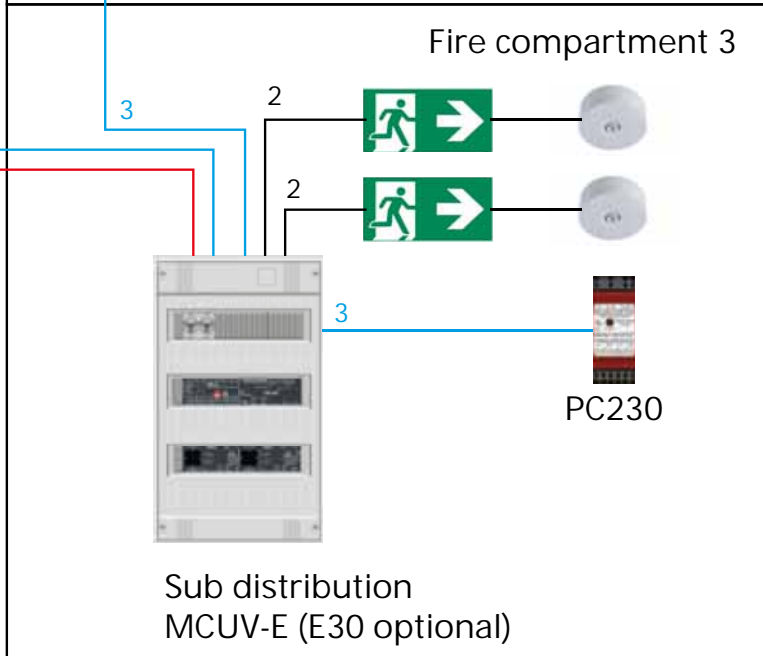
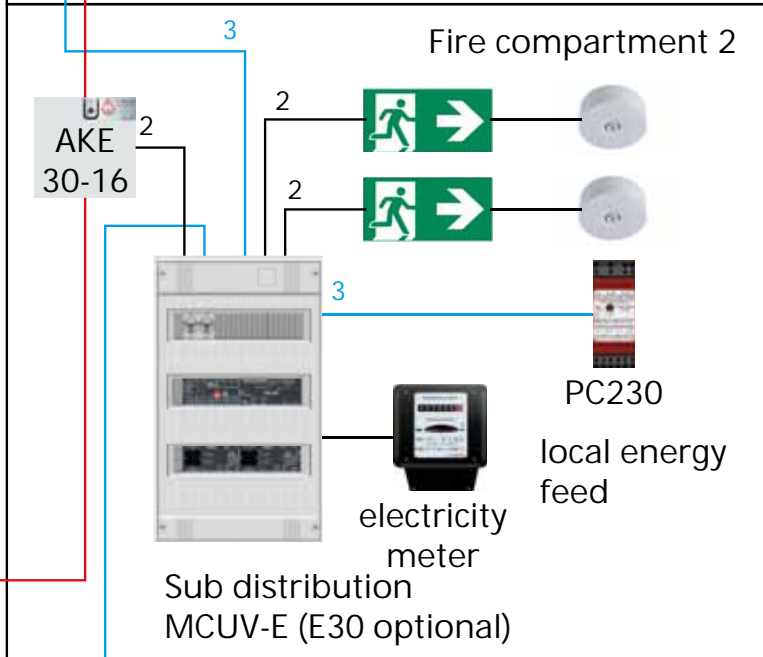
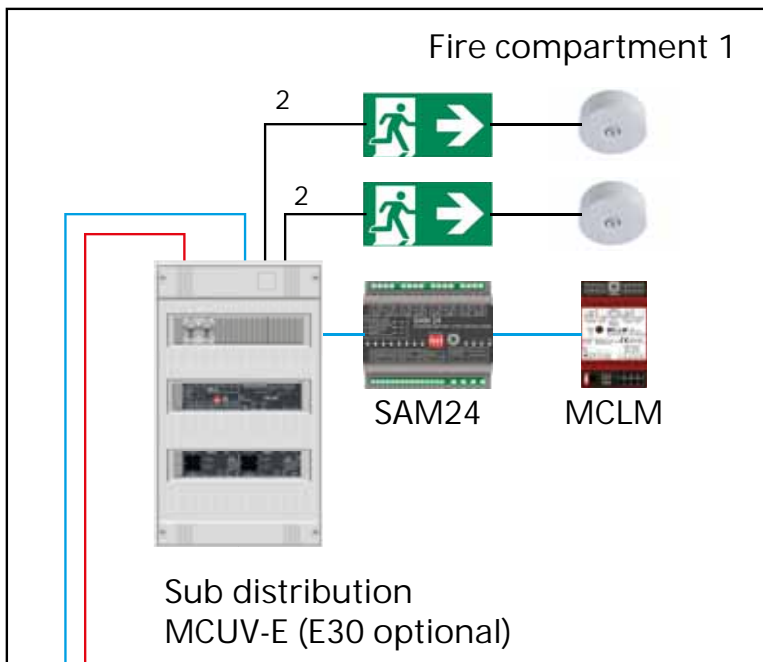
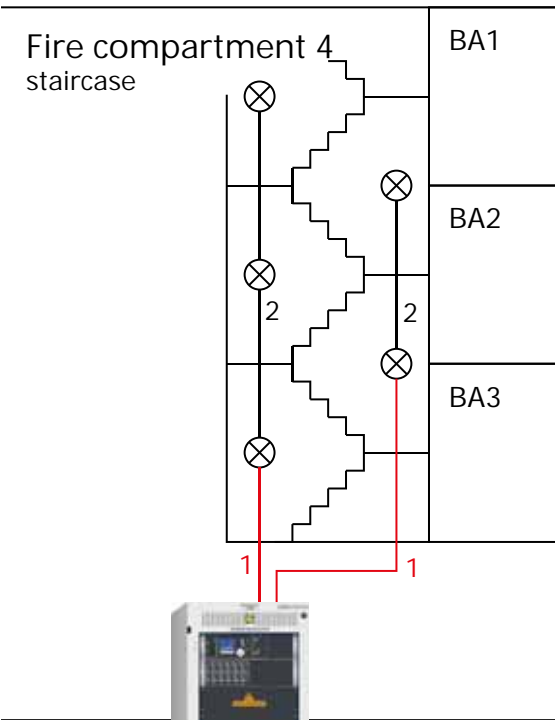

- 1 — Line in functional integrity (N)HXH ... 3x ...
- 2 — Normal mains line NYM...
- 3 — Data cable J-Y(St)Y 4x2x0,8mm<sup>2</sup>

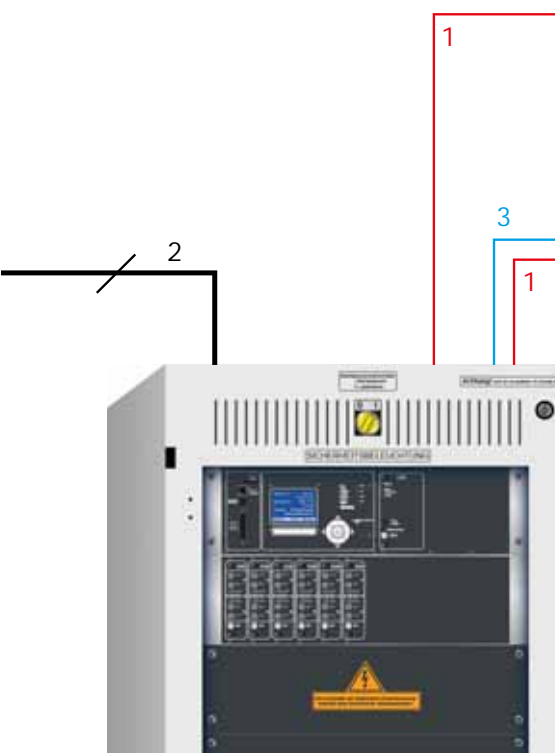

## RELATED ACCESSORIES BY SYSTEM TYPE

	myControl plus	microControl plus	miniControl plus	miniControl XL plus	midiControl plus	multiControl plus
SAM24	X	X	X	X	X	X
MC-LM	X	X	X	X	X	X
MCT15	X	X	X	X	X	X
PC230	X	X	X	X	X	X
DCM32		x	x	x	x	x
DCM42				x	x	x
DCM62						x
DCM12E		x	x	x	x	x
(zus.) RSM						x
CCIF						X
CCIF-RSM						X*
SAM24M						X*
zus. IOM						X*
BAT-LOGG				X	X	X
MCABUS						X*
MCABUV						X*
UVKOP						X*
ABUV-E60						X*
ABUV-E100						X*
ABUV-E						X*
IES-5P	X	X	X	X	X	X
IES-8P				X	X	X
MC-MODBUS1				X	X	X
MC-MODBUS2		X	X			
MC-MODBUS-RTU						X
MCBACNET1				X	X	X
MCBACNET2		X	X			
MC-COMCON		X	X	X	X	X
MC-XML	X	X	X	X	X	X
MI-WLAN	X	X	X	X	X	
MC-WLAN						X
MC-MSERV	X	X	X	X	X	X
MC-MSERVM				X	X	X
MCBD04E				X	X	X
BDEXT		X	X			
APIP54	X	X	X	X	X	X*
E30	X	X	X	X		X
PLX	X	X	X	X	X	X
LUINT120						X
LUAN1/2/3/4						X
SSD				X	X	X
SSIB						X
TFST						X*
ZSU						X
ABKL						X
APSI						X
PC230E					X	X
DBU25						X*
DBU40						X*
DBU60						X*
DBU75						X*
DBU90						X*
DBU100						X*
DBU150						X*
DBU200						X*
NE16						X*
...						X*
NE63						X*



	MDC	multiControl plus Unterstation	microControl plus Unterstation	multiControl plus Unterverteiler	multiControl plus Unterverteiler Einleitertechnik	*) Bemerkungen
SAM24	X	X	X		X	
MC-LM	X	X	X		X	
MCT15	X	X	X		X	
PC230	X	X	X		X	
DCM32		x	x	x		
DCM42		x		x		
DCM62		x		x		
DCM12E		x	x	x		
(zus.) RSM	x	x				
CCIF	X	X				
CCIF-RSM	X					in comb. w. RSM
SAM24M	X	X*		X (not MCUV12)		not E30
zus. IOM	X	X*				not E30
BAT-LOGG	X					
MCABUS	X					not E30
MCABUV		X*				not E30
UVKOP		X*				not E30
ABUV-E60		X*				not E30
ABUV-E100		X*				not E30
ABUV-E		X*				not E30
IES-5P	X	X	X			
IES-8P	X	X				
MC-MODBUS1	X	X				
MC-MODBUS2			X			
MC-MODBUS-RTU	X	X				
MCBACNET1	X	X				
MCBACNET2			X			
MC-COMCON	X	X	X			
MC-XML	X	X	X			
MI-WLAN			X			
MC-WLAN	X	X				
MC-MSERV	X	X	X			
MC-MSERVM	X	X				
M CBD04E	X	X				
BDEXT						
APIP54	X*	X	X			
E30	X	X	X	X	X	
PLX	X	X	X			
LUINT120	X	X				
LUAN1/2/3/4	X					
SSD	X	X				
SSIB	X	X				
TFST	X*	X*		X*		not E30
ZSU	X					
ABKL	X	X		X*		not E30
APSI	X	X		X*		not E30
PC230E	X	X				
DBU25	X					in comb. w. RSM
DBU40	X					in comb. w. RSM
DBU60	X					in comb. w. RSM
DBU75	X					in comb. w. RSM
DBU90	X					in comb. w. RSM
DBU100	X					in comb. w. RSM
DBU150	X					in comb. w. RSM
DBU200	X					in comb. w. RSM
NE16	X					in comb. w. DBU
...	X					in comb. w. DBU
NE63	X					in comb. w. DBU



DCM32 / DCM42 / DCM-E

The **DCM circuit module**, in service-friendly 19" plug-in technology, is used for the voltage supply and monitoring of safety and escape sign luminaires. The circuit module is equipped with two circuits, each with a separate fuse. Each circuit has its own AC / DC switchover.

The **TSM32 circuit module**, in a compact cabinet for mounting on mounting rails, is used for power supply and monitoring of safety and escape sign luminaires. The circuit module is equipped with two circuits, each with a separate fuse. The AC / DC switchover takes place centrally in the main system.

Each circuit module offers the possibility of implementing individual luminaire monitoring of up to 20 luminaires and / or self-calibrating circuit monitoring per circuit.

The operation of continuous light, standby light and switched continuous light is possible. The circuit module monitors the connected luminaires or the circuit for: luminaire faults, current faults and circuit faults. A status query of the module on the system display is possible. The DCM has two status LEDs for status display, the TSM32 a multi-mobile status LED.

Circuit modules of type DCM12E additionally have the function of switching individual lights.



DCM62

The following circuit modules are available for different output powers:

Type	Fusing	maximum Load
DCM12E	2x F5A	2x 250 W
DCM 32	2x F5A	2x 650 W
DCM 42	2x F6,3A	2x 860 W
DCM 62	2x FF10A	2x 1300 W
TSM32	2x F5A	2x 650 W



TSM32

## RELAY CIRCUIT MODUL, CHARGER MODULE

The **relay switching module RSM** is used to control up to two contactor switches, for the energy supply of safety and escape sign luminaires, primarily in systems of the MDC type.

The RSM has two separate contacts for switching the contactor changeovers. In addition, a separate CCIF is integrated for each contactor changeover.

Further switching options are available via SAM24 or MC-LM, e.g. switched continuous light or network monitor functions.

Different run-on and supply times can be programmed separately for each contactor changeover.

The RSM has a multi-colored status LED for status display.



The **LDM25 charging module**, in service-friendly 19" plug-in technology, is used to charge battery sets in power supply systems in accordance with the applicable European and national standards.

The LDM25 has its own charge control and works with an IUTQ characteristic according to EN 50272-2.

Optimal battery life is ensured by taking current, voltage and ambient temperature into account.

The charging current of the LDM25 can be configured to 0.5 A, 1.0 A or 2.5 A depending on the system requirements.

The charging voltage of the LDM25 can be configured depending on the battery type (NiCd; OGI / OPzS / OPzV or OGIV), regardless of the charging current.

The LDM25 has four status LEDs for status display.



## IO-MODULE, LIGHT SWITCH QUERY MODULE



The **IO module** for forwarding system states to an external display unit or building management system via 7 potential-free contacts. In addition, 4 potential-free polarity-tolerant switching inputs are integrated.

The IO module has status LEDs for status display.



The **switch query module SAM24** is used to transmit voltage levels of general lighting to safety lighting systems of the multiControl plus series.

The evaluation of up to 8 switching inputs enables the additional switching of safety and escape sign luminaires of the safety lighting system together with the general light. An integrated 3-phase network monitor input enables the monitoring of a general light distributor.

Applying a 230 V AC voltage to U / BUS COM-boost (L3 / N of the network monitor input) prepares the BUS voltage for the module itself and all subsequent modules in the BUS. This makes it possible to compensate for losses in the BUS voltage.

The COM1 output is used for through-wiring the RS485BUS. An additionally generated RS485BUS can be tapped at the COM2 output of the SAM24. Independent of the COM1 output, an additional spur line can be implemented to connect modules to the BUS.

The SAM24 has status LEDs for status display.

Note: The connection of multiControl plus sub-distributors of type MCVU-E is only permitted at output COM1 of SAM24.

## » CLOSED CURRENT LOOP, LINE MONITOR

The **CCIF module** (critical circuit interface module) is designed for use in devices of the type multiControl plus and MDC and ensures reliable monitoring of a network monitor loop in connection with network monitor modules of the type PowerControl PC230.

The emergency mains operation (mod. Standby) is triggered in the event of an interruption or clumping / short-circuiting of the network monitor loop and is signaled in the system's LCD with a „critical circuit“.

Cables to maintain the function for the network monitor loop are not necessary. A status LED signals the closed current loop.



The **three-phase line monitoring PC230** is used to monitor AV networks (power supply for general lighting).

A maximum of 3 phases + neutral conductors can be monitored with the PC230. The switching threshold for the detection of a power failure or a power fluctuation is 85% of the nominal power UNENN.

Two potential-free changeover contacts are used to connect to the safety lighting system.

The PC230 has a status LED for status display.



The **MC-LM bus mains monitor** (multiControl plus - Line Monitor V2) is used to monitor AV networks (power supply for general lighting).

The MC-LM is connected to safety lighting systems of the multiControl plus series via a secure RS485BUS and does not require a data line to maintain its function.

A maximum of 3 phases + neutral conductor can be monitored with the MC-LM. The switching threshold for the detection of a power failure or a power fluctuation is 85% of the nominal power UNENN.

From version V2, a potential-free relay contact enables cross-system switching, for example.

The MC-LM has a multi-colored status LED for status display.



The **MC-FLM** is a module for monitoring a local AV network and switching luminaires / lighting groups. Each MC-FLM forms its own lighting group and enables the lighting of this group to be switched together, e.g. together with the general light.

An integrated network monitor and switching input enable switching of the lights / lighting group.  
The MC-FLM and the lighting group are powered by the circuit module of the safety lighting system.

The MC-FLM has a multi-colored status LED for status display.

No image yet

The **MCT15 (S / U / US) remote panel** is used for the decentralized display of states of safety lighting systems of the multiControl plus series.

The corresponding status of the system is displayed optically and acoustically. The visual display is via plain text and LED. If faults occur, there is also an acoustic message.

This remote panel is optionally available with a button (MCT15 / MCT15U) or key switch (MCT15S / MCT15US) as a mode selector switch. There are also cabinet variants for surface mounting (MCT15 / MCT15S) and flush mounting (MCT15U / MCT15US) to choose from.

In plain text, the display provides information about the following status information of the safety light system:

- Battery voltage
- Mains voltage
- Battery ambient temperature
- System errors and much more

A multi-colored status LED and a red error LED signal the following system states:

- System ready for operation / loading operation
- Battery / mains operation
- Continuous light on / off
- System error

In the event of a fault, an acoustic signal sounds.



	MCT-15/MCT-15S	MCT-15U / MCT-15SU
Dimensions in mm	117 x 117 x 26 (H x B x T)	Cut-out 120x120mm

# CONNECTION TO BUILDING MANAGEMENT SYSTEM

The building management system gateway forms a defined interface between building management system and central power supply systems for emergency lighting. Thus, all system and luminaire information is directly available in the building management system.

The MC-BMS controller ensures that all information from the connected emergency lighting system is read out and made accessible to the outside via ModBus or BACnet. It automatically detects which protocol is supported by the connected building management system.

Until now, one controller per system was required for this. With the MC-BMS, this is possible with only one controller for a total of 33 networked systems. Depending on the system type, it is installed directly in the control cabinet of the emergency lighting system (MC-BMSM) or in an external housing (MC-BMS-EXT).



### MC-BMS-ACT

Activation of the interface function per system.

### MC-BMSM

Controller integrated in emergency lighting system. Interface function activated in the main system at the factory.

An additional activation of the interface function is required for each additional system to be queried (MC-BMS-ACT).

### MC-BMS-EXT

Controller in external housing. An additional activation of the interface function is required for each system to be queried (MC-BMS-ACT).

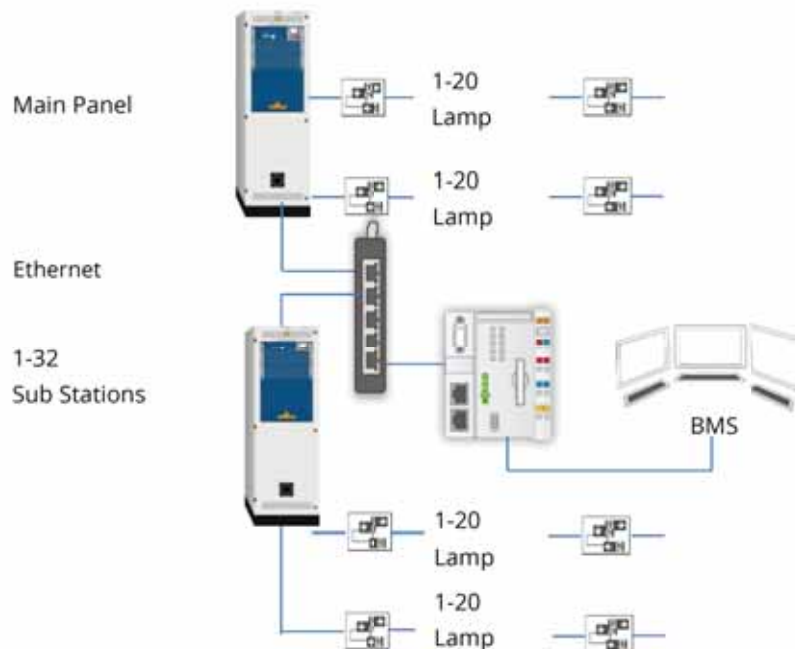



Power down switch **UW220** or **UW500** for the operation with inverter devices (electronic ballast with 1 feeding AC/DC) at central power supply systems about 2 incoming wires. Max. switchover performance 250 or 500VA. Alternation voltage can be switched about the light switch of the room light as well as the AC/DC-voltage about the central supply power system. Time-delayed emergency entry with previous disconnection of the main input.

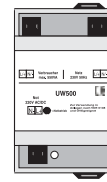
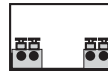

### Connection UW

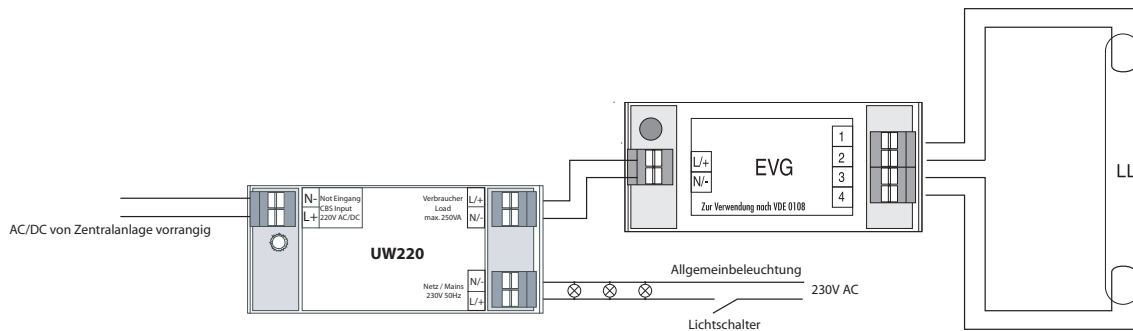



The **MU05** module is an addressable controller for use in a safety luminaire. This controller offers all switching modes and can operate a single luminaire survey. Consumers can be monitored without an auxiliary line. The general advantages are:

- compact design
- consumers load 4 up to 200 VA
- 2,5 mm<sup>2</sup> connectors with bypass connection (to safety power supply system)
- local power supply monitoring
- S S' disable external dimming voltage

The power supply monitor allows connected luminaires being operated in maintained and non-maintained mode. In case of a general mains failure all luminaires are switched on.

The MU05 is designed to work with power supply systems of the multiControl plus series.

Dimensions: H=22mm, W=29mm, D=142mm.



The **housing UH1** is a universal plastic housing for accommodating the luminaire modules LPU, MLED, MU05 and NT24.

The UH1 can easily be installed through a standard ceiling cut with 74mm in a cavity ceiling. The installation depth required minimum amounts to only 100mm, because the rear part of the housing can be bent up to an angle of 45°.

UH1 allows a terminal for connection of 2.5 mm<sup>2</sup> wires to install. Strain reliefs are provided on both ends of the housing.

For concrete installation, we recommend the recessed boxes HaloX-0 + HaloX-40 from Kaiser.

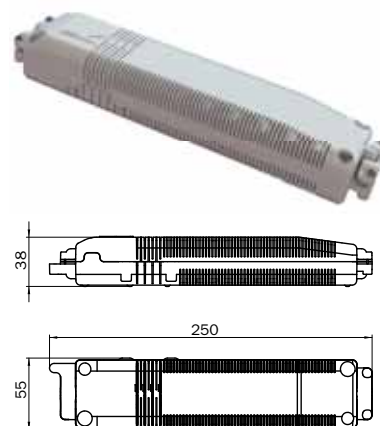

The **MU05-Box** is a plastic housing that holds the luminaire monitoring module MU05. The housing is designed in IP65 and holds the necessary terminal connectors in addition to the luminaire module.

Thus, a use of the luminaire monitoring device MU05 in humid mounting situations is possible.

Dimensions: 176 x 130 x 76mm

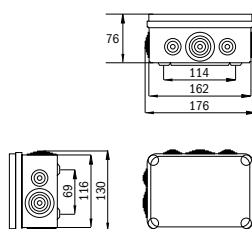



The image shows a rectangular electronic module with a white plastic housing. It features a green terminal block at the bottom with six terminals. The top surface has a red emergency stop button and a green LED indicator. The main body is black with white printed text and a circular potentiometer. The text includes technical specifications and safety information in both German and English.



The logo consists of the letters 'LED' in a stylized font, with the number '24' to its right, all enclosed in a diamond-shaped border.

The MLED500 is an electronic switching power supply with integrated individual light monitoring, light management function, mains monitoring, dimmer and flashing functions. All switching modes are possible. The mains monitor allows the operation of connected luminaires in non-maintained mode in a maintained circuit. In case of a mains failure all lights are switched on automatically. LED illuminants with a max. output of 8W can be used as consumers.

The MLED500 is also capable of dimming the lights to 30% or 50% (cinema mode) in mains operation and to execute a flashing function in emergency operation (e.g. underground car park).

The MLED500 is suitable for use with emergency lighting systems of the multiControl plus series.

Dimensions: 143 x 38 x 27mm

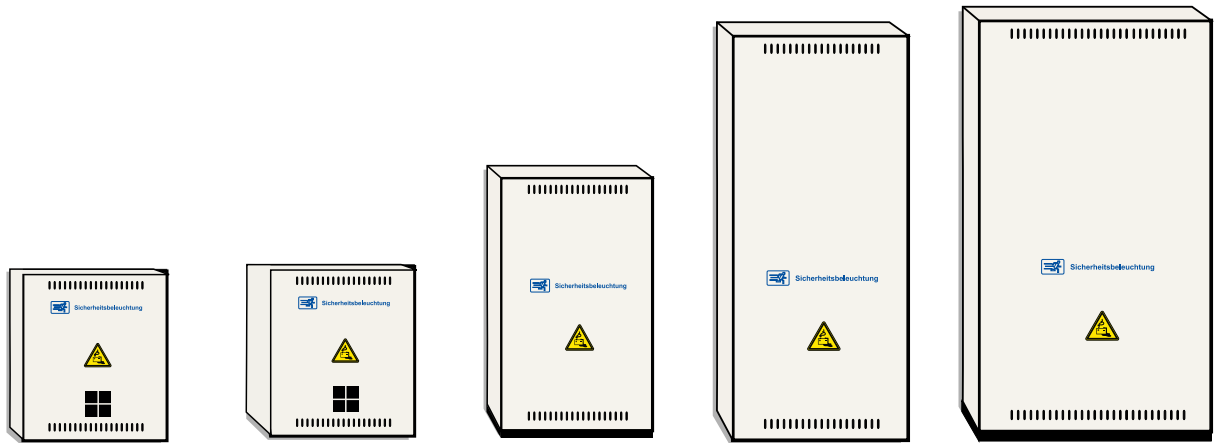

Cabinet	BATT90	BATT60	BATT11	BATT18	BATT20
Cabinet	Wall or Tower housing, door stop left	Wall or Tower housing, door stop left	Wall or Tower housing, door stop left, incl. 50mm socket	Tower housing, door stop left	Tower housing, door stop left, incl. 50mm socket
Stahlblechgehäuse	RAL 7035, IP20	RAL 7035, IP20	RAL 7035, IP20	RAL 7035, IP20	RAL 7035, IP20
Abmessungen in mm	900 x 600 x 450	900 x 600 x 600	1100 x 600 x 450	1800 x 600 x 450	1850 x 800 x 600
Kabeleinführung	Top insertion	Top insertion	Top insertion	Top insertion	Top insertion
Bestellnummer Oder number	BATT90	BATT60	BATT11	BATT18	BATT20
<b>Optional:</b>	Door stop right Socket 100mm Socket 200mm	Door stop right Socket 100mm Socket 200mm	-	Door stop right Socket 100mm Socket 200mm	-

The integrated ventilation slots are designed for the maximum possible battery capacity.

## BATTERIES – OGIV LP

In case of emergency the safety and rescue sign luminaires are powered by maintenance free acid batteries of type OGIV in all emergency light systems. These are designed according to DIN EN IEC 62485-2 and DIN EN 50171.

The designed lifetime of these batteries is in 20° C ambient temperature up to 12 years.



### Output for OGIV batteries (calculated with a set of 18 batteries)

Typ	OGiV 1252 LP	OGiV 1270 LP	OGiV 1290 LP	OGiV 12120 LP	OGiV 12170 LP	OGiV 12260 LP	OGiV 12280 L	OGiV 12330 LP	OGiV 12400 LP	OGiV 12450 LP	OGiV 12550 LP
Battery capacity Ah	5	7	9	12	17	26	28	33	40	45	55
Output max. 1h in W*	864 (691)	893 (715)	1.134 (907)	1.674 (1.339)	2.430 (1.944)	3.240 (2.592)	3.143 (2.514)	4.136 (3.309)	5.044 (4.035)	5.648 (4.519)	7.353 (5.883)
Output max. 3h in W*	346 (276)	355 (284)	501 (401)	674 (539)	944 (755)	1.501 (1.201)	1.544 (1.236)	1.642 (1.313)	2.117 (1.693)	2.376 (1.901)	3.256 (2.604)
Output max. 8h in W*	130 (104)	164 (131)	205 (164)	287 (230)	423 (339)	653 (523)	711 (569)	786 (629)	872 (697)	1.051 (841)	1.580 (1.264)

### Number of cabinets needed for a set (18 pcs) of batteries of the entire capacity

MC-Cabinet 1000mm	1	1	1	1	1	-	-	-	-	-	-
MC-Cabinet 1500mm	1	1	1	1	1	1	1	1	1	1	-
Battery cabinet BATT90 900 x 600 x 450mm	1	1	1	1	1	1	1	1	1	1	1
Battery cabinet BATT60 900 x 600 x 600mm	1	1	1	1	1	1	1	1	1	1	1
Battery cabinet BATT11 1100 x 600 x 450mm	1	1	1	1	1	1	1	1	1	1	1
Battery cabinet BATT18 1800 x 600 x 450mm	1	1	1	1	1	1	1	1	1	1	1
Battery cabinet BATT20 1850 x 800 x 600mm	1	1	1	1	1	1	1	1	1	1	1

### Required air circulation per battery set (calculated for power charging of the batteries)

Air stream with technical ventilation at least (m³/h)	0,3	0,4	0,4	0,6	0,8	1,2	1,3	1,5	1,8	2,0	2,4
Profile of the air inlet pipe with natural ventilation (cm²)	8,4	11,2	11,2	16,8	22,4	33,6	36,4	42	50,4	56	67,2

\* Performance ratings with 25% aging Reserve in parantheses

OGiV 12600 LP	OGiV 12650 LP	OGiV 12750 LP	OGiV 12800 LW	OGiV 12800 LPL	OGiV 12900 LP	OGiV 121000 LP	OGiV 121200 LPS	OGiV 121200 LP	OGiV 121340 LP	OGiV 121500 LP	OGiV 122000 LPE	OGiV 122000 LP	OGiV 122600 LP
60	65	75	80	80	90	100	120	120	134	150	200	200	260
7.420 (5.936)	7.852 (6.281)	9.094 (7.275)	9.288 (7.430)	9.558 (7.646)	10.260 (8.208)	12.744 (10.195)	14.364 (11.491)	15.660 (12.528)	16.200 (12.960)	18.360 (14.688)	24.624 (19.699)	26.892 (21.514)	28.944 (23.155)
3.262 (2.609)	3.359 (2.687)	4.104 (3.283)	4.104 (3.283)	4.212 (3.370)	4.666 (3.732)	5.238 (4.190)	5.746 (4.596)	6.318 (5.054)	7.366 (5.892)	7.700 (6.160)	9.979 (7.983)	11.988 (9.590)	13.284 (10.627)
1.440 (1.152)	1.540 (1.232)	1.814 (1.452)	1.998 (1.598)	1.912 (1.529)	2.128 (1.702)	2.462 (1.970)	2.700 (2.160)	2.808 (2.246)	3.175 (2.540)	3.532 (2.825)	4.752 (3.802)	5.400 (4.320)	5.616 (4.493)
-	-	-	-	-	-	-	-	-	-	-	-	-	-
-	-	-	-	-	-	-	-	-	-	-	-	-	-
-	-	1	-	-	-	-	-	3	3	3	-	-	-
1	-	1	1	-	-	-	-	2	-	-	-	3	-
-	-	-	-	-	-	-	-	3	3	3	-	-	-
1	1	1	1	1	1	1	1	2	2	2	3	3	3
1	1	1	1	1	1	1	1	1	1	1	1	1	2
2,6	2,9	3,3	3,5	3,5	3,9	4,4	5,2	5,2	5,8	6,5	8,7	8,7	11,3
72,8	81,2	92,4	98	98	109,2	123,2	145,6	145,6	162,4	182	243,6	243,6	316,4

GENERAL  
INFORMATIONS

LOW POWER SYSTEMS

CENTRAL BATTERY SYSTEMS

SUBSTATIONS AND  
SUBDISTRIBUTIONS

ACCESSORIES AND MODULES

BATTERIA AND  
BATTERY MONITORING

## OGIV LONG-LIFE-SERIES (DESIGN LIFE UP TO 12 YEARS)

RPower® Typ	Voltage	Capacity	Dimensions (*= incl. Poles)			Weight	Pol	Connector
	V	Ah	L	B	H*	kg	Terminal	
OGIV1252LP	12	5,2	90	70	107	1,90	6,3mm	2,5 mm <sup>2</sup>
OGIV1270LP	12	6,9	151	65	100	2,37	6,3mm	2,5 mm <sup>2</sup>
OGIV1290LP	12	8,8	151	65	100	2,78	6,3mm	2,5 mm <sup>2</sup>
OGIV12120LP	12	11,8	151	98	101	3,67	6,3mm	2,5 mm <sup>2</sup>
OGIV12170LP	12	16,8	181	77	167	5,5	M5	6 mm <sup>2</sup>
OGIV12260LP	12	25,6	166	175	125	9,2	M5	6 mm <sup>2</sup>
OGIV12280L	12	29,7	165	125	175	9,1	M5	6 mm <sup>2</sup>
OGIV12330LP	12	34,6	195	130	168	11	M6	16 mm <sup>2</sup>
OGIV12400LP	12	42,2	197	165	170	13,8	M6	16 mm <sup>2</sup>
OGIV12450LP	12	47,2	197	165	170	14,6	M6	16 mm <sup>2</sup>
OGIV12550LP	12	61,0	229	138	213	17,2	M6	16 mm <sup>2</sup>
OGIV12600LP	12	62,0	258	166	215	20,7	M6	16 mm <sup>2</sup>
OGIV12650LP	12	67,2	350	167	179	22,4	M6	16 mm <sup>2</sup>
OGIV12750LP	12	81,0	258	166	215	22,5	M6	16 mm <sup>2</sup>
OGIV12800LW	12	84,0	260	168	214	22,4	M6	16 mm <sup>2</sup>
OGIV12800LPL	12	84,0	350	167	179	22,5	M6	16 mm <sup>2</sup>
OGIV12900LP	12	93,4	306	169	216	26,5	M6	16 mm <sup>2</sup>
OGIV121000LP	12	106,0	330	171	222	32	M8	25 mm <sup>2</sup>
OGIV121200LPS	12	124,9	330	171	222	32,5	M8	25 mm <sup>2</sup>
OGIV121200LP	12	127,2	410	176	224	36	M8	25 mm <sup>2</sup>
OGIV121340LP	12	140,8	341	173	287	39,5	M8	25 mm <sup>2</sup>
OGIV121500LP	12	157,6	482	170	240	44,8	M8	25 mm <sup>2</sup>
OGIV122000LPE	12	208,2	522	238	223	59,1	M8	25 mm <sup>2</sup>
OGIV122000LP	12	208,8	522	238	223	67,5	M8	25 mm <sup>2</sup>
OGIV122600LP	12	260,0	520	269	227	74	M8	25 mm <sup>2</sup>



## ➤ BATTERIES – OGIV FT

In case of emergency the safety and rescue sign luminaires are powered by maintenance free acid batteries of type OGIV in all emergency light systems. Front terminal (FT) batteries have the advantage that they are - installed in a suitable cabinet - are accessible from the front. This simplifies the installation and service considerably.

The designed lifetime of these batteries is in 20° C ambient temperature up to 12 years and more.



### Output for OGIV batteries (calculated with a set of 18 batteries)

Typ	OGiV 12550 FT	OGiV 12800 FT	OGiV 121500 FTP
Battery capacity Ah	55	80	150
Output max. 1h in W*	7.182 (5.746)	9.688 (7.750)	18.144 (14.515)
Output max. 3h in W*	3.056 (2.445)	4.093 (3.275)	8.770 (7.016)
Output max. 8h in W*	1.436 (1.149)	1.955 (1.564)	3.607 (2.886)

### Number of cabinets needed for a set (18 pcs) of batteries of the entire capacity

Combi cabinet MCX 1850 x 800 x 600mm	1	1	1
Battery cabinet BATT18 1800 x 600 x 450mm	1	-	-
Battery cabinet BATT20 1850 x 800 x 600mm	1	1	1

### Required air circulation per battery set (calculated for power charging of the batteries)

Air stream at least (m <sup>3</sup> /h)	2,4	3,5	6,5
Profile of the air inlet pipe (cm <sup>2</sup> )	67,2	98,0	182,0

\* Performance ratings with 25% aging Reserve in parantheses



# OGIV FT – TECHNICAL SPECIFICATIONS

## OGIV FRONT-TERMINAL-SERIES (DESIGNLIFE UP TO 12 YEARS AND MORE)

RPower® Typ	Voltage	Capacity	Dimensions (* = incl. Poles)			Weight	Pol	Position
	V	Ah	L	B	H*	kg	Terminal	
OGIV12550FT	12	58,2	277	106	222	17,3	M6	E
OGIV12800FT	12	79,4	564	114	187	26	M6	E
OGIV121500FTP	12	157	548	105	316	45,5	M8	E



A



B



C



D



E



F

## BATTERIES – OGIV HP

- Excellent high current discharge performance
- Flame retardant according to UL94-V0
- Reduced internal resistance and oversized inner cell connectors
- long service life in stand-by operation
- Impact- and break-proof plastic case made of ABS
- electrolyte is bound in fiberglass fabric (AGM = Absorbent Glass Mat Technology)
- maintenance-free operation in any position, except head first

### Output for OGIV batteries (calculated with a set of 18 batteries)

Typ	OGIV 12930 HP	OGiV 121250 HP	OGiV 121600 HP	OGiV 122500 HP	OGiV 123000 HP	OGiV 123400 HP	OGiV 123500 HP	OGiV 123600 HP	OGiV 123900 HP	OGiV 124100 HP	OGiV 125000 HP	OGiV 126000 HP
<b>Battery capacity Ah</b>	<b>28</b>	<b>35</b>	<b>58</b>	<b>80</b>	<b>94</b>	<b>110</b>	<b>126</b>	<b>140</b>	<b>150</b>	<b>156</b>	<b>200</b>	<b>230</b>
<b>Output max. 1h in W*</b>	4.180 (3.344)	5.627 (4.501)	7.463 (5.970)	11.448 (9.158)	12.420 (9.936)	12.852 (10.282)	14.688 (11.750)	17.820 (14.256)	18.900 (15.120)	19.548 (15.638)	24.300 (19.440)	28.080 (22.464)
<b>Output max. 3h in W*</b>	1.760 (1.408)	2.369 (1.895)	3.142 (2.513)	4.820 (3.856)	5.229 (4.183)	5.411 (4.329)	6.184 (4.947)	7.502 (6.002)	7.957 (6.366)	8.230 (6.584)	10.230 (8.184)	11.822 (9.457)
<b>Output max. 8h in W*</b>	827 (661)	1.113 (890)	1.476 (1.181)	2.265 (1.812)	2.457 (1.965)	2.542 (2.034)	2.905 (2.324)	3.525 (2.820)	3.739 (2.991)	3.867 (3.093)	4.807 (3.845)	5.555 (4.444)

### Number of cabinets needed for a set (18 pcs) of batteries of the entire capacity

<b>Combi cabinet MCX</b> 1850 x 800 x 600mm	1	1	1	-	-	-	-	-	-	-	-	-
<b>Battery cabinet BATT18</b> 1800 x 600 x 450mm	1	1	1	1	1	1	2	2	2	2	3	3
<b>Battery cabinet BATT20</b> 1850 x 800 x 600mm	1	1	1	1	1	1	1	1	1	1	1	1

### Required air circulation per battery set (calculated for power charging of the batteries)

<b>Air stream at least</b> (m <sup>3</sup> /h)	1,3	1,6	2,6	3,5	4,1	4,8	5,5	6,1	6,5	6,8	8,7	10
<b>Profile of the air inlet</b> pipe (cm <sup>2</sup> )	36,4	44,8	72,8	98,0	114,8	134,4	154	170,8	182	190,4	243,6	280

\* Performance ratings with 25% aging Reserve in parantheses

# OGIV HP – TECHNICAL SPECIFICATIONS

## OGIV PREMIUM HIGH-POWER-SERIES (DESIGN LIFE UP TO 12 JAHRE)

RPower® Typ	Voltage	Capacity	Dimensions (* = incl. Poles)			Weight	Pol	Position
	V	Ah	L	W	H*	kg	Terminal	
OGIV12930HP	12	28	165	125	175	9,6	M5	D
OGIV121250HP	12	35	195	130	168	11,5	M6	C
OGIV121600HP	12	58	229	138	213	17	M6	C
OGIV122500HP	12	80	258	166	215	24,5	M6	C
OGIV123000HP-M8	12	94	306	169	215	28,5	M8	C
OGIV123400HP-M8	12	110	330	171	220	31,5	M8	C
OGIV123500HP-M8	12	126	410	176	224	36,5	M8	C
OGIV123600HP-M8	12	140	341	173	287	39,5	M8	C
OGIV123900HP-M8	12	150	341	173	287	41	M8	C
OGIV124100HP	12	156	482	170	240	45	M8	C
OGIV125000HP	12	200	530	209	220	58	M8	E
OGIV126000HP	12	230	522	238	223	67	M8	E



A



B



C



D



E



F

# **BAT-LOGG® – BATTERY MONITORING FOR CENTRAL BATTERY SYSTEMS**

---

Regularly monitoring the battery condition helps to detect defects in time in order to replace defective batteries before they cause damage to the remaining ones.

But let's face it: Nobody likes to tamper with a multitude of batteries in narrow space. That's reason enough to consider introducing an automatic monitoring system, especially as the amendment standard EN 50171 requires that battery conditions be checked every 5 minutes... e.g. using BAT-LOGG®!

BAT-LOGG® is an automatic monitoring system for batteries which checks and logs the status of each single battery block in a system in short time intervals. By doing so, BAT-LOGG® not only contributes to the safety and reliability of the system, but also helps to reduce maintenance efforts and costs. BAT-LOGG® was specifically designed for easy installation in narrow locations, and is also extremely cost-saving thanks to its minimalist design.

## **How it works**

BAT-LOGG® Sensor modules measure the voltage and temperature of each battery. Each module is simply connected to the poles of a battery and glued to the battery case in order to measure its temperature reliably.

The measurement data is transmitted over the power line to a BAT-LOGG® Interface module. The module checks all measurement values and generates an error message if one or more of them lie outside the preset limits. Further, a potential-free relay contact notifies of any error event (collective fault).

The control unit of the power supply system retrieves all measurement data and error messages via a serial communication port and stores them. Messages and data regarding each battery, including current measurement values and data log, can be viewed using the system's LCD panel and Web-Interface.

**Monitors and stores voltage and temperature  
without additional wiring**



**BAT-LOGG® Sensor**  
(Dimensions: 38x34x10mm)

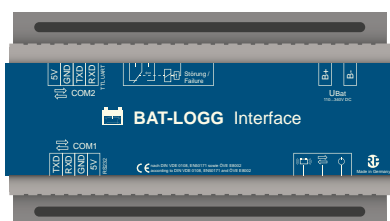

**BAT-LOGG® Interface**  
(DIN rail module: 156x86x58mm)

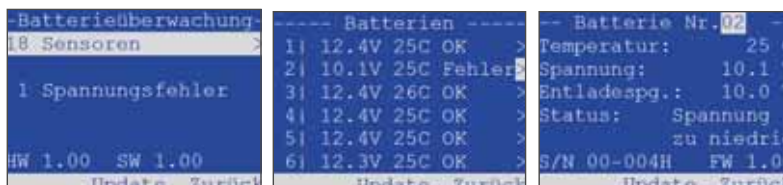

Measurement data display

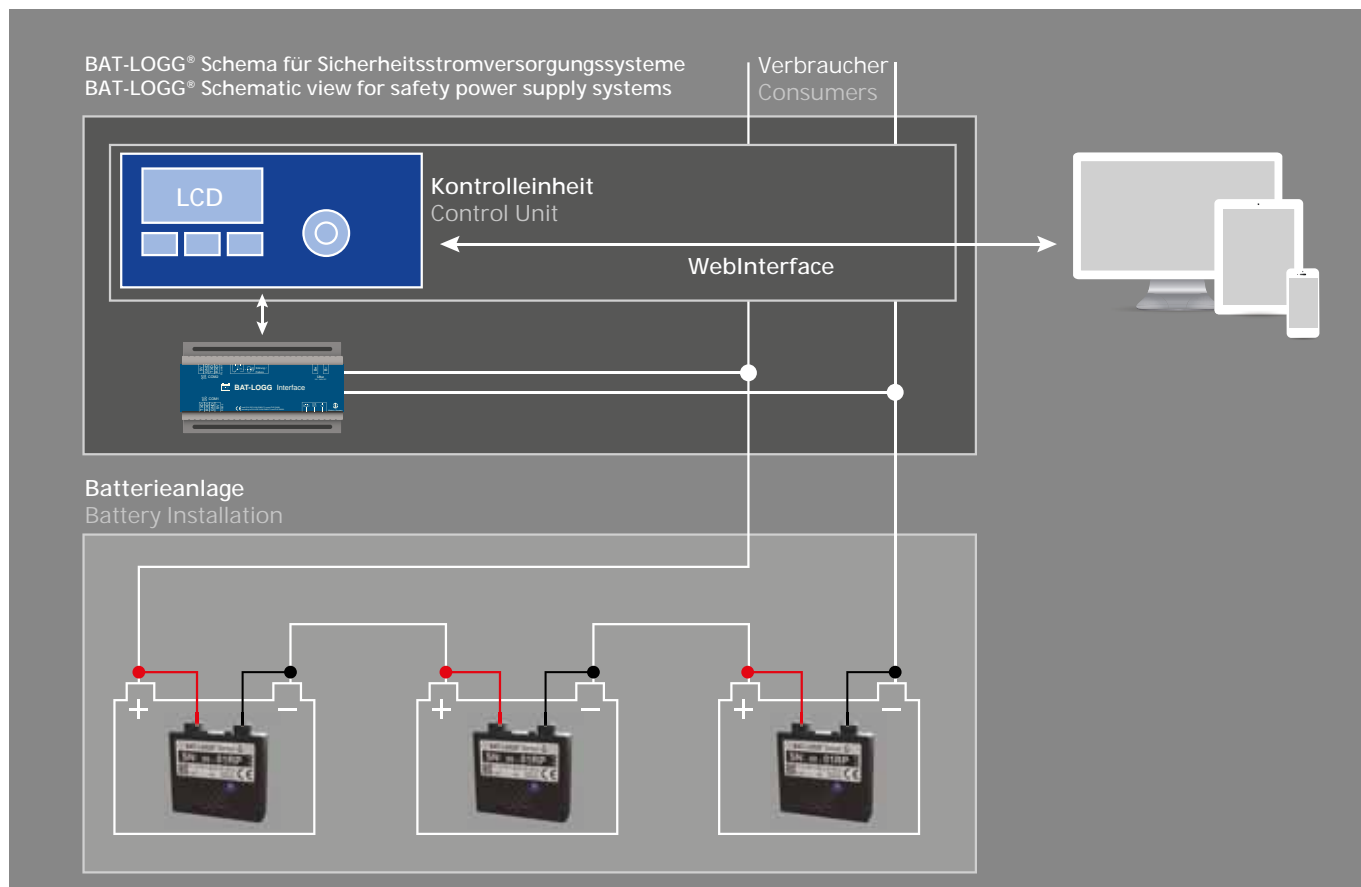

# BAT-LOGG® SYSTEM SPECIFICATIONS

Monitored battery type	Lead-acid batteries with 12V block voltage (nominal)
Maximum system voltage	800V DC
Voltage measurement range (accuracy)	9.0 ... 16.0 V ( $\pm 0.1$ V)
Temperature measurement range (accuracy)	0°C ... 60°C ( $\pm 3$ °C)
Max. number of sensors supported	max. 160 BAT-LOGG® Sensor modules
Measured values	<ul style="list-style-type: none"> <li>• battery voltage</li> <li>• battery temperature <sup>1)</sup></li> <li>• discharging voltage <sup>2)</sup></li> </ul>
Measuring frequency	once per 15-20 seconds
Data logging functions <sup>3)</sup>	<ul style="list-style-type: none"> <li>• once a day, minimum and maximum value of voltage and temperature over the last 24 hours, and status information on each battery</li> <li>• upon each test: measurement values taken before and after the test, including discharging voltage of each battery</li> </ul>
Monitoring functions	<ul style="list-style-type: none"> <li>• display of all measurement values <sup>3)</sup></li> <li>• display of the daily data log and test-related data <sup>3)</sup></li> <li>• notification issued <ul style="list-style-type: none"> <li>• on data transfer and communication failure</li> <li>• on over-/undervoltage in any battery</li> <li>• on excessive voltage deviation from average</li> <li>• on over-/undertemperature in any battery</li> <li>• on excessive temperature deviation from average</li> </ul> </li> </ul>
Other functions	<ul style="list-style-type: none"> <li>• operation hour counter for each battery</li> <li>• histogram analysis for assessment of the operation conditions of each battery <sup>4)</sup></li> </ul>

## BAT-LOGG® Sensor

Operating voltage	12V (nominal) from lead-acid battery
LED indicator	measurement activity + battery voltage <sup>5)</sup>
Measurements (W x H x D)	38mm x 34mm x 10mm
Protection marking acc. DIN EN 60529	IP 40
Protection class acc. IEC 61140	II
Flammability of housing material acc. UL94	V-0
Connection / mounting	<ul style="list-style-type: none"> <li>• connection to battery poles with 6mm Faston connectors <sup>6)</sup></li> <li>• glue to battery housing <sup>7)</sup></li> </ul>
Connection cable	double-isolated, short-circuit proof cable, length: approx. 28cm <sup>8)</sup>
Average current consumption	< 0,2mA (1,76Ah/year)
Mounting location requirements	degree of pollution rated 1 or 2 acc. EN 50178

## BAT-LOGG® Interface

Operating voltage	216V DC or 230V AC (nominal)
Supported number of batteries	max. 160 BAT-LOGG® Sensor modules
Interfaces	<ul style="list-style-type: none"> <li>• 2 serial COM communication interfaces for data exchange</li> <li>• single-pole switchover relais contact for collective fault indication</li> </ul>
LED indicators	<ul style="list-style-type: none"> <li>• collective fault (red)</li> <li>• COM-communication (green)</li> <li>• measurement data receival (green)</li> <li>• power on (green)</li> </ul>
Measurements (W x H x D)	157mm x 85mm x 60mm (DIN hatrail module, 31 HP)
Mounting location requirements	<ul style="list-style-type: none"> <li>• degree of pollution rated 1 acc. EN 50178</li> <li>• for nominal system voltages &gt; 216 V DC, an additional protection cover is required</li> </ul>

*Annotations: 1) Measured on the outer side of each battery. 2) Lowest voltage measured in each discharging cycle. 3) Functions available only in connection with emergency lighting systems of type midiControl and multiControl running firmware version 1.7.9 or higher. Full functionality is available through the Web-Interface of the system; part of the functionality is not available in the LCD menu for technical reasons. 4) Separately counting the operating hours for which voltage and temperature were inside pre-defined ranges (six voltage and six temperature ranges); these values allow for a verification of the thermal conditions and the charging/discharging operation of each battery. 5) LED flashing signals the carrying-out of a measurement and the transmission of the measured values. LED flashing twice: battery voltage is > 10,8V; LED flashing once: battery voltage is ≤ 10,8V. 6) Connecting tabs for M5/6/8 screw poles are included with the modules. 7) Double-sided adhesive strips are included with the modules. 8) Cable with Faston connector, connected to the module.*

### Benefits from using BAT-LOGG®

The BAT-LOGG® system can be installed quickly and inexpensively. Through automatic measuring, it saves valuable working time during the regular on-site inspection, and guarantees traceable measurement data without gap over each battery's entire period of use.

Other benefits: Less on-site operations, no more routine measurements, reduced time for traveling and maintenance, reduced operational hazards (such as electric shock), price advantage for the end user.



The table below helps you selecting the correct system configuration: First, find the total number of circuits of your system in the leftmost column. The column „System Type“ shows you the matching system types. Now, in the column corresponding to the required Supply Time (1h/3h/8h), look for the row showing a battery power (value in Watts to the left of the slash\*) greater than or equal to the required total DC power consumption of the planned system. The value to the right of the slash now gives the number of charger modules the system must have\*\*, while the right-most column shows you the Battery Type required\*\*\*.

\* Maximum actual total DC power consumption of the planned system.

\*\* The number of charger modules given ensures that the batteries will be re-charged to 80% of their nominal capacity within 12 hours according to EN 50171

\*\*\* This battery type selection takes into account 25% of additional reserve as required by EN 50171. System Types and Battery types can only be combined as given in the table. Thus, even for a smaller number of circuits, a bigger system type might be required.

Mains circuits	System type	Supply time			Battery
		1h	3h	8h	
≤ 4	myControl plus	691 W / 1 LDM	276 W / 1 LDM	104 W / 1 LDM	OGiV 1252 LP
≤ 6	microControl plus	691 W / 1 LDM	276 W / 1 LDM	104 W / 1 LDM	OGiV 1252 LP
≤ 12 (≤ 32)	miniControl (XL) plus	715 W / 1 LDM	284 W / 1 LDM	131 W / 1 LDM	OGiV 12170 LP
≤ 32	midiControl plus	2.592 W / 1 LDM	1.201 W / 1 LDM	523 W / 1 LDM	OGiV 12260 LP
		2.514 W / 1 LDM	1.236 W / 1 LDM	569 W / 1 LDM	OGiV 12280 L
		3.309 W / 1 LDM	1.313 W / 1 LDM	626 W / 1 LDM	OGiV 12330 LP
		4.035 W / 1 LDM	1.693 W / 1 LDM	697 W / 2 LDM	OGiV 12400 LP
		4.519 W / 1 LDM	1.901 W / 1 LDM	841 W / 2 LDM	OGiV 12450 LP
		5.883 W / 1 LDM	2.604 W / 2 LDM	1.264 W / 2 LDM	OGiV 12550 LP
≤ 96	multiControl plus	5.936 W / 2 LDM	2.609 W / 2 LDM	1.152 W / 2 LDM	OGiV 12600 LP
		6.281 W / 2 LDM	2.687 W / 2 LDM	1.232 W / 2 LDM	OGiV 12650 LP
		7.275 W / 2 LDM	3.283 W / 2 LDM	1.452 W / 2 LDM	OGiV 12750 LP
		7.430 W / 2 LDM	3.283 W / 2 LDM	1.598 W / 3 LDM	OGiV 12800 LW/LPL
		8.208 W / 2 LDM	3.732 W / 2 LDM	1.702 W / 3 LDM	OGiV 12900 LP
		10.195 W / 2 LDM	4.190 W / 3 LDM	1.970 W / 3 LDM	OGiV 121000 LP
		11.491 W / 3 LDM	4.596 W / 3 LDM	2.160 W / 4 LDM	OGiV 121200 LPS
		12.960 W / 3 LDM	5.892 W / 3 LDM	2.540 W / 4 LDM	OGiV 121340 LP
		14.688 W / 3 LDM	6.160 W / 4 LDM	2.825 W / 4 LDM	OGiV 121500 LP
		21.514 W / 4 LDM	9.590 W / 5 LDM	4.320 W / 6 LDM	OGiV 122000 LP
		29.016 W / 5 LDM	12.834 W / 6 LDM	6.228 W / 7 LDM	OGiV 122600 LP



 **Made**  
 **in**  
 **Germany**

**RP-Technik GmbH**  
PART OF RP-GROUP

**Headquarters/Production**  
Hermann-Staudinger-Str. 10 – 16  
63110 Rodgau

**Fon** +49 6106 660 28-0  
**E-Mail** info@rp-group.com

**Systems production**  
Mittlerer Watzenbach 3  
07318 Saalfeld

**Fon** +49 3671 52 85-0  
**Fax** +49 3671 52 85-20

Follow us  



[www.rp-group.com](http://www.rp-group.com)